

tzplot.sty

Plot Graphs with TikZ Abbreviations

In-Sung Cho
ischo <at> ktug.org

Economics, Kongju National University
2022/10/04 version 2.11

Abstract

This is a L^AT_EX package that provides TikZ based macros to make it easy to draw graphs. The macros provided in the tzplot package are just *abbreviations* for TikZ codes, which can be complicated, but using the package, hopefully, makes drawing easier, especially when drawing repeatedly. The macros have been chosen and developed with an emphasis on drawing graphs in *economics*.

KEYWORDS: lines, dots, curves, axes, functions, projection, ticks, intersections, tangent lines

Contents

Part I	Preliminaries	1
1	Introduction	1
1.1	About tzplot.sty	1
1.2	Preoccupied style names	2
1.3	How to read this document	3
2	Changes	3
2.1	What's New in version 2.11	3
2.2	What's New in version 2.1	3
2.3	What's New in version 2.0	4
2.3.1	New macros	4
2.3.2	Extending paths: \tz<...>AtBegin and \tz<...>AtEnd	4
2.3.3	New coordinates	4
2.3.4	Error messages	5
2.3.5	Abridged strings to place labels for coordinates, dots, and points	5
2.3.6	New styles for middle arrow tips	5
2.4	Remarks	6
Part II	Getting Started	7
3	An Intuitive Introduction I: Basics	7
3.1	Lines: Basics: \tzline(0,0)(3,1)	7
3.2	Dots: Basics	7
3.2.1	A circle dot: \tzcdot(0,0)	7
3.2.2	A circle node dot: \tzndot(0,0)	8
3.2.3	Difference between \tzcdot and \tzndot	8
3.3	Coordinates: Basics: \tzcoor(0,0)(A)	9
3.4	Curves: Basics	10

3.4.1	<code>\tzto(0,0)(4,2)</code>	10
3.4.2	<code>\tzbezier</code>	10
3.4.3	<code>\tzparabola</code>	10
3.5	Adding text: Nodes and placement	11
3.5.1	<code>\tznode(3,1){text}[right]</code>	11
3.5.2	Review: Main nodes and label nodes in <i>TikZ</i>	11
3.5.3	Abbreviations of <i>TikZ</i> basic placement option styles: <code>a</code> , <code>r</code> , <code>ar</code> , <code>bl</code> , etc.	12
3.6	Labeling dots and coordinates	12
3.6.1	<code>\tzdot</code> , <code>\tzcdot</code>	12
3.6.2	<code>\tzcoor</code>	12
3.6.3	<code>\tzcoor*</code>	13
3.7	Adding text next to lines or curves	13
3.7.1	<code>\tzline</code>	13
3.7.2	<code>\tzto</code>	14
3.7.3	<code>\tzbezier</code>	14
3.7.4	<code>\tzparabola</code>	15
4	An Intuitive Introduction II: Repetition of Coordinates	15
4.1	Linking many coordinates: Semicolon versions	15
4.1.1	<code>\tzlines</code> : Connected line segments	15
4.1.2	<code>\tzpolygon</code> , <code>\tzpolygon*</code> : Closed paths	16
4.1.3	<code>\tzpath*</code> : Filling area	17
4.2	Many dots: Semicolon versions	18
4.2.1	<code>\tzcdots(*)</code>	18
4.2.2	<code>\tzdots(*)</code>	18
4.3	Many coordinates: Semicolon versions	19
4.3.1	<code>\tzcoors</code> , <code>\tzcoors*</code>	19
4.3.2	<code>\tzcoorsquick</code>	20
4.3.3	<code>\tzcoorsquick*</code>	20
4.4	<code>plot</code> coordinates: Semicolon versions	21
4.4.1	<code>\tzplot*</code> : Mark dots with <code>[mark=*]</code>	21
4.4.2	<code>\tzplot</code> : Lines with <code>[tension=0]</code>	21
4.4.3	<code>\tzplot*[draw]</code> : Lines with dots	22
4.4.4	<code>\tzplotcurve</code> : Curves with <code>[smooth,tension=1]</code>	22
5	An Intuitive Introduction III: Plotting Functions	23
5.1	Axes	23
5.1.1	<code>\tzaxes</code>	23
5.1.2	<code>\tzaxes*</code>	23
5.1.3	<code>\tzshoworigin</code> , <code>\tzshoworigin*</code>	24
5.1.4	<code>\tzaxisx</code> , <code>\tzaxisy</code>	24
5.2	Ticks	25
5.2.1	<code>\ztzticks</code>	25
5.2.2	<code>\ztzticks*</code>	25
5.2.3	<code>\ztzticksx(*)</code> , <code>\ztzticksy(*)</code>	26
5.3	Projections on the axes	26
5.3.1	<code>\tzprojx(*)</code> , <code>\tzprojy(*)</code>	26
5.3.2	<code>\tzproj(*)</code>	27
5.4	Plot functions	27
5.4.1	<code>\tzfn</code>	27
5.4.2	<code>\tzhfnat</code> , <code>\tzhfn</code> : Horizontal lines	28
5.4.3	<code>\tzvfnat</code> , <code>\tzvfn</code> : Vertical lines	28
5.4.4	<code>\tzLFn</code> : Linear functions	29
5.5	Intersection points	29
5.5.1	Naming paths	29
5.5.2	<code>\tzXpoint(*)</code> : Intersection points of two paths	29
5.5.3	<code>\tzvXpointat(*)</code> , <code>\tzvXpoint(*)</code> : Vertical intersection points	30

5.5.4	<code>\tzhXpointat(*)</code> , <code>\tzhXpoint(*)</code> : Horizontal intersection points	30
5.6	Tangent lines and secant lines	31
5.6.1	<code>\tztangentat</code>	31
5.6.2	<code>\tztangent</code>	31
5.6.3	<code>\tzsecantat</code> , <code>\tzsecant</code>	32
6	Examples: Economics	33
6.1	Markets	33
6.1.1	Market equilibrium: step by step	33
6.1.2	Tax incidence: step by step	34
6.2	Firms	35
6.2.1	Cost curves	35
6.2.2	Equilibrium of a competitive firm	35
6.2.3	Monopoly equilibrium	36
6.3	Consumers: Budget lines and indifference curves	36
6.4	Production Possibility Curves	37
6.5	Edgeworth box	37
6.6	Growth	37
6.7	Liquidity trap	38
6.8	Miscellany	39
	Part III Points, Lines, Curves, and Angles	40
7	Getting Ready	40
7.1	Styles: <code>tzdotted</code> , <code>tzdashed</code> , <code>tzhelplines</code>	40
7.2	<code>\tzhelplines</code> , <code>\tzhelplines*</code>	40
7.3	<code>\tzbbox</code> : A bounding box	41
8	Dots	42
8.1	<code>\tzcdot(*)</code> : A small circle	42
8.2	<code>\tzcdots(*)</code> : Multiple circle dots	44
8.3	<code>\tzdot(*)</code> : A single node dot	46
8.3.1	THREE WAYS to change the size of node dots	46
8.3.2	How to label	47
8.3.3	How to change colors and shapes	48
8.3.4	How to move: <code>shift</code>	48
8.3.5	Comparison: <code>\tzdot</code> and <code>\tzcdot</code>	49
8.4	<code>\tzdots(*)</code> : Multiple node dots	49
9	Coordinates	52
9.1	<code>\tzcoor</code> and <code>\tzcoor*</code>	52
9.1.1	<code>\tzcoor</code>	52
9.1.2	<code>\tzcoor*</code>	53
9.2	<code>\tzcoors</code> and <code>\tzcoors*</code> : Semicolon versions	54
9.2.1	<code>\tzcoors</code>	54
9.2.2	<code>\tzcoors*</code>	55
9.3	<code>\tzcoorsquick</code> and <code>\tzcoorsquick*</code> : Semicolon versions	56
9.3.1	<code>\tzcoorsquick</code>	56
9.3.2	<code>\tzcoorsquick*</code>	56
9.4	<code>\tzgetxyval</code>	57
9.5	<code>\tzcoortangenttocircle(*)</code>	58
10	Plot Coordinates: <code>\tzplot</code>: Semicolon Versions	58
10.1	<code>\tzplot</code> and <code>\tzplot*</code> : Syntax	58
10.2	<code>\tzplot*</code> : Dots and marks	59
10.3	<code>\tzplot</code> : Lines	61

10.4	<code>\tzplot</code> : Curves	63
10.5	<code>\tzplot</code> : Bars and combs	63
10.6	<code>\tzplotcurve(*)</code>	64
11	Nodes	67
11.1	<code>\tznode</code> and <code>\tznode*</code>	67
11.2	<code>\tznodes</code> and <code>\tznodes*</code> : Semicolon versions	69
11.3	<code>\tznodedot(*)</code>	71
11.4	<code>\tznodedots(*)</code> : Semicolon versions	72
11.5	<code>\tznodeframe</code> and <code>\tznodeframe*</code>	74
11.6	<code>\tznodecircle</code> and <code>\tznodecircle*</code>	75
11.7	<code>\tzcoortangenttocircle(*)</code>	77
11.8	<code>\tznodeellipse</code> and <code>\tznodeellipse*</code>	78
12	Lines	78
12.1	<code>\tzline</code> : Connecting two points	78
12.1.1	Line styles	79
12.1.2	Adding text	79
12.1.3	Moving lines: <code>shift</code>	80
12.1.4	Extending paths	80
12.1.5	Naming paths: Intersection points	81
12.2	<code>\tzline+</code> : Relative coordinates	81
12.3	Styles: <code>tzshorten</code> and <code>tzextend</code>	82
12.4	<code>\tzlines</code> : Connecting multiple points: Semicolon version	82
12.5	<code>\tzlines+</code> : Relative coordinates: Semicolon version	85
13	Connecting Points	87
13.1	<code>\tzto</code> : Two points	87
13.2	<code>\tzto+</code> : Relative coordinates	89
13.3	<code>\tztos</code> : Multiple points: Semicolon version	89
13.4	<code>\tztos+</code> : Relative coordinates: Semicolon version	92
13.5	<code>\tzlink</code> : Two points	92
13.6	<code>\tzlinks</code> : All in one: Semicolon versions	95
13.6.1	<code>\tzlinks</code> : Standard version	95
13.6.2	<code>\tzlinks+</code> , <code>\tzlinks*</code> , <code>\tzlinks**</code> : Variants	97
13.6.3	Putting text, shift, intersections, and extending paths	98
14	Filling Area	100
14.1	<code>\tzpath</code> : Semicolon version	100
14.2	<code>\tzpath*</code> : Semicolon version	102
14.3	<code>\tzpath+</code> and <code>\tzpath**</code> : Relative coordinates: Semicolon versions	103
15	Curves	104
15.1	Bézier curves	104
15.1.1	<code>\tzbezier</code>	104
15.1.2	<code>\tzbezier+</code> : Relative coordinates	106
15.2	Parabolas	107
15.2.1	<code>\tzparabola</code>	107
15.2.2	<code>\tzparabola+</code> : Relative coordinates	109
15.3	Edges	110
15.3.1	<code>\tzedge(+)</code>	110
15.3.2	<code>\tzedges(+)</code> : Semicolon versions	111
15.4	More curves	113
15.4.1	<code>\tzplotcurve</code> , <code>\tzplot</code>	113
15.4.2	<code>\tzto</code> , <code>\tztos</code>	113
15.4.3	<code>\tzlink</code> , <code>\tzlinks</code>	113
15.4.4	<code>\tzfn</code>	114

16	Polygons and Circles	115
16.1	Polygons: <code>\tzpolygon</code> : Semicolon versions	115
16.1.1	<code>\tzpolygon</code>	115
16.1.2	<code>\tzpolygon*</code>	116
16.1.3	<code>\tzpolygon+</code> , <code>\tzpolygon**</code> : Relative coordinates: Semicolon versions	116
16.2	Rectangles	117
16.2.1	<code>\tzframe</code> and its variants	117
16.2.2	<code>\tzrectanglering(*)</code>	118
16.3	Circles and rings	120
16.3.1	<code>\tzcircle(*)</code>	120
16.3.2	<code>\tzring(*)</code>	121
16.4	Ellipses	123
16.4.1	<code>\tzellipse(*)</code>	123
16.4.2	<code>\tzellipsering(*)</code>	124
17	Arcs, Wedges, and Angle Marks	125
17.1	<code>\tzarc(')</code> : Centered arcs	125
17.1.1	Arcs	125
17.1.2	Elliptical arcs	127
17.2	<code>\tzarcfrom(')</code> : Arcs as in <i>TikZ</i>	127
17.3	<code>\tzarcsfrom</code> : Connected arcs: Semicolon version	128
17.4	Wedges	129
17.4.1	<code>\tzwedge(')</code>	129
17.4.2	<code>\tzwedge*(')</code>	130
17.5	Angle marks	131
17.5.1	<code>\tzpointangle</code> : Angles between points	131
17.5.2	<code>\tzanglemark(')</code> : Angle marks	132
17.5.3	<code>\tzanglemark*(')</code> : Fill angle marks	134
17.5.4	<code>\tzrightanglemark</code> : Right angle marks	135
17.5.5	<code>\tzrightanglemark*</code> : Fill right angle marks	136
17.6	<code>\tzdistance</code> : Distances and changes	137
Part IV	Plotting Graphs	139
18	Axes	139
18.1	Draw axes	139
18.1.1	<code>\tzaxes</code>	139
18.1.2	<code>\tzaxes*</code>	140
18.2	<code>\tzaxisx</code> and <code>\tzaxisy</code>	141
18.3	Display the origin	142
18.3.1	<code>\tzshoworigin</code>	142
18.3.2	<code>\tzshoworigin*</code>	143
18.4	<code>\tzaxesL(')</code> : L-type axes	144
19	Ticks	145
19.1	<code>\ztzticks</code> : Tick labels	145
19.2	<code>\ztzticks*</code> : Tick marks	147
19.3	<code>\ztzticksx(*)</code> and <code>\ztzticksy(*)</code>	147
20	Projections	149
20.1	<code>\tzproj(*)</code> : Projections on the axes	149
20.2	<code>\tzprojx(*)</code> and <code>\tzprojy(*)</code>	150
20.3	<code>\tzprojs(*)</code> : Semicolon versions	151
20.4	<code>\tzprojx(*)</code> and <code>\tzprojy(*)</code> : Semicolon versions	152
21	Plot Functions	153

21.1	<code>\tzfn</code> and <code>\tzfn'</code> : Plot functions and inverse functions	153
21.1.1	<code>\tzfn</code>	153
21.1.2	Inverse functions: <code>\tzfn'</code>	153
21.1.3	Define and name functions	154
21.1.4	Name paths: <code>name path</code>	155
21.1.5	Move graphs: <code>shift</code>	155
21.1.6	Extend paths: <code><code.append></code> , <code>\tzfnAtBegin</code> , <code>\tzfnAtEnd</code>	156
21.2	<code>\tzfnofy</code> and <code>\tzfnofy'</code> : Functions of variable y	157
21.3	Horizontal lines	158
21.3.1	<code>\tzhfnat</code>	158
21.3.2	<code>\tzhfn</code>	159
21.4	Vertical lines	160
21.4.1	<code>\tzvfnat</code>	160
21.4.2	<code>\tzvfn</code>	161
22	Plot Linear Functions	161
22.1	<code>\tzLFn</code> : Plot linear functions	161
22.1.1	<code>\tzLFn</code> and <code>\tzLFn'</code>	161
22.1.2	<code>\tzLFnofy</code> and <code>\tzLFnofy'</code>	163
22.2	<code>\tzdefLFn</code>	164
22.3	<code>\tzdefLFnofy</code>	164
23	Some More Functions	166
23.1	<code>\tzpdfN(*)</code> and <code>\tzpdfZ</code> : Normal distributions	166
23.2	<code>\tzfnarea(*)</code> : Fill under the graph	167
23.2.1	<code>\tzfnarea(*)</code>	167
23.2.2	<code>\tzfnarealine(')</code>	168
23.3	Envelope curves	170
23.3.1	<code>\tzfnmax</code> : Upper envelope curves	170
23.3.2	<code>\tzfnmin</code> : Lower envelope curves	170
24	Intersections	171
24.1	<code>\tzXpoint(*)</code> : Intersection points	171
24.2	Vertical intersection points	172
24.2.1	<code>\tzvXpointat(*)</code>	172
24.2.2	<code>\tzvXpoint(*)</code>	173
24.3	Horizontal intersection points	174
24.3.1	<code>\tzhXpointat(*)</code>	174
24.3.2	<code>\tzhXpoint(*)</code>	175
24.4	<code>\tzLFnXpoint(*)</code> : Intersection point of linear functions	175
25	Secant and Tangent Lines	176
25.1	Secant lines	176
25.1.1	<code>\tzsecantat</code>	176
25.1.2	<code>\tzsecant</code>	178
25.2	Tangent lines	179
25.2.1	<code>\tztangentat</code>	179
25.2.2	<code>\tztangent</code>	181
25.3	Slope lines and normal lines	182
25.3.1	<code>\tzslopeat</code>	182
25.3.2	<code>\tzslopeat'</code>	184
25.3.3	<code>\tzslope</code>	184
25.3.4	<code>\tzslope'</code>	185
25.4	Normal lines	185
25.4.1	<code>\tznormalat</code>	185
25.4.2	<code>\tznormalat'</code>	186
25.4.3	<code>\tznormalat*(')</code>	187

25.4.4	<code>\tznormal</code>	188
25.4.5	<code>\tznormal'</code>	189
25.4.6	<code>\tznormal*(')</code>	189
26	Miscellany	191
26.1	Middle arrows	191
26.1.1	Controllable middle arrow tips: <code>-->--</code> and <code>\settzmidarrow</code>	191
26.1.2	Fixed middle arrow tip styles: <code>--o--</code> , <code>--x--</code> , <code>--/--</code>	192
26.2	<code>\tzbrace(')</code>	193
26.3	<code>\tzsnake(+)</code> : Snake lines (Experimental)	195
	Version history	197
	Acknowledgement	197
	Reference	197
	Index	198

Part I

Preliminaries

1 Introduction

1.1 About `tzplot.sty`

The `tzplot` package is just a collection of macros based on `TikZ` to save you time typing `TikZ` code.

What you can do with `tzplot` In `pstricks`, a line connecting two points (A) and (B) is drawn by `\psline(A)(B)`. With the package `tzplot`, you can do it by `\tzline(A)(B)`.

```
\tzline(A)(B) % is an abbreviation of:  
\draw (A) -- (B);
```

```
\tzline[blue](A)(B){my line}[r] % is an abbreviation of:  
\draw [blue] (A) -- (B) node [right] {my line};
```

Some macros in this package represent one or a few lines of code, but some represent dozens of lines of `TikZ` code.

All of the drawing macros of `tzplot` are prefixed by `\tz`. Of course, it means `TikZ`. The syntax of the `tzplot` macros comes from `tikz` and `pstricks`. However, the input mode is more like `pstricks`.

How to load To use the `tzplot` package you have to load the package in the preamble of your document as follows:

```
\usepackage{tzplot}
```

The package depends on the packages `tikz`, `xparse`, and `expl3`. And it uses the following `TikZ` libraries:

```
arrows,backgrounds,calc,intersections,patterns,plotmarks,positioning,shapes,  
decorations.pathreplacing,calligraphy
```

In the version 2, more libraries are added to the list of preloaded libraries:

```
arrows.meta, bending, % (for middle arrow tips)  
decorations.markings, % (for decoration)  
decorations.pathmorphing, % (for snaked lines)  
fpu, % (for angle computation)  
spy % (for later use)
```

More comments This package sets the basic *arrow style* to `stealth`. If you don't like this, as an alternative, you can set the style like `\tikzset{>=to}` after the `tzplot` package is loaded.

This package was originally motivated by drawing graphs in economics. Therefore, the macros in this package have been selected and developed for drawing graphs efficiently in economics. However, this package will do a good job of drawing basic graphics in any fields.

Finally, note that this is far from a `TikZ` tutorial. *To make good use of this package, you need to familiarize yourself with `TikZ`.*

1.2 Preoccupied style names

This package does not provide any environment. Since all the drawing macros prefixed by `\tz` are just abbreviations of TikZ code, you can use the macros in the `tikzpicture` environment together with any TikZ commands.

Preoccupied styles However, there are some preoccupied style names that you should not overwrite. Those are as follows:

<code>tzdot</code>	<code>tzmark</code>	<code>tzdotted</code>
<code>tzdashed</code>	<code>tzhelplines</code>	<code>tznode</code>
<code>tzshorten</code>	<code>tzextend</code>	<code>tzshowcontrols</code>

Abbreviated styles Following the manual of TikZ, this package also predefines *abbreviations* (or aliases) of TikZ's basic placement options for main nodes as follows:

```
% preoccupied (alias) styles for main node options
\tikzset{%
  a/.style={above=#1},
  b/.style={below=#1},
  c/.style={centered=#1}, % centered, not center
  l/.style={left=#1},
  r/.style={right=#1},
  al/.style={above left=#1},
  ar/.style={above right=#1},
  bl/.style={below left=#1},
  br/.style={below right=#1},
}
```

By these abbreviations (or aliases), we mean that, with the `\tzplot` package, we can use these alias styles in the `\tikzpicture` environment as follows:

```
\draw (0,0) -- (1,0) node [ar] {line}; % [ar] = [above right]
```

Layers The `tzplot` package also defines graphic layers as follows:

```
\pgfdeclarelayer{background}
\pgfdeclarelayer{behind}
\pgfdeclarelayer{above}
\pgfdeclarelayer{foreground}

\pgfsetlayers{background,behind,main,above,foreground}
```

Therefore, you can select the graphic layers in sequence: `background`, `behind`, `main`, `above`, and `foreground`. For example, you can change the layer of a straight line from `main` (default) to `background` as follows:

```
\begin{tikzpicture}
  <tzplot macros>
  <tikz macros>
  \begin{pgfonlayer}{background}
    \tzline[blue](0,0)(3,1)
  \end{pgfonlayer}
\end{tikzpicture}
```

1.3 How to read this document

In drawing graphs, too many factors are involved: line style, color, fill, label, positioning, shift, and so on. Almost all macros of this package have many arguments that control these factors. Some are mandatory and some are optional. Optional arguments are hidden when not used.

The document has three essential parts: Part II, Part III, and Part IV. Part II introduces essential macros with only frequently used options. There are many options hidden in the macros introduced in Part II. Some macros are not introduced in Part II. Part III and IV describe all the features of all macros.

You must get started with Part II. Part II is sufficient for drawing needs in most cases.

Unless you are an experienced user of TikZ, it is recommended to move on to Part III and Part IV once you become familiar with Part II. In the meantime, use Part III and Part IV for reference only. Use the list of contents and the index efficiently to find macros you need.

2 Changes

2.1 What's New in version 2.11

New macros

- `\tzcoortangenttocircle(*)`: to find the tangent points to a circle from a point

Redesigned macros

- `\tznodecircle(*)`: new options "`<path name>`" and (`<minimum size>`)

2.2 What's New in version 2.1

New macros

- `\tzdistance`: distance between two points, Δx , and Δy
- `\tzslopeat'`: opposite direction of `\tzslopeat`
- `\tzslope'`: opposite direction of `\tzslope`
- `\tznormalat`: a normal line from a point on a path
- `\tznormalat'`: opposite direction of `\tznormalat`
- `\tznormalat*`: works like `\tzslopeat`, but rotated 90 degrees
- `\tznormalat*'`: works like `\tzslopeat`, but rotated -90 degrees
- `\tznormal`: a normal line from a point on a path
- `\tznormal'`: opposite direction of `\tznormal`
- `\tznormal*`: works like `\tzslope`, but rotated 90 degrees
- `\tznormal*'`: works like `\tzslope`, but rotated -90 degrees
- `\setztznormallayer`: controls the layer of `\tznormalat` and its variants
- `\setztznormalepsilon`

Redesigned macros

- `\tzaxisx`: added the option "`<path name>`" to find the intercepts easily (by default, `axisx`)
- `\tzaxisy`: added the option "`<path name>`" to find the intercepts easily (by default, `axisy`)
- `\tzaxes`: added the option "`<path name>`" with the default `"axes"`
- `\tzaxesL`: added the option "`<path name>`" with the default `"axesL"`

2.3 What's New in version 2.0

2.3.1 New macros

New macros have been added.

- `\tzfn'`: (swap version) inverse function of `\tzfn`
- `\tzfnofy`, `\tzfnofy'`: function of `\y`
- `\tzdefLFn`, `\tzdefLFnofy`: to define linear functions
- `\tzLFn'`, `\tzLFnofy'`: linear functions
- `\tzLFnXpoint(*)`: linear function intersection points
- `\tzfnmin'`, `\tzfnmax'`: envelope curves

- `\tzfnarea(*)`, `\setztzfnarealayer`, `\tzfnarealine'`: to fill the area under graphs
- `\setztzfnarealinestyle`
- `\tzpdfZ`, `\tzpdfN(*)`: (predefined) probability density functions of a normal distribution
- `\tzprojs(*)`, `\tzprojsx(*)`, `\tzprojsy(*)`: multiple projection lines
- `\setztzpathlayer`: main layer by default

- `\tzslope`, `\tzslopeat`
- `\setztzslopelayer`, `\setztzslopeatlayer`, `\setztzslopeepsilon`

- `\tzlink(+)`, `\tzlinks(*)(+)`, `\setztzlinkstyle`, `\setztzpathstyle`
- `\tzedge(+)`, `\tzedges(+)`

- `\tznodes(*)`: multiple nodes
- `\tznodedots(*)`: multiple node dots
- `\tznoderectangle(*)`, `\tznobox(*)`, `\tznodeoval(*)`: aliases

- `\tzring(*)`, `\tzcirclering(*)`
- `\tzellipsering(*)`, `\tzovalring(*)`
- `\tzrectanglering(*)`, `\tzframering(*)`, `\tzboxring(*)`
- `\tzbox(*)`

- `\tzpointangle`: angle between points
- `\tzanglemark(*)'`, `\tzrightanglemark(*)`: angle marks
- `\tzangleresult`, `\tzangleONE`, `\tzangleTWO`: after `\tzanglemark`
- `\setztzAAlinestyle`, `\setztzanglelayer`, `\setztzAAradius`, `\setztzRAsize`.

- `\setztzmidarrow`: to control middle arrow tips
- `\tzsnake`: snake lines

2.3.2 Extending paths: `\tz<...>AtBegin` and `\tz<...>AtEnd`

- `\tztoAtBegin`, `\tztoAtEnd`, `\tztosAtBegin`, `\tztosAtEnd` (version 1)
- `\tztoAtBegin`, `\tztoAtEnd`, `\tztosAtBegin`, `\tztosAtEnd` (version 1)
- `\tzlineAtBegin`, `\tzlineAtEnd`, `\tzlinesAtBegin`, `\tzlinesAtEnd`
- `\tzlinkAtBegin`, `\tzlinkAtEnd`, `\tzlinksAtBegin`, `\tzlinksAtEnd`
- `\tzbezierAtBegin`, `\tzbezierAtEnd`
- `\tzparabolaAtBegin`, `\tzparabolaAtEnd`

- `\tzvfn(at)AtBegin`, `\tzvfn(at)AtEnd`
- `\tzhfn(at)AtBegin`, `\tzhfn(at)AtEnd`

- `\tzfnAtBegin`, `\tzfnAtEnd` (version 1)
- `\tzfnofyAtBegin`, `\tzfnofyAtEnd`
- `\tzLFnAtBegin`, `\tzLFnAtEnd`
- `\tzLFnofyAtBegin`, `\tzLFnofyAtEnd`
- `\tzfnminAtBegin`, `\tzfnminAtEnd`, `\tzfnmaxAtBegin`, `\tzfnmaxAtEnd`
- `\tzplotAtBegin`, `\tzplotAtEnd`, `\tzplotcurveAtBegin`, `\tzplotcurveAtEnd`

2.3.3 New coordinates

- `(tzAAmid)`: angle arc midpoint, depending on `\tzanglemark`
- `(tzRAvertex)`: right angle mark vertex, depending on `\tzrightanglemark`

2.3.4 Error messages

Some macros, called *semicolon versions*, accept any number of coordinates. You MUST indicate when the coordinate iteration ends with a *semicolon* ;. Without the semicolon, an error occurs with the *error message*:

```
! Package tzplot Error: You may have forgotten a semicolon here or above!
```

Knowing two coordinates, you can use `\tzLFn` and related macros to graph a linear function through the two points without writing an explicit function. If you inadvertently try *infinite* slopes, you will get an error with the *error message*:

```
! Package tzplot Error: Perhaps you are trying an 'infinite slope' here or above!
```

2.3.5 Abridged strings to place labels for coordinates, dots, and points

In TikZ, a label to a main node is placed by the `label` option. The syntax of the `label` option is `label={[<label opt>]<angle>:{<label>}}`. In TikZ, The position of labels is specified by *angles*. The positioning words like *above*, *below*, *below right*, and so on can be used and they are interpreted in TikZ as the corresponding angles.

Just to avoid frequent coding errors, from the version 2, the `tzplot` package provides the *abridged strings* `a`, `b`, `c`, `br`, and so on that you can use instead of angles. With the `tzplot` package, the user input `a` is replaced by *above*, `[b]` by *below*, `c` by *center* (*not centered* for the main node option), `br` by *below right*, and similarly for other abridged strings.

Remark: This is just a *string replacement* that is not related to the function of TikZ. By this we mean that we *cannot use* these abridged strings to place labels, instead of angles, in the `tikzpicture` environment without using the related `\tz<...>` macros.

The macros related to this issue are as follows:

- dots: `\tzdot(s)`, `\tzcdots(s)`, `\tznodedot(s)`
- coordinates: `\tzcoor(s)`, `\tzcoorsquick`
- intersection points: `\tzXpoint`, `\tzvXpoint`, `\tzhXpoint`, `\tzLFnXpoint`
- plot coordinates: `\tzplot`, `\tzplotcurve`
- and their starred versions.

2.3.6 New styles for middle arrow tips

Some styles for drawing the the *middle arrow tips* on a path are predefined.

- `-->--`: (controllable) middle arrow tip
 - `\settzmidarrow` controls the positions and styles of middle arrow tips
- `--o--`: the circle middle arrow tip
- `--x--`: the cross middle arrow tip
- `--/--`: the diagonal middle arrow tip

You can use these styles to draw middle arrow tips as follows:

```
\tzlines[-->--,red](0,0)(1,0)(3,1);           % default=0.5
\tzlines[-->---=0.7](0,0)(1,0)(3,3);         % work like
\draw[-->--,red](0,0) -- (1,0) -- (3,1);
\draw[-->---=0.7](0,0) -- (1,0) -- (3,1);
```

2.4 Remarks

Some macros have been modified in order to add new features. This does not cause any harm to existing users.

- `\tznode`: to add new option `<node.code>`
 - This allows you to use full features (including `foreach`) of the TikZ’s node operation.
- `\tzframe`, `\tzcircle`, `\tzellipse`: to add new option `<code.append>`
 - Now you can use `even odd rule` to draw rings with these macros.

Some macros are “experimental” and their syntax may change in the future.

Styles of middle arrow tips in the `istgame` package The package `istgame` to draw game trees predefines the styles of the middle arrow tips including `->`, `-o->`, and `-x-`.

- The style `->` defined in `istgame` and `-->--` defined in `tzplot` are a little different from each other in the default values.
 - Still you may want to use the style `->` instead of `-->--`. In that case, you can do like this:

```
\tikzset{->/ .style={-->--}}
```
 - *However*, it is important to understand that changing the style to `->` may override the style of `->` defined in other package, depending on which package is loaded first.
 - The best way to use `->` instead of `-->--` is to upload the `istgame` and follow the instruction of the manual.
- The styles `--o--` and `--x--` differ in definition and usage from the styles `-o-` and `-x-` of the `istgame` package.

Part II

Getting Started

3 An Intuitive Introduction I: Basics

All drawing macros provided in this package work within `tikzpicture` environment, just like any other TikZ commands.

3.1 Lines: Basics: `\tzline(0,0)(3,1)`

To draw a line from $(0,0)$ to $(3,1)$, just do `\tzline(0,0)(3,1)`.

```
% \tzline
\begin{tikzpicture}
\tzhelplines(4,2)
\tzline(0,0)(3,1)
\end{tikzpicture}
```

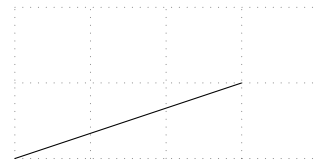

You can use TikZ options to change the style of a line.

```
% \tzline: change line style
\begin{tikzpicture}
\tzhelplines(4,3)
\tzline(0,0)(3,1)
\tzline[dashed](0,1)(3,2)
\tzline[->,blue,thick](0,3)(4,1)
\end{tikzpicture}
```

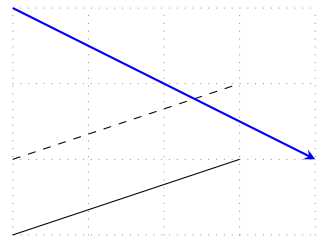

```
\tzline[dashed](0,1)(3,2) % works like:
\draw [dashed] (0,1) -- (3,2);
```

3.2 Dots: Basics

3.2.1 A circle dot: `\tzcdot(0,0)`

`\tzcdot(0,0)` prints a ‘circle dot’ \circ , with the *radius* 1.2pt by default, at the point $(0,0)$. The starred version `\tzcdot*` prints a filled dot \bullet .

```
% \tzcdot: circle dot
\begin{tikzpicture}
\tzhelplines(4,3)
\tzcdot(0,0)
\tzcdot*(3,1)
\tzcdot [red] (0,1)(3pt) % radius=3pt
\tzcdot*[green] (3,2)(3pt) % radius=3pt
\end{tikzpicture}
```

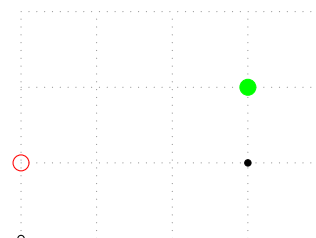

You can change the size of a dot by specifying the *radius* of the circle, like, for example, `\tzcdot(0,0)(3pt)`.

```
\tzcdot*[green](3,2)(3pt) % is an abbreviation for:
\draw [fill,green] (3,2) circle (3pt);
```

```
% \tzcdot
\begin{tikzpicture}
\tzhelplines(4,3)
\tzcdot(0,0) \tzcdot*(3,1)
\tzcdot[red](0,1)(2mm) % radius=2mm
\tzcdot*[green](3,2)(3pt) % radius=3pt
\tzline(0,0)(3,1)
\tzline(0,1)(3,2)
\end{tikzpicture}
```

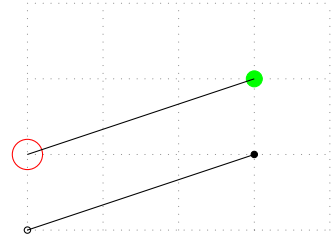

3.2.2 A circle node dot: \tzdot(0,0)

\tzdot draws a ‘circle node dot’ at a specified coordinate. The starred version \tzdot* prints a filled dot. The default size (*diameter* or *minimum size*) is 2.4pt.

```
% \tzdot: node dot
\begin{tikzpicture}
\tzhelplines(4,3)
\tzdot(0,0) \tzdot*(3,1)
\tzdot[red](0,1)(4mm) % minimum size=4mm
\tzdot*[green](3,2)(6pt) % minimum size=6pt
\tzline(0,0)(3,1)
\tzline(0,1)(3,2)
\end{tikzpicture}
```

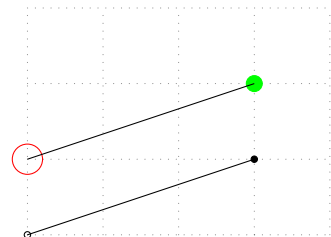

The size (*diameter* or *minimum size*) of a node dot can be changed by the second (or the last) parenthesis option, like (6pt).

```
% \tzcdot
\begin{tikzpicture}
\tzhelplines(4,3)
\tzdot(0,0)(5pt) \tzdot*(3,1)
\tzdot[red](0,1)(4mm) \tzdot*[green](3,2)(6pt)
\tzline(0,0)(3,1)
\tzline(0,1)(3,2)
\end{tikzpicture}
```

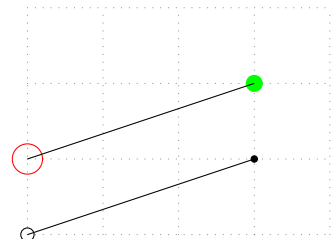

```
\tzdot[green](0,0)(6pt) % works like:
\draw [green] (0,0) node [tzdot,minimum size=6pt] {};
% tzdot style is predefined
```

3.2.3 Difference between \tzcdot and \tzdot

A ‘circle dot’ drawn by \tzcdot is affected by *xscale* or *yscale* in TikZ, but a ‘circle node dot’ drawn by \tzdot is not. Note also that \tzcdot controls the *radius* of a circle dot (following TikZ practice), while \tzdot controls the *diameter* of a circle node dot.

```

% \tzdot: size not changed by scaling
\begin{tikzpicture}[xscale=.5,yscale=1.1] %%
\tzhelplines(4,3)
\tzdot(0,0)           \tzdot*(3,1)
\tzdot[red](0,1)(4mm) \tzdot*[green](3,2)(6pt)
\tzline(0,0)(3,1)
\tzline(0,1)(3,2)
\end{tikzpicture}

```

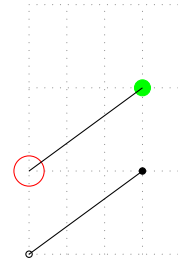

Remark: The circle dots drawn by `\tzcdot` are affected by TikZ scale factors. It gets bigger or smaller by `scale`. Let us see what happens to circle dots, especially when `xscale` and `yscale` are not symmetric.

```

% \tzcdot: distorted
\begin{tikzpicture}[xscale=.5,yscale=1.1] %%
\tzhelplines(4,3)
\tzcdot(0,0)           \tzcdot*(3,1)
\tzcdot[red](0,1)(2mm) \tzcdot*[green](3,2)(3pt)
\tzline(0,0)(3,1)
\tzline(0,1)(3,2)
\end{tikzpicture}

```

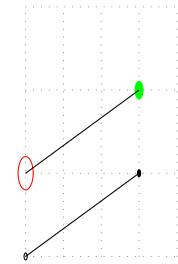

3.3 Coordinates: Basics: `\tzcoor(0,0)(A)`

To define a coordinate, use `\tzcoor` with a coordinate followed by its name in parentheses.

```

\tzcoor(0,0)(A) % works like:
\path (0,0) coordinate (A);
% or
\coordinate (A) at (0,0);

```

```

\begin{tikzpicture}
\tzhelplines(4,3)
\tzcoor(0,0)(A)   \tzcoor(60:3cm)(B)
\tzline[->](A)(B)
\tzdot(A)(5pt)
\tzcoor(0,1)(C)   \tzcoor(4,2)(D)
\tzline[dashed](C)(D)
\end{tikzpicture}

```

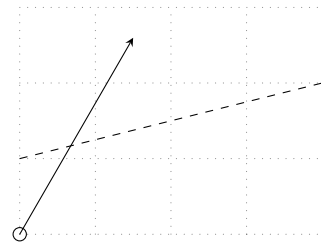

The starred version `\tzcoor*` prints a filled node dot at a specified coordinate.

```

\begin{tikzpicture}
\tzhelplines(4,3)
\tzcoor(0,0)(A)   \tzcoor(60:3cm)(B)
\tzline[->](A)(B)
\tzdot(A)(5pt)
\tzcoor*(0,1)(C)  \tzcoor*[fill=none](4,2)(D)
\tzline[dashed](C)(D)
\end{tikzpicture}

```

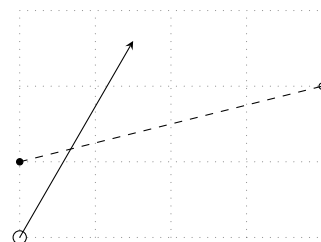

3.4 Curves: Basics

3.4.1 `\tzto(0,0)(4,2)`

`\tzto` connects two points with a line or a curve using the `to` operation of `TikZ`.

```
\begin{tikzpicture}
\tzhelplines(4,3)
\tzto(0,0)(4,2)
\tzto[bend right,dashed](0,1)(3,2)
\tzto[out=90,in=-90,->,blue](0,2)(4,1)
\end{tikzpicture}
```

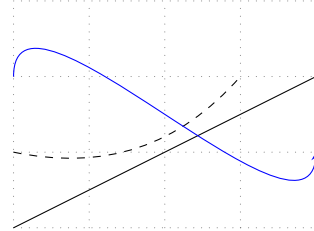

```
\tzto[bend right](0,1)(3,2) % works like:
\draw [bend right] (0,1) to (3,2);
```

3.4.2 `\tzbezier`

`\tzbezier` draws a Bézier curve with *one or two* control points from the first coordinate to the last coordinate. The style `tzshowcontrols` predefined in the package reveals the control point(s).

```
\begin{tikzpicture}
\tzhelplines(4,3)
\tzbezier[blue,thick](0,0)(2,0)(4,2)
\tzbezier[->,tzshowcontrols](0,2)(1,3)(3,0)(4,1)
\end{tikzpicture}
```

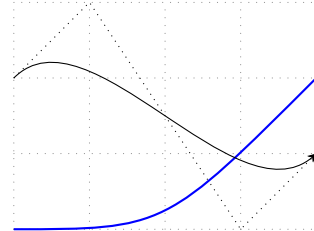

```
\tzbezier[blue](0,0)(2,0)(4,2) % works like:
\draw [blue] (0,0) .. controls (2,0) .. (4,2);
\tzbezier(0,2)(1,3)(3,0)(4,1) % works like:
\draw (0,2) .. controls (1,3) and (3,0) .. (4,1);
```

3.4.3 `\tzparabola`

`\tzparabola` draws a parabola controlled by several options of `TikZ`'s `parabola` operation. The macro `\tzparabola` accepts *two or three* coordinate arguments to draw a parabola and the parabola bends at the second coordinate if it exists.

```
\tzparabola(0,0)(2,4) % works like:
\draw (0,0) parabola (2,4);
\tzparabola(2,0)(3,3)(4,1) % works like:
\draw (2,0) parabola bend (3,3) (4,1);
```

```

\begin{tikzpicture}
\tzhelplines(4,4)
\tzparabola(0,0)(2,4)
\tzparabola[bend at end,dashed](0,0)(2,4)
\tzparabola(2,0)(3,3)(4,1)
\tzparabola[bend pos=.33,dashed](1,0)(4,4)
\end{tikzpicture}

```

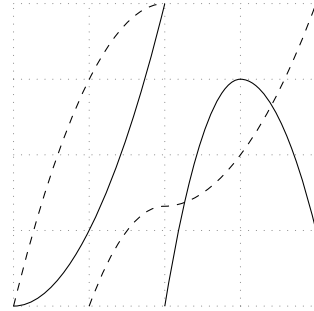

3.5 Adding text: Nodes and placement

3.5.1 \tznnode(3,1){text}[right]

With `\tznnode(<coord>){<text>}[<node opt>]`, you can put some text at a specified position. The starred version `\tznnode*` draws the node perimeter, which is a **rectangle** by default.

```

\begin{tikzpicture}
\tzhelplines(4,3)
\tznnode(0,0){A}
\tznnode*(1,1){text}
\tzdot*(2,2)
\tznnode(2,2){Text}[above right,blue]
\end{tikzpicture}

```

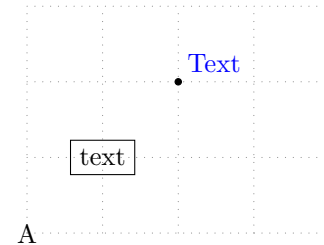

```

\tznnode(0,0){A} % works like:
\node at (0,0) {A};
\tznnode(2,2){Text}[above right,blue] % works like:
\draw (2,2) node [above right,blue] {Text};

```

3.5.2 Review: Main nodes and label nodes in TikZ

In TikZ, there are two kinds of nodes: main nodes and label nodes.

When a *main node* with text in it is placed at a specific point, its *label node* with a label in it is optionally placed in the *direction* of a designated *angle* relative to the main node.

```

\begin{tikzpicture}
\tzhelplines(4,3)
\tznnode*(2,1){main node}
[ scale=2, label={[draw,red]90:label node}]
\tznnode*(3,3){A}[label={above:a},label={0:r}]
\end{tikzpicture}

```

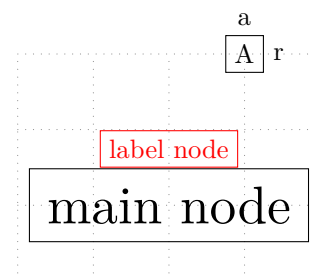

Instead of angles, you can use the corresponding placement words. In TikZ, for example, *above* is replaced by 90 degree, *right* by 0 degree, *below left* by -135 degree, and the like. Note that the angle expression *cannot* be used for placing main nodes.

Remark:

- In this package, macros related to ‘dots’ or ‘coordinates’ (like `\tzcdot`, `\tzdot`, and `\tzcoor`) can optionally have ‘label nodes,’ while macros related to ‘lines’ and ‘curves’ (like `\tzline`, `\tzto`, `\tzbezier` and `\tzparabola`) optionally have ‘main nodes’ or ‘text nodes.’

- There is one exception: `\tzshoworigin`. `\tzshoworigin` can have a label, but its location is controlled by positional words such as `below left` but not by `<angle>`. (See Section 18.3 on page 142 for more details.)

3.5.3 Abbreviations of TikZ basic placement option styles: a, r, ar, bl, etc.

You can use abbreviations (or aliases) `a` for above, `c` for centered, `r` for right, `bl` for below left, and so on to place *main nodes*. (Again, you *cannot* use angels to place main nodes.)

```
\begin{tikzpicture}[font=\ttfamily,text=blue]
\tzhelplines[thick](2,2)
\tznode(1,1){centered}[draw] % default: centered
\tznode(1,2){a} [a] \tznode(1,0){b} [b]
\tznode(0,1){l} [l] \tznode(2,1){r} [r]
\tznode(0,2){al}[al] \tznode(2,2){ar}[ar]
\tznode(0,0){bl}[bl] \tznode(2,0){br}[br]
\end{tikzpicture}
```

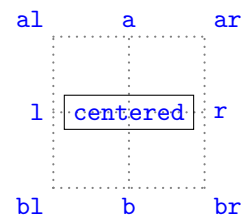

3.6 Labeling dots and coordinates

3.6.1 \tzdot, \tzcdot

To add a label to a dot generated by `\tzdot` or `\tzcdot`, you should specify, *right after a coordinate*, `{<label>}` followed by `<angle>` (90 degree or above by default in TikZ).

REMEMBER that the order of the arguments is `(<coord>){<label>}<angle>`. To change the size of a dot, you need to specify the last option (`<dimension>`) after all the other arguments.

```
\begin{tikzpicture}
\tzhelplines(4,3)
\tzdot*(1,1){A} % default: 90 or above
\tzdot(2,1){B}[0](4pt)
\tzcdot*(1,2){C}[180](2pt)
\tzcdot(3,2){D}[45]
\tzdot*(4,0){E}[[red,draw]180](4pt)
\end{tikzpicture}
```

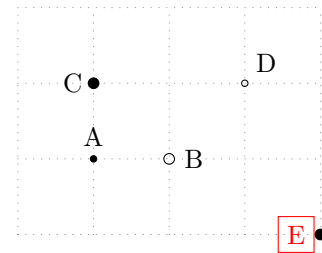

```
\tzcdot*(1,2){C}[180](2pt) % works like:
\draw[fill] (1,2) circle (2pt) node [label={180:C}] {};
```

3.6.2 \tzcoor

`\tzcoor` can add a label to a coordinate. Just append the optional arguments `{<label>}` and `<angle>` after the two mandatory parenthesis arguments.

Remark: REMEMBER the order of arguments is `(<coord>)(<name>){<label>}<angle>`.

```
% syntax: simplified
\tzcoor(<coord>)(<coord name>){<label>}[<label opt>]<angle>
% defaults
(<m>)(<m>){}[]
% <m> means 'mandatory'
```

You can see the full syntax of `\tzcoor` in Section 9.1 on page 52.

```

\begin{tikzpicture}
\tzhelplines(4,2)
\tzcoor(1,1)(A){A} % default: 90 or above
\tzcoor(2,1)(B){B}[[red]0]
\end{tikzpicture}

```

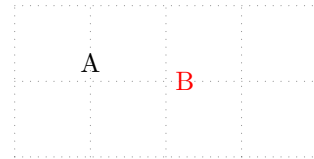

```

\tzcoor(1,1)(B){B}[0] % works like:
\draw (1,1) coordinate (B) node [label={0:B}] {};
\tzcoor(1,1)(B){B}[[red]0] % works like:
\draw (1,1) coordinate (B) node [label={{red}0:B}] {};

```

3.6.3 \tzcoor*

The starred version `\tzcoor*` designates a coordinate and prints a node dot with a label around the designated point like `\tzdot*` does.

```

% syntax: simplified
\tzcoor*{<dot opt>}<coor>(<coor name>){<label>}[[<label opt>]<angle>]<dot size>

```

```

\begin{tikzpicture}
\tzhelplines(4,3)
\tzcoor(1,1)(A){A} % default: 90 or above
\tzcoor(2,1)(B){B}[0]
\tzcoor*(1,2)(C){C}[180] (4pt)
\tzcoor*[fill=none] (3,2)(D){D}[45]
\tzcoor*(4,0)(E){E}[[red,draw]180] (4pt)
\end{tikzpicture}

```

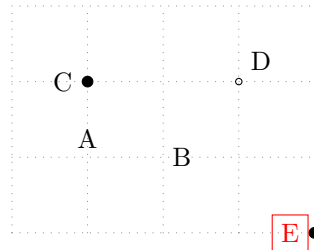

```

\tzcoor*(1,2)(C){C}[180] (4pt) % works as follows:
\tzcoor(1,2)(C)
\tzdot*(C){C}[180] (4pt)

```

3.7 Adding text next to lines or curves

3.7.1 \tzline

`\tzline` accepts two mandatory coordinates. To add text to a line segment, just specify the optional arguments `{<text>}` and `[<node opt>]` *in-between* the two coordinates. The `[<node opt>]` is `[above,midway]`, by default.

```

\begin{tikzpicture}
\tzhelplines(4,3)
\tzline(0,0){route A}(3,0)
\tzline[dashed] (1,1){route B}(4,1)
\tzline[blue]
(0,3) {plan C} [below,near end] (3,3)
\end{tikzpicture}

```

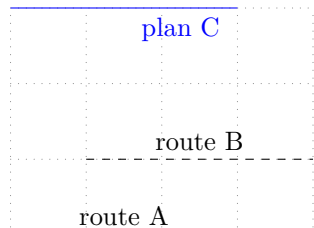

The optional argument `{<text>}` following the second coordinate can also be used as a name of the graph. By default, it is placed at the second coordinate.

```
\begin{tikzpicture}
\tzhelplines(4,3)
\tzline(0,3)(4,0){demand}
\tzline(0,0)(3,3){supply}[r]
\end{tikzpicture}
```

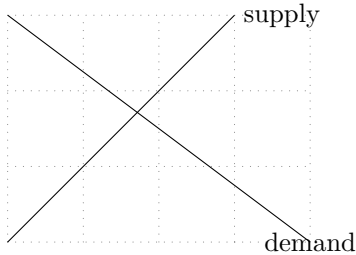

3.7.2 \tzto

To add text to a line or a curve drawn by `\tzto`, just specify the optional arguments `{<text>}` and `[<node opt>]` in-between the two coordinates. By default, the `[<node opt>]` is `[above,midway]`.

```
\begin{tikzpicture}
\tzhelplines(4,3)
\tzto(0,0){route A}(3,0)
\tzto[dashed,bend left](1,1){route B}(4,1)
\tzto[blue,bend right]
(0,3){plan C}[below,near end](3,3)
\end{tikzpicture}
```

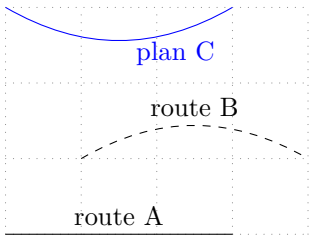

```
\tzto(0,0){route A}(3,0) % works like:
\draw (0,3) to node [above] {route A} (3,0);
```

The optional argument `{<text>}` following the second coordinate can also be used as a name of the graph. By default, it is placed at the second coordinate.

```
\begin{tikzpicture}
\tzhelplines(4,3)
\tzto[bend right=15](0,3)(4,0){demand}
\tzto[bend right=10](0,0)(3,3){supply}[r]
\end{tikzpicture}
```

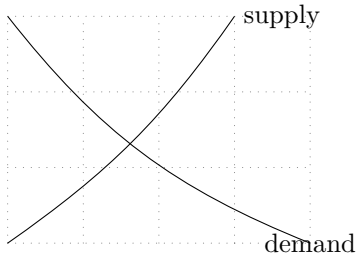

3.7.3 \tzbezier

`\tzbezier` accepts three or four coordinates as arguments. You can add text to the curve drawn by `\tzbezier` using the optional arguments `{<text>}` and `[<node opt>]` after the last coordinate.

```
\begin{tikzpicture}
\tzhelplines(4,3)
\tzbezier(0,2)(1,3)(3,0)(4,1){curve}[r]
\tzbezier[red,yshift=-5mm]
(0,2)(1,3)(3,0)(4,1){curve}[midway]
\tzbezier[green,text=blue,yshift=-10mm]
(0,2)(1,3)(3,0)(4,1){curve}[b,near end]
\end{tikzpicture}
```

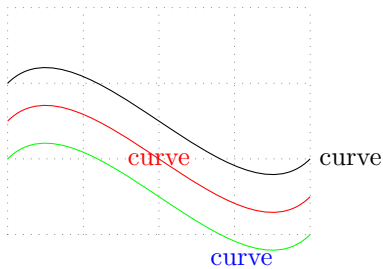

3.7.4 \tzparabola

You can add text to a parabola drawn by `\tzparabola` using the optional arguments `{<text>}` and `[<node opt>]` following the last coordinate. The text is placed at (by default) or around the last coordinate according to `[<node opt>]`.

```
\begin{tikzpicture}
\tzhelplines(4,3)
\tzparabola(0,2)(1,.5)(3,2){$AC$}[r]
\tzparabola[bend at end,blue](0,0)(4,3){$u(x)$}[r,red]
\end{tikzpicture}
```

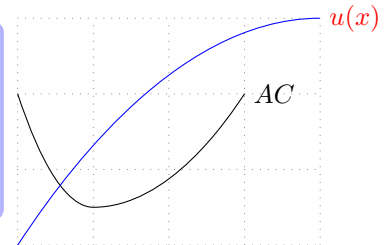

4 An Intuitive Introduction II: Repetition of Coordinates

4.1 Linking many coordinates: Semicolon versions

4.1.1 \tzlines: Connected line segments

`\tzlines` connects with line segments an arbitrary number of coordinates. The coordinate iteration must end with a semicolon `;`. Here, the *semicolon* `';` indicates the *end of repetition* of coordinates. Let us call this kind of macro a *semicolon version* macro.

Remark: `:` Without the semicolon `;`, an error occurs with the the *error message*:

```
! Package tzplot Error: You may have forgotten a semicolon here or above!
```

```
% syntax: minimal
\tzlines[<opt>](<coor>)(<coor>)..repeated..(<coor>);
% syntax: simplified
\tzlines[<opt>]"<path name>"
    (<coor>){<label>}[<angle>]..repeated..(<coor>){<label>}[<angle>];
% defaults
[]""(<m>){}[]..repeated..(){}[];
% <m> means mandatory
```

```
\begin{tikzpicture}
\tzhelplines(4,3)
\tzlines(0,0)(1,2)(3,0)
    (4,1)(2,2)(3,3)
    (0,3)(0,1)(4,2) ; % semicolon
\end{tikzpicture}
```

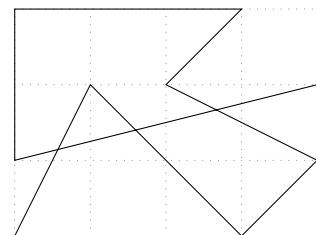

With the optional argument `{<text>}` followed by `[<node opt>]` *in-between two coordinates*, you can print `{<text>}` at or around the middle point of the corresponding line segment in accordance with `[<node opt>]` (by default `[midway]`).

```

\begin{tikzpicture}
\tzhelplines(4,3)
\tzlines[dashed,->](0,0){up}[l]
                    (1,2){down}[r]
                    (3,0){up}[r]
                    (4,1) ; % semicolon
\end{tikzpicture}

```

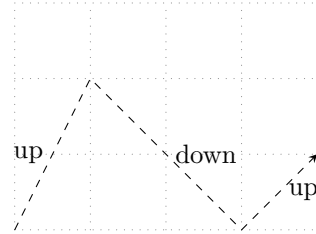

The optional argument `{<text>}` following the last coordinate can be used as a name of the whole connected line segments. The `{<text>}` is placed at (by default) or around the last coordinate according to `[<node opt>]`.

```

\begin{tikzpicture}[sloped,auto]
\tzhelplines(4,3)
\tzlines[dashed,->](0,0){up}
                    (1,2){down}
                    (3,0){up}
                    (4,1){Weight}[r,blue] ; % semicolon
\end{tikzpicture}

```

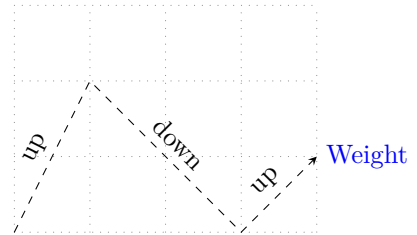

REMEMBER the repeating pattern is the triple `(<coord>){<text>}[<node opt>]` in that order. DO NOT FORGET to indicate when the repetition ends by typing a semicolon. So it will look like `(){}[] ..repeated..(){}[] ;`.

4.1.2 `\tzpolygon`, `\tzpolygon*`: Closed paths

`\tzpolygon` draws closed line segments. `\tzpolygon` is also one of semicolon versions, meaning that it has to end with a semicolon `;`. In fact, `\tzpolygon` is a closed version of `\tzlines`.

The starred version `\tzpolygon*` does the same thing as `\tzpolygon` except for one thing. `\tzpolygon*`, by default, fills the interior of the polygon with `black!50` with `fill opacity=.3` but with `text opacity=1`. (Changing the `fill opacity` is not an issue in this introduction. See Section 16.1.1 on page 115 for more details.)

```

\begin{tikzpicture}
\tzhelplines(4,3)
\tzpolygon(1,3)(0,2)(2,0)(3,1)(4,2)(2,3) ; % semicolon
\end{tikzpicture}

```

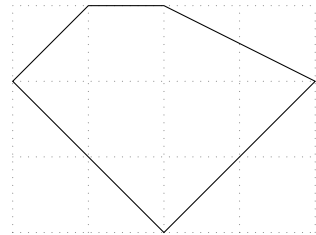

The optional arguments `{<text>}` and `[<node opt>]` *in-between* two coordinates prints `<text>` according to `[<node opt>]` (by default `[midway]`) around the middle point of the corresponding line segment.

```

\begin{tikzpicture}
\tzhelplines(4,3)
\tzpolygon*[green,thick](1,3)(0,2)(2,0)(3,1)(4,2)(2,3) ;
\tzpolygon[dashed]
  (0,0){up}[l] (1,2){down}[r] (3,0){up}[r] (4,1) ;
\end{tikzpicture}

```

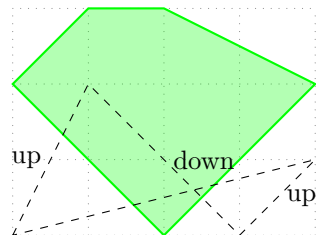

The options `{<text>}` and `[<node opt>]` following the last coordinate can be used as a name of the connected line segments.

The entire repetition will look like `(<coord>){<text>}[<node opt>] ..repeated.. (){}[] ;`. DO NOT FORGET to indicate when the repetition ends by typing a semicolon.

```

\begin{tikzpicture}[sloped,auto]
\tzhelplines(4,3)
\tzpolygon[dashed]
(0,0){up} (1,2){down} (3,0){up} (4,1){Weight}[r] ;
\end{tikzpicture}

```

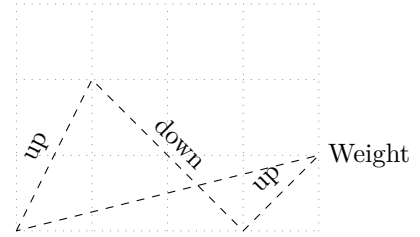

4.1.3 \tzpath*: Filling area

\tzpath accepts an arbitrary number of coordinates to form a path, like \tzlines does, but the path is invisible. This is a *semicolon version* macro, so the coordinate iteration must be ended by a semicolon ;. With [draw] option you can visualize the invisible path.

```

\begin{tikzpicture}
\tzhelplines(4,3)
\tzpath[draw](1,3)(0,2)(2,0)
(3,1)(4,2)(2,3); % semicolon
\end{tikzpicture}

```

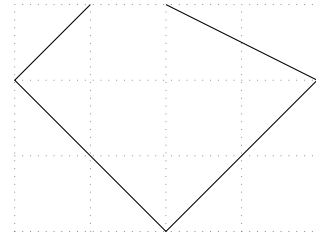

You can fill the interior of a path formed by \tzpath (after being closed) with color or pattern, in usual TikZ way.

```

\begin{tikzpicture}
\tzhelplines(4,3)
\tzline[blue](0,3)(4,0)
\tzpath[pattern=crosshatch]
(1,3)(0,2)(2,0)(3,1)(4,2)(2,3);
\tzpath[pattern=bricks,preaction={fill=brown}]
(0,0)(1,2)(3,0)(4,1);
\end{tikzpicture}

```

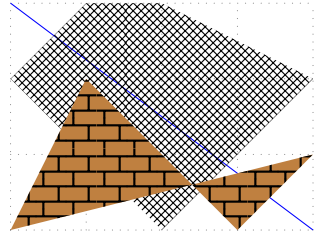

```

\begin{tikzpicture}
\tzhelplines(4,3)
\tzline[blue](0,3)(4,0)
\tzpath[fill,green]
(1,3)(0,2)(2,0)(3,1)(4,2)(2,3);
\tzpath[fill]
(0,0)(1,2)(3,0)(4,1);
\end{tikzpicture}

```

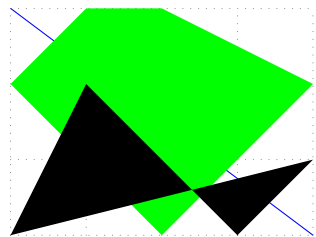

The starred version \tzpath* takes the default options fill=black!50, fill opacity=.3, and text opacity=1 to fill the area.

```

% syntax: simplified
\tzpath* [<opt>] (<coord>){<label>}[<angle>] ..repeated.. (<coord>){<label>}[<angle>];
% defaults
*[fill=black!50,fill opacity=.3,text opacity=1](<m>){}[]..repeated..(){}[];
% <m> means mandatory

```

The macros \tzpath and \tzpath* are much more flexible. See Section 14.1 on page 100 for more details.

```

\begin{tikzpicture}
\tzhelplines(4,3)
\tzline[blue](0,3)(4,0)
\tzpath*[green](1,3)(0,2)(2,0)(3,1)(4,2)(2,3);
\tzpath*(0,0)(1,2)(3,0)(4,1);
\end{tikzpicture}

```

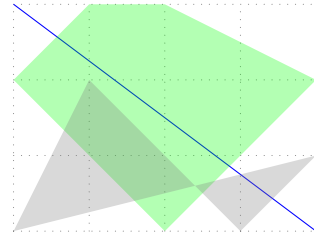

How to change the fill opacity with `\tzpath*` is not discussed in this introduction, but one example is given below. (See Section 14.2 on page 102 for more details.)

```

\begin{tikzpicture}
\tzhelplines(4,3)
\tzline[blue](0,3)(4,0)
\tzpath*[green](1,3)(0,2)(2,0)(3,1)(4,2)(2,3);{1} %%
\tzpath*(0,0)(1,2)(3,0)(4,1);{.7} %%
\end{tikzpicture}

```

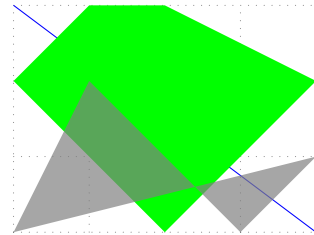

4.2 Many dots: Semicolon versions

4.2.1 `\tzcdots*`

`\tzcdots` accepts an arbitrary number of coordinates to print circle dots, but the coordinate repetition must be ended by `;` (semicolon version). `\tzcdots*` prints filled circle dots.

```

\begin{tikzpicture}
\tzhelplines(4,3)
\tzcdots(0,0)(1,1)(2,1)(3,2)(4,3);
\tzcdots*[red](0,3)(1,3)(2,3)(3,3)(4,2); % semicolon
\end{tikzpicture}

```

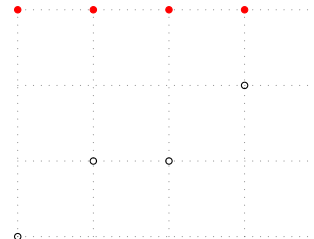

Each coordinate can be labeled by specifying the optional argument `{<label>}` followed by `[<angle>]`. You can also change the size (*radius*) of the dots by specifying the *last* parenthesis option (`<dot radius>`) *after* the semicolon.

```

\begin{tikzpicture}
\tzhelplines(4,3)
\tzcdots(0,0)(1,1){B}(2,1)(3,2){D}[-90](4,3);(5pt)
\tzcdots*[fill=red](0,3){A}
(1,3){B}
(2,3){C}[-90]
(3,3)
(4,2){E}[[blue]0];(3pt) % radius
\end{tikzpicture}

```

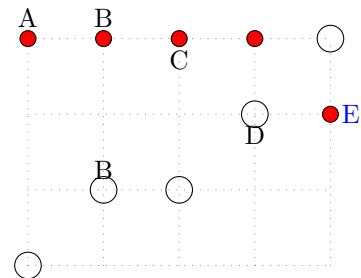

4.2.2 `\tzdots*`

`\tzdots` accepts an arbitrary number of coordinates to print circle node dots, but the repetition must be ended by `;` (semicolon version). `\tzdots*` prints filled circle node dots.

```

% syntax: minimum
\tzdots*(<coor>)(<coor>)..repeated..(<coor>);

```

```

% syntax: simplified
\tzdots* [<opt>] (<coord>){<label>}[<angle>]..repeated..
          (<coord>){<label>}[<angle>]; (<dot size>)

% defaults
*[twdot=2.4pt] (<m>){}[]..repeated..(){}[]; (2.4pt)
% <m> means mandatory

```

```

\begin{tikzpicture}
\tzhelplines(4,3)
\tzdots(0,0)(1,1)(2,1)(3,2)(4,3);
\tzdots*[red](0,3)(1,3)(2,3)(3,3)(4,2); % semicolon
\end{tikzpicture}

```

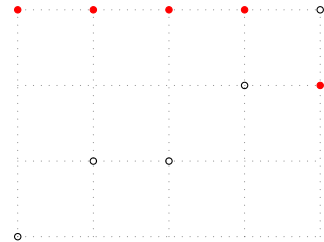

Each coordinate can be labeled by specifying the optional argument `{<label>}` followed by `[<angle>]`. You can also change the size (*diameter*) of the dots by specifying the *last* parenthesis argument `(<dot size>)` after the semicolon.

```

\begin{tikzpicture}
\tzhelplines(4,3)
\tzdots(0,0)(1,1){B}(2,1)(3,2){D}[-90](4,3);(10pt)
\tzdots*[fill=red](0,3){A}
          (1,3){B}
          (2,3){C}[-90]
          (3,3)
          (4,2){E}[[blue]0];(6pt) % diameter
\end{tikzpicture}

```

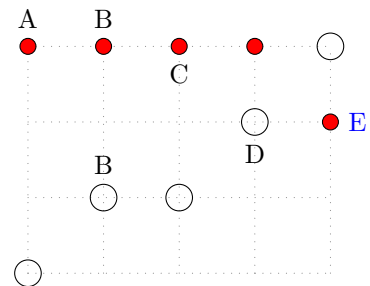

4.3 Many coordinates: Semicolon versions

4.3.1 `\tzcoors`, `\tzcoors*`

`\tzcoor` accepts a pair of mandatory arguments in parentheses: `(<coord>)(<name>)`. The semicolon version macro `\tzcoors` accepts an arbitrary number of pairs to define multiple coordinates. A semicolon ‘;’ is necessary to indicate when the repetition ends.

```

\begin{tikzpicture}
\tzhelplines(4,3)
\tzcoors(0,0)(A)
          (1,1)(B)
          (2,1)(C)
          (3,3)(D)
          (4,2)(E);
\tzlines(A)(B)(C)(D)(E); % semicolon
\end{tikzpicture}

```

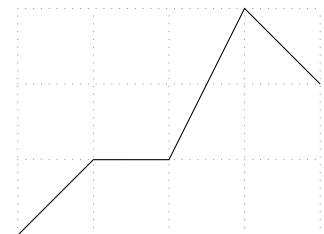

The options `{<label>}` and `[<angle>]` following each pair of `(<coord>)` and `(<name>)` allow you to put `<label>` in the direction of `<angle>` around the coordinate. Here, the repeating pattern is the quadruple `(<coord>)(<name>){<label>}[<angle>]`. The first two parenthesis arguments are mandatory and others are optional. The pattern is repeated until `\tzcoors` meets a semicolon ;.

```

\begin{tikzpicture}
\tzhelpplines(4,3)
\tzcoors(0,0)(A){A}
      (1,1)(B)
      (2,1)(C){C}[0]
      (3,3)(D){D}[180]
      (4,2)(E){E}[-90];
\tzlines(A)(B)(C)(D)(E);
\end{tikzpicture}

```

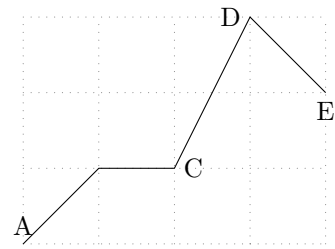

The starred version `\tzcoors*` does one more thing: to print node dots.

```

\begin{tikzpicture}
\tzhelpplines(4,3)
\tzcoors*(0,0)(A){A}
      (1,1)(B)
      (2,1)(C){C}[0]
      (3,3)(D){D}[180]
      (4,2)(E){E}[-90];
\end{tikzpicture}

```

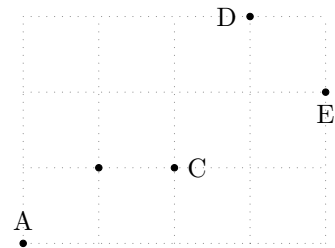

4.3.2 `\tzcoorsquick`

`\tzcoorsquick` is just to see the array of many coordinates at a glance. `\tzcoorsquick` works like `\tzcoors`, but it automatically prints the name of each coordinate as its label, right at the point, by default.

```

\begin{tikzpicture}
\tzhelpplines(4,3)
\tzcoorsquick(0,0)(A)
      (1,1)(Best)
      (2,1)(Case)
      (3,3)(Done)
      (4,2)(End); % semicolon
\end{tikzpicture}

```

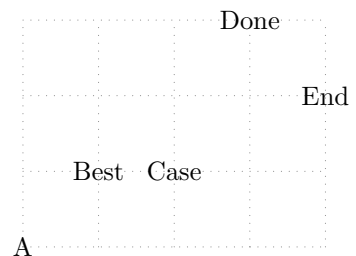

4.3.3 `\tzcoorsquick*`

The starred version `\tzcoorsquick*` prints node dots and automatically puts the labels above (in the direction of 90 degree from) them, by default.

```

\begin{tikzpicture}
\tzhelpplines(4,3)
\tzcoorsquick*(0,0)(A)
      (1,1)(Best)
      (2,1)(Case)
      (3,3)(Done)
      (4,2)(End){END!}[[blue]0];
\end{tikzpicture}

```

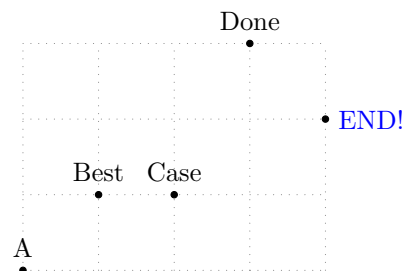

4.4 plot coordinates: Semicolon versions

4.4.1 `\tzplot*`: Mark dots with `[mark=*`]

`\tzplot*` accepts an arbitrary number of coordinates to print bullets with the *radius* (mark size in TikZ) of 2pt, which is the initial value in TikZ. Since this is a semicolon version, the repetition of coordinates must be ended by `;`.

```
\begin{tikzpicture}
\tzhelplines(4,3)
\tzplot*(0,0)
      (1,1)
      (2,1)
      (3,3)
      (4,2) ; % semicolon
\end{tikzpicture}
```

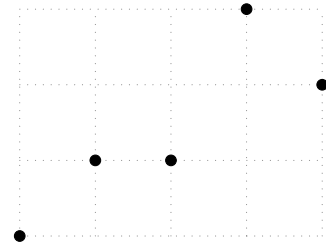

```
\tzplot*(0,0)(1,1)(2,1); % works like:
\draw [mark=*] plot coordinates {(0,0)(1,1)(2,1)};
```

Each coordinate can be labeled by specifying the optional argument `{<text>}` followed by `[<angle>]`. With the option `[mark=o]` you can print hollow dots. You can also change the *radius* of the marks by specifying the *last* parenthesis argument (`<mark size>`) *after* the semicolon.

```
\begin{tikzpicture}
\tzhelplines(4,3)
\tzplot*[mark=o] (0,0){A}
      (1,1){Best}
      (2,1){Case}
      (3,3){Done}
      (4,2){END!}[[blue]0] ; (1.2pt)
\end{tikzpicture}
```

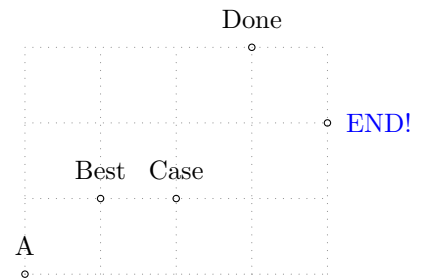

4.4.2 `\tzplot`: Lines with `[tension=0]`

`\tzplot` accepts an arbitrary number of coordinates and draws line segments connecting them. The repetition of coordinates must be ended by `;` (semicolon version).

```
\begin{tikzpicture}
\tzhelplines(4,3)
\tzplot(0,0)
      (1,1)
      (2,1)
      (3,3){Done}
      (4,2){END!}[[blue]0];
\end{tikzpicture}
```

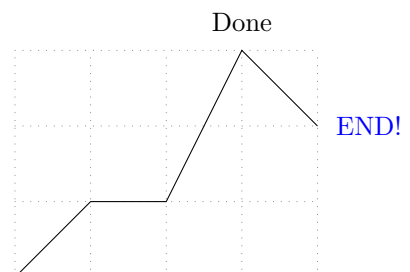

```
\tzplot(0,0)(1,1)(2,1); % works like:
\draw plot coordinates {(0,0)(1,1)(2,1)};
```

4.4.3 `\tzplot*[draw]`: Lines with dots

`\tzplot*[draw]` prints bullet marks at the specified coordinates and draws line segments connecting them. The repetition of coordinates must be ended by `;` (semicolon version).

```
\begin{tikzpicture}
\tzhelplines(4,3)
\tzplot*[draw](0,0)
(1,1)
(2,1)
(3,3)
(4,2){END!}[[blue]0];
\end{tikzpicture}
```

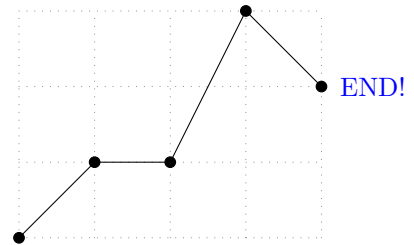

4.4.4 `\tzplotcurve`: Curves with `[smooth,tension=1]`

`\tzplotcurve` plots any number of coordinates with the default option `[smooth,tension=1]`, resulting in a *curve* connecting the specified coordinates. The repetition of coordinates must be ended by `;` (semicolon version).

```
\begin{tikzpicture}
\tzhelplines(4,3)
\tzplotcurve(0,0)
(1,1)
(2,1)
(3,3)
(4,2){END!}[[blue]0] ; % semicolon
\end{tikzpicture}
```

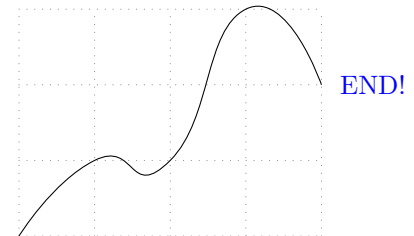

```
% syntax: simplified
\tzplotcurve[<opt>]{<tension>}"<path name>"
    (<coor>){<label>}[<angle>]..repeated..(<coor>){<label>}[<angle>];
% defaults
[smooth,tension=1]{1}"(<m>){}[]..repeated..(){}[];
% <m> means mandatory
```

```
\tzplotcurve(0,0)(1,1)(2,1); % works like:
\draw [smooth,tension=1] plot coordinates {(0,0)(1,1)(2,1)};
```

You can change the tension value by specifying the optional argument `{<tension>}`, before the first coordinate.

```
\begin{tikzpicture}
\tzhelplines(4,3)
\tzcoor(.5,.5)(A)
\tzplotcurve[blue]{2}(1,3)(A)(4,0);
\tzplotcurve[thick](1,3)(A)(4,0); % default: tension=1
\tzplotcurve[red]{.55}(1,3)(A)(4,0); % TikZ default
\tzplotcurve[dashed]{0}(1,3)(A)(4,0);
\end{tikzpicture}
```

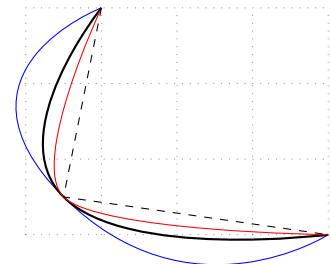

5 An Intuitive Introduction III: Plotting Functions

5.1 Axes

5.1.1 `\tzaxes`

```
% syntax: simplified
\tzaxes[<opt>]<x-shift,y-shift>(<x1,y1>)<x2,y2>
      {<x-text>}[<x-opt>]{<y-text>}[<y-opt>]

% defaults
[->]<0,0>(0,0)<m>{}[right]{}[above]
% <m> means mandatory
```

`\tzaxes` draws the x-axis from `<x1>` to `<x2>` and the y-axis from `<y1>` to `<y2>`.

```
\begin{tikzpicture}[scale=.5]
\tzhelplines(-1,-1)(8,5)
\tzaxes(-1,-1)(8,5) % basics
\end{tikzpicture}
```

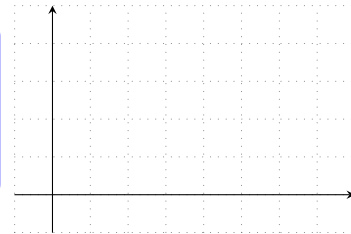

If `(<x1,y1>)` is omitted, it is regarded as `(0,0)`. And optionally the names of x-axis and y-axis can be printed at a specified place (by default, `[right]` for x-axis and `[above]` for y-axis).

```
\begin{tikzpicture}[scale=.5]
\tzhelplines(-1,-1)(8,5)
\tzaxes[draw=blue](8,5){$x$}{$y$} %%
\end{tikzpicture}
```

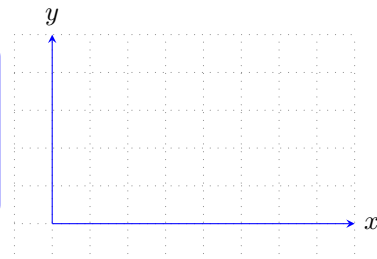

With the optional argument `<x-shift,y-shift>`, the axes are shifted accordingly. Two axes intersect at `(<x-shift,y-shift>)`, by default `(0,0)`.

```
\begin{tikzpicture}[scale=.5]
\tzhelplines(-1,-1)(8,5)
\tzaxes(-1,-1)(8,5){$Q$}[b]{$P$}[l]
\tzaxes[dashed,-]<2,1>(-1,-1)(8,5) % shift
\end{tikzpicture}
```

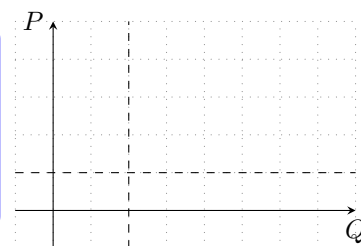

5.1.2 `\tzaxes*`

The starred version `\tzaxes*` is just to set the current state to a *bounding box* when the `\tzaxes` macro execution is completed. Use `\tzaxes*` before any larger graphics.

```

\begin{tikzpicture}[scale=.5]
\tzaxes*(8,5){ $x$ }{ $f(x)$ } % bounding box
\tzhelplines(-2,-1)(10,8)
\tzto[out=90,in=-135,dashed](-2,8)(12,-2)
\tzbezier[blue](-1,-1)(3,-2)(7,12)(10,10)
\end{tikzpicture}

```

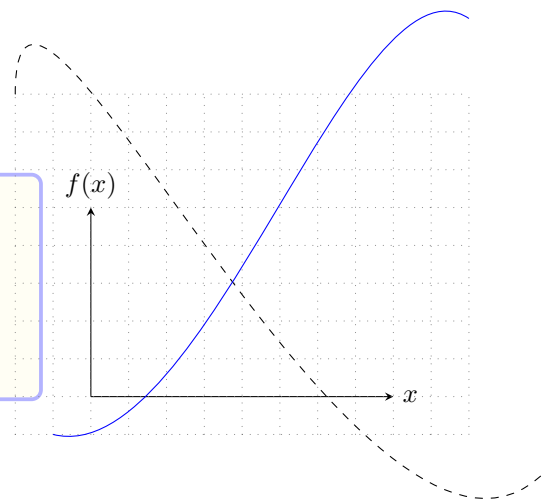

5.1.3 \tzshoworigin, \tzshoworigin*

\tzshoworigin prints '0' (roughly) at the bottom left of the origin.

```

\begin{tikzpicture}[scale=.5]
\tzhelplines(-1,-1)(8,5)
\tzshoworigin
\tzaxes(-1,-1)(8,5)
\end{tikzpicture}

```

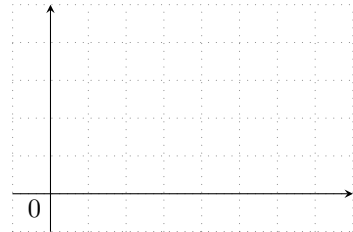

\tzshoworigin* prints a *node dot* with the size of 2.4pt (by default) at the origin.

```

\begin{tikzpicture}[scale=.5]
\tzhelplines(-1,-1)(8,5)
\tzshoworigin*
\tzaxes(-1,-1)(8,5)
\end{tikzpicture}

```

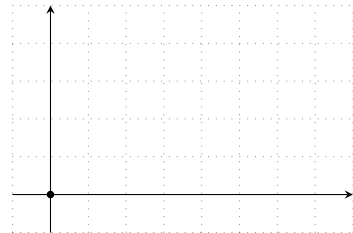

\tzshoworigin*(<coord>){<text>}[<node opt>] prints a node dot and text around (<coord>), by default (0,0). (Notice that the place where the <text> is printed at is not by <angle>. Instead, you can use the *abbreviations* of TikZ basic placement options such as a, l, br, ect. See Section 1.2, for more details.)

```

\begin{tikzpicture}[scale=.5]
\tzhelplines(-1,-1)(8,5)
\tzshoworigin*{ $O_1$ }
\tzaxes(-1,-1)(8,5)
\tzaxes[blue]<7,4>(8,5)(-1,-1)
\tzshoworigin*(7,4){ $O_2$ }[ar]
\end{tikzpicture}

```

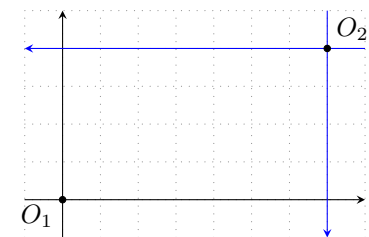

Notice that, in the previous example, the two axes intersect at (7,4) by the shift option <7,4>.

5.1.4 \tzaxisx, \tzaxisy

\tzaxisx draws an x-axis from <x1> to <x2>.

```

% syntax: simplified
\tzaxisx[<opt>]<y-shift>{<x1>}{<x2>}{<text>}[<node opt>]
% defaults
[->, >=stealth] <0>{<m>}{<m>}{ } [right]

```

\tzaxisy works similarly for the y-axis, except for the axis label position: above by default.

```

\begin{tikzpicture}[scale=.5]
\tzhelplines(-1,-1)(8,5)
\tzaxisx{-1}{8}{ $x$ }
\tzaxisy[draw=blue,thick]{-1}{5}{ $y$ }
\tzaxisx[dashed,-]<2>{-1}{8}
\tzaxisy[thick,<->]<1>{-1}{5}
\end{tikzpicture}

```

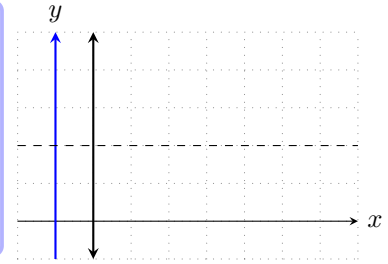

5.2 Ticks

5.2.1 \zticks

`\zticks{<x-tick places>}{<y-tick places>}` prints tick labels for x- and y-axis at specified places, which are comma separated. By default, tick labels are the numbers specified.

```

\begin{tikzpicture}[scale=.5,font=\scriptsize]
\tzhelplines(8,5)
\tzshoworigin
\tzaxes(-1,-1)(8,5)
\tzticks{1,2,...,8} % x-ticks
          {1,2,...,5} % y-ticks
\end{tikzpicture}

```

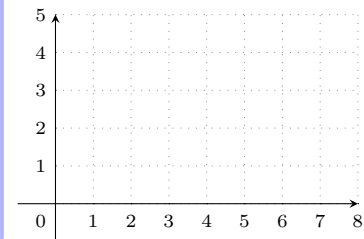

You can change the numbered labels, for example `{2,4,7}`, to any other form, by doing like, for example, `{2/mylabel,4,7}`. (Internally, `\zticks` uses the `foreach` operation of `TikZ`.)

```

\begin{tikzpicture}[scale=.5,font=\scriptsize]
\tzhelplines(8,5)
\tzshoworigin
\tzaxes(-1,-1)(8,5)
\tzticks{2/x,4/y,5.5/ $z_1$ ,7}
          {1,2.5/ $\frac{25}{4}$ ,4}
\end{tikzpicture}

```

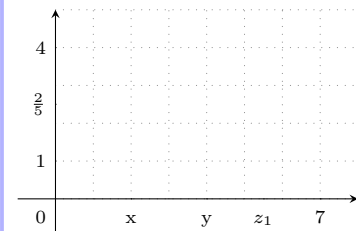

5.2.2 \zticks*

The starred version `\zticks*` prints tick marks from 0pt to 3pt by default, without printing tick labels.

```

\begin{tikzpicture}[scale=.5,font=\scriptsize]
%\tzhelplines(8,5)
\tzshoworigin
\tzaxes(-1,-1)(8,5)
\tzticks*{1,2,...,7}
          {1,2,3,4}
\end{tikzpicture}

```

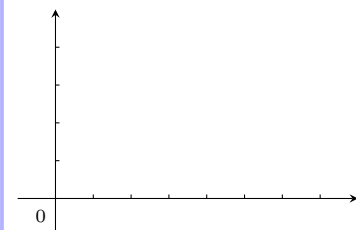

You can change the length of tick marks, for example, like `(-2pt:3pt)` and `(-5pt:10pt)` as shown in the following example.

```

\begin{tikzpicture}[scale=.5]
\tzhelplices(-1,-1)(8,5)
\tzaxes(-1,-1)(8,5)
\ztzticks*(-2pt:3pt){1,2,...,7}
(-5pt:10pt){1,2,3,4}
\end{tikzpicture}

```

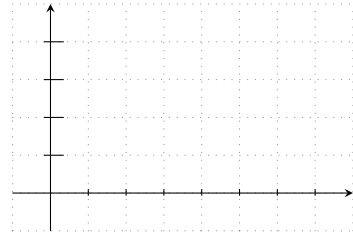

5.2.3 \ztzticksx(*), \ztzticksy(*)

\ztzticksx and \ztzticksy prints x-tick labels and y-tick labels, respectively.

```

\begin{tikzpicture}[scale=.5,font=\scriptsize]
\tzhelplices(8,5)
\tzaxes(-1,-1)(8,5)
\ztzticksx{1/x,3/y,5/z,7}
\ztzticksy(-5pt:10pt){1,2,4/k}
\end{tikzpicture}

```

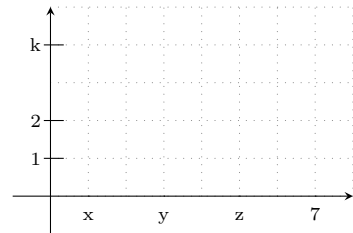

\ztzticksx* and \ztzticksy* suppress tick labels for their corresponding axes, like \ztzticks*.

```

\begin{tikzpicture}[scale=.5,font=\scriptsize]
%\tzhelplices(8,5)
\tzaxes(-1,-1)(8,5)
\ztzticksx*{1/x,3/y,5/z,7}
\ztzticksy*(-5pt:10pt){1,2,4/k}
\end{tikzpicture}

```

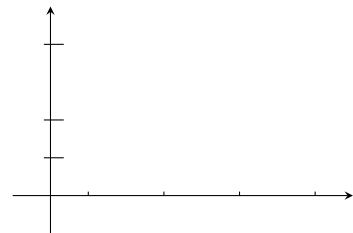

You can see more details on \ztzticks and its friends in Chaper 19 on page 145.

5.3 Projections on the axes

5.3.1 \tzprojx(*), \tzprojy(*)

\tzprojx draws a *dotted line* (by default) from a specified coordinate to its projection point on the x-axis and prints text around ([below] by default) the projection point.

\tzprojy works similarly but for the projection point on the y-axis.

```

\begin{tikzpicture}
\tzhelplices(4,3)
\tzaxes(4,3)
\tzdot*(3,2){$(x_1,x_2)$}[45]
\tzprojx(3,2){$x_1$}
\tzprojy[solid,->,draw=blue](3,2){$x_2$}[bl]
\end{tikzpicture}

```

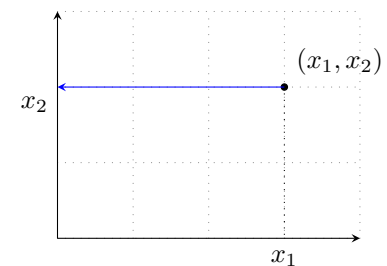

\tzprojx* does one more thing. It prints a node dot (with \tzdot*) at a specified coordinate. \tzprojy* works similarly but for the projection point on the y-axis.

```

\begin{tikzpicture}
  \tzhelpplines(4,3)
  \tzaxes(4,3)
  \tznode(3,2){$(x_1,x_2)$}[ar]
  \tzprojx*(3,2){$x_1$}[xshift=-3pt]
  \tzprojy[->,dashed,draw=red](3,2){$x_2$}
  \tzprojx*(1.5,2.5){$a$}
  \tzprojy*(2.5,1.5){$b$}
\end{tikzpicture}

```

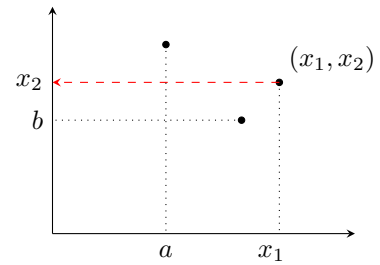

5.3.2 \tzproj(*)

\tzproj combines \tzprojx and \tzprojy. And \tzproj* combines \tzprojx* and \tzprojy*.

```

\begin{tikzpicture}
  \tzhelpplines(4,3)
  \tzaxes(4,3)
  \tznode(3,2){$(x_1,x_2)$}[ar]
  \tzproj[<->,solid,draw=red](3,2){$x_1$}{$x_2$}
  \tzproj*(1.5,2.5){$a$}[xshift=3pt,text=blue]{$b$}
\end{tikzpicture}

```

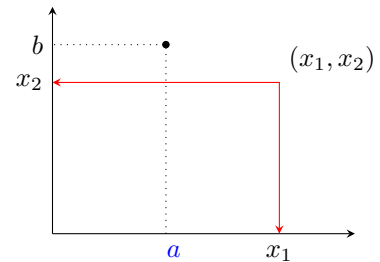

5.4 Plot functions

5.4.1 \tzfn

\tzfn{<fn of \x>}[<a:b>] plots a function of x over the specified domain $[a : b]$, which means that $a \leq x \leq b$. Optionally, you can add {<text>} with [<node opt>] as shown in the following example.

```

% syntax: simplified
\tzfn[<opt>]"<path name>"{<fn of \x>}[<a:b>]{<text>}[<node dot>]
% defaults
[]""{<m>}[<m>]{[]}
% <m>: mandatory

```

```

\begin{tikzpicture}[scale=.7]
  \tzhelpplines(5,5)
  \tzaxes(5,5)
  \tzfn{(\x-1)^2}[0:3] % y=(x-1)^2
  \def\Gx{(\x-2)^2+1}
  \tzfn[dashed]{\Gx}[1:4]{$g(x)$}[r] % g(x)=(x-2)^2+1
  \tzfn[red]{sin(\x r)+3}[0:2*pi] % y=sin x
\end{tikzpicture}

```

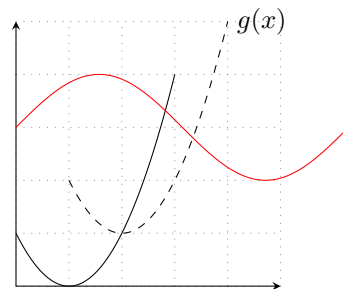

```

\tzfn[dashed]{(\x-2)^2+1}[1:4]{$g(x)$}[r] % works like:
\draw [dashed] plot [domain=1:4] (\x,{(\x-2)^2+1}) node [right] {$g(x)$};

```

You can name a path formed by \tzfn by specifying the optional argument "<path name>" right before the mandatory curly brace argument {<fn of \x>}. The name of a path is used to find intersection points.

```

\begin{tikzpicture}[scale=.7,font=\footnotesize]
\tzhelplines(5,5)
\tzaxes(5,5){$x$}{$y$}
\def\bgt{4-\x}
\def\IC{3/\x}
\def\ICa{4/\x}
\tzfn"bgt"{\bgt}[0:4] % name path = bgt
\tzfn[blue]"IC"{\IC}[.75:4] % name path = IC
\tzfn[red]{\ICa}[1:4] % name path = ICa (automatically)
\end{tikzpicture}

```

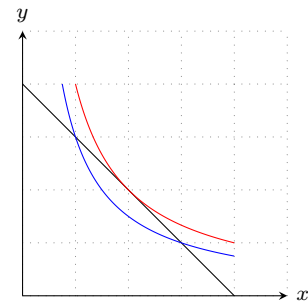

Remark: If the curly brace mandatory argument consists of *only a macro name* like `{\Foo}`, the macro name `Foo` (without the backslash) is automatically assigned to the *name of the path*. (See Section 21.1.4 on page 155, for more details.)

5.4.2 `\tzhfnat`, `\tzhfn`: Horizontal lines

`\tzhfnat` accepts a value of y and draws a horizontal line (the graph of a constant function) at y from left to right of the current bounding box, by default, unless you specify the optional argument [`<from:to>`].

```

% syntax
\tzhfnat [<opt>]"<path name>"{<y-val>}[<from:to>]{<text>}[<node opt>]
% defaults
[]""{<m>}[west:east (of current bounding box)]{}[]

```

`\tzhfn(<coord>)` accepts a coordinate, instead of the value of y , to draw a horizontal line at the value of y coordinate of (`<coord>`), ignoring the value of x coordinate.

```

\begin{tikzpicture}
\tzhelplines(4,3)
\tzhfnat{0} % value of y
\tzhfnat[dashed]{1}[1:4]{Two}[1,at start] % value of y
\tzcoors(0,2)(A)(0,3)(B);
\tzhfn[blue](A)[0:3]{Three}[b,near end] % coordinate
\tzhfn[->](B)[0:3]{Four}[r] % coordinate
\end{tikzpicture}

```

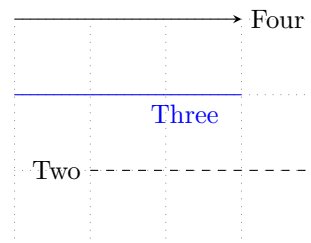

5.4.3 `\tzvfnat`, `\tzvfn`: Vertical lines

`\tzvfnat` draws a vertical line at x from bottom to top of the current bounding box by default.

```

% syntax: simplified
\tzvfnat [<opt>]"<path name>"{<x-val>}[<from:to>]{<text>}[<pos>]
% defaults
[]""{<m>}[south:north (of current bounding box)]{}[]

```

`\tzvfn(<coord>)` accepts a coordinate, instead of the value of x . It draws a vertical line at the value of x coordinate of (`<coord>`), ignoring the value of y coordinate.

```

\begin{tikzpicture}
\tzhelplines(4,3)
\tzvfmat{0}
\tzvfmat[dashed]{1}[1:3]{Two}[b,at start]
\tzvfmat[blue]{2,0}[0:3]{Three}[a,near end,sloped]
\tzvfmat[->]{3,0}[0:3]{Four}[r]
\end{tikzpicture}

```

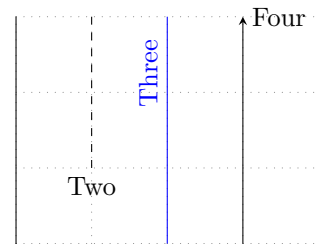

5.4.4 \tzLFn: Linear functions

\tzLFn(<coor1>)(<coor2>)... draws a *linear function* passing through two points: (<coor1>) and (<coor2>). \tzLFn(<coor1>){<slope>}... draws a linear function passing through one point, (<coor1>), with the slope of <slope>. If two coordinates and a slope are all specified the option {<slope>} is ignored. The domain in the form of [a:b] is also a required argument.

```

\begin{tikzpicture}[scale=.7,font=\footnotesize]
\tzhelplines(5,5)
\tzaxes(-1,-1)(5,5)
\tzdots*(1,1)(3,2);
\tzLFn(1,1)(3,2)[0:4]{two points}[r]
\tzLFn(1,1){1.5}[0:3]{one point and a slope}[r]
\end{tikzpicture}

```

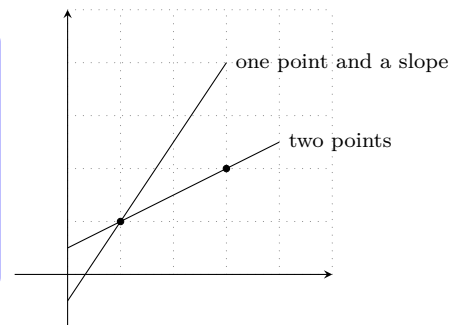

5.5 Intersection points

5.5.1 Naming paths

In TikZ, you can find *intersection* points when two *named paths* intersect. The name of a path is usually given by the option [name path=<path name>] in TikZ.

With the package tzplot, you can name a path by specifying an optional argument within quotation marks such as "<path name>". (Of course, you can also name a path in usual TikZ way, like [name path=<path name>].)

In this package, all macros (with a few exceptions) related to lines and curves accept this quote optional argument to name paths as follows:

```

\tzline[<opt>]"<path name>"(<coor>)...
\tzlines... "<path name>"(<coor>)...
\tzto... "<path name>"(<coor>)...
\tzfn... "<path name>"{<fn of \x>}...
\tzLFn... "<path name>"(<coor>)...
and more...

```

```

\tzline[dashed]"foo"(1,1)(3,3) % works like
\draw [dashed,name path=foo](1,1) -- (3,3);

```

In most cases, the quote optional arguments for naming paths are placed *immediately before the first mandatory argument* of the tzplot macros.

5.5.2 \tzXpoint(*): Intersection points of two paths

For example, \tzXpoint{path1}{path2}(A) finds intersection points of path1 and path2 and names the first intersection point (A). This intersection point can be referred to as (A) or (A-1).

If there are two or more intersection points found, they are called (A)=(A-1), (A-2), (A-3), and so on.

```
\begin{tikzpicture}
\tzhelplines(4,3)
\tzline"AA"(0,0)(3,2)
\tzline"BB"(0,3)(3,0)
\tzXpoint{AA}{BB}(X)
\tzdot*(X){E}
\end{tikzpicture}
```

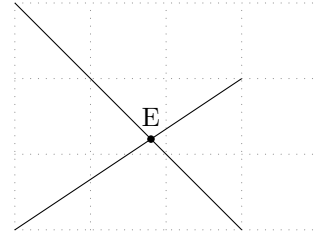

`\tzXpoint*` prints a node dot at the first intersection point. You can label the point by specifying `<text>` and `[<angle>]` after the specified intersection name.

```
\begin{tikzpicture}[scale=.7,font=\footnotesize]
\tzhelplines(5,5)
\tzaxes(5,5){$x$}{$y$}
\def\bgt{4-\x}
\def\IC{3/\x}
\tzfn"bgt"{\bgt}[0:4] % name path = bgt
\tzfn[blue]"IC"{\IC}[.75:4] % name path = IC
\tzXpoint*{bgt}{IC}(E){$A$}[45] % first intersection
\tzdot(E-2){$B$}[45](5pt) % second intersection
\end{tikzpicture}
```

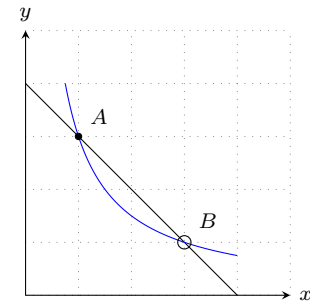

Remark: You have to expect TikZ to take a few seconds (or less) to find intersection points.

5.5.3 `\tzvXpointat(*)`, `\tzvXpoint(*)`: Vertical intersection points

To find vertical intersection points at x to a curve, you should specify a path name and either the value of x or the coordinate (x, y) . Here the y coordinate is ignored.

`\tzvXpointat{<path>{<x>}}(A)` finds vertical intersection points of `<path>` at $x = <x>$ and names it (A). The starred version `\tzvXpointat*` additionally prints a node dot at the (first) intersection point.

The macro `\tzvXpoint` uses `<coor>`, while `\tzvXpointat` uses the value of x . Here the y coordinate of `<coor>` is not important. `\tzvXpoint` is useful when you do not know the exact value of x coordinate of `<coor>`. The starred version `\tzvXpoint*` additionally prints a node dot at the (first) intersection point.

```
\begin{tikzpicture}[scale=.7,font=\scriptsize]
\tzhelplines(5,5)
\tzaxes(5,5)
\def\Fx{(\x-1)^2}
\tzfn\Fx[0:3] % name path = Fx (automatically)
\tzvXpointat{Fx}{2.5}(A)
\tzvXpoint{Fx}(2.8,1)(B) % y=1 is ignored
\tzproj*[->](A){$2.5$}{$f(2.5)$}
\tzdot(B){$B$}[0]
\end{tikzpicture}
```

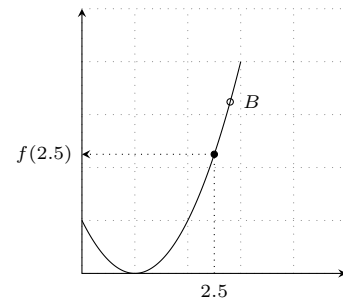

5.5.4 `\tzhXpointat(*)`, `\tzhXpoint(*)`: Horizontal intersection points

`\tzhXpointat{<path>{<y>}}(A)` works like `\tzvXpointat{<path>{<x>}}(A)`, but it uses the value of y instead of x . The starred version `\tzhXpointat*` additionally prints a node dot at the (first) intersection point.

`\tzhXpoint` uses `(<coor>)`, while `\tzhXpointat` uses the value of y . Here the x coordinate of `(<coor>)` is ignored. The starred version `\tzhXpoint*` prints a node dot at the (first) intersection point.

```
\begin{tikzpicture}[scale=.7,font=\scriptsize]
\tzhelplines(5,5)
\tzaxes(5,5)
\def\Fx{(\x-1)^2}
\tzfn\Fx[0:3] % name path = Fx (automatically)
\tzhXpointat{Fx}{2.5}(A)
\tzhXpoint{Fx}(1,2.8)(B) % x=1 is ignored
\tzproj*[-](A){$f^{-1}$}(2.5){$y=2.5$}
\tzdot(B){$B$}[0]
\end{tikzpicture}
```

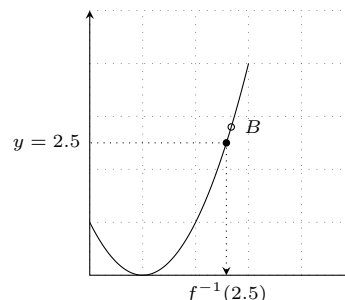

You can see more details on `\tzXpoint` and its friends in Chapter 24 on page 171.

5.6 Tangent lines and secant lines

5.6.1 `\tztangentat`

`\tztangentat{<path>}{<x>}[<a:b>]` draws a tangent line to `<path>` at $x = <x>$ over $x \in [a, b]$. The domain is a mandatory argument and should be of the form `[<from:to>]`.

```
% syntax: simplified
\tztangentat{<path>}{<x>}[<domain>]{<text>}[<node opt>]
% defaults
[] {<m>} {<m>} {<m>} {} []
% <m> means mandatory
```

Remark: The slope of a tangent line drawn by `\tztangentat` is just approximate.

The line is drawn on the **behind** layer, by default.

You can also add some text next to the tangent line by specifying the optional arguments `{<text>}` and `[<node opt>]`, after the domain.

```
\begin{tikzpicture}[scale=.7]
\tzhelplines(5,5)
\tzparabola[thick,blue]"curve"(0,1)(2,3)(4,2)
\tzvXpointat*{curve}{1}
\tzvXpointat*{curve}{3}
\tztangentat{curve}{1}[0:3]
\tztangentat[red]{curve}{3}[1:5]{tangent at $x=3$}[b]
\end{tikzpicture}
```

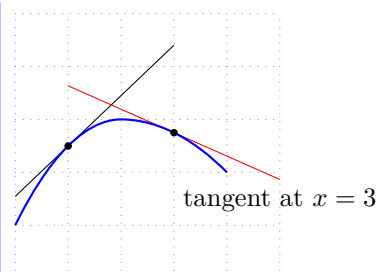

5.6.2 `\tztangent`

`\tztangent` works like `\tztangentat`, but it accepts a coordinate instead of the value of x .

`\tztangent{<path>}(<coor>)` draws a tangent line to `<path>` at the x coordinate of `(<coor>)`. Here, the y coordinate of `(<coor>)` is ignored. The line is drawn on the **behind** layer, by default.

```
% syntax: simplified
\tztangent{<path>}( <coor>)[<from:to>]{<text>}[<node opt>]
% defaults
[] {<m>} (<m>) [<m>] {} []
```

```

\begin{tikzpicture}[scale=.7]
\tzhelplices(5,5)
\tzparabola[thick,blue]"curve"(0,1)(2,3)(4,2)
\tzvXpoint*{curve}(1,0)(A){A}[135]
\tzvXpoint*{curve}(3,0)(B){B}[45]
\ztangent{curve}(A)[0:3]
\ztangent[red]{curve}(B)[1:5]{tangent at $$$}[b]
\end{tikzpicture}

```

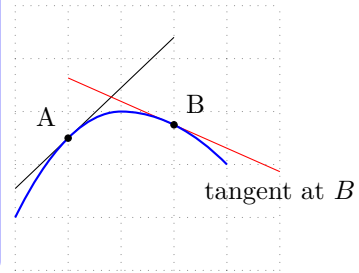

See Section 25.2 on page 179 for more details on `\ztangent` and `\ztangentat`.

5.6.3 `\tzsecantat`, `\tzsecant`

`\tzsecantat{<path>}{<x1>}{<x2>}` draws a secant line segment of `<path>` from $x_1 = <x1>$ to $x_2 = <x2>$ on the behind layer, by default.

```

\begin{tikzpicture}[scale=.7]
\tzhelplices(5,5)
\tzaxes*(5,5)
\tzparabola"curve"(0,1)(2,3)(5,1)
\tzsecantat{curve}{1}{2}
\tzsecantat[red]{curve}{1}{3}
\tzsecantat[blue]{curve}{1}{4}
\end{tikzpicture}

```

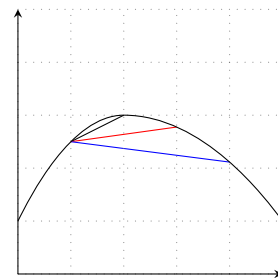

`\tzsecant` works like `\tzsecantat`, but it accepts two coordinates instead of two values of x .

`\tzsecant{<path>}(<coor1>) (<coor2>)` draws a secant line segment of `<path>` from the x coordinate of `(<coor1>)` to the x coordinate of `(<coor2>)`, ignoring y values of the coordinates, on the behind layer by default.

```

\begin{tikzpicture}[scale=.7]
\tzhelplices(5,5)
\tzaxes(5,5)
\tzparabola"curve"(0,1)(2,3)(5,1)
\tzsecant{curve}(1,0)(2,0)
\tzsecant[red]{curve}(1,0)(3,0)
\tzsecant[blue,dashed]{curve}(1,0)(4,0)
\end{tikzpicture}

```

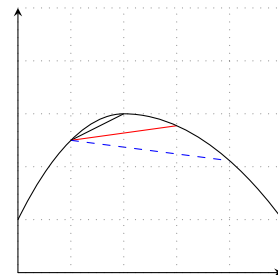

You can extend or shorten a secant line by specifying the domain `[<from>:<to>]`, which is an optional argument. If you specify the domain, `\tzsecant` draws a secant line over the domain. You can also add some text next to the secant line by specifying the optional arguments `{<text>}` and `[<node opt>]`.

```

\begin{tikzpicture}[scale=.7]
\tzhelplices[use as bounding box](5,5)
\tzaxes(5,5)
\tzparabola"curve"(0,1)(2,3)(5,1)
\tzsecant{curve}(1,0)(2,0)
\tzsecant[red]{curve}(1,0)(3,0)[0:5]{secant}[r]
\tzsecantat[blue,dashed]{curve}{1}{4}[0:5]{blue}[r]
\end{tikzpicture}

```

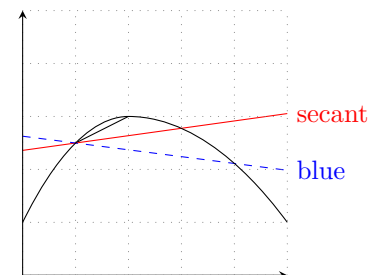

See Section 25.1 on page 176 for more details on `\tzsecant` and `\tzsecantat`.

6 Examples: Economics

6.1 Markets

6.1.1 Market equilibrium: step by step

Step 1 Determine the size of the graph.

```
\begin{tikzpicture}[x=0.05cm,y=0.05cm,scale=.7]
% to avoid 'dimension too large' error: x/y=0.05cm
\tzhelplines[step=.5cm](110,110)
\tzaxes(110,110){$Q$}{$P$}
%\tzto[bend right=15]"dem"(0,100)(100,0){$D$}[a]
%\tzto[bend right=15]"supp"(0,10)(100,90){$S$}[ar]
%\tzXpoint*{dem}{supp}(eqm){$E$}
%\tzproj(eqm){$Q^*$}{$P^*$}
\end{tikzpicture}
```

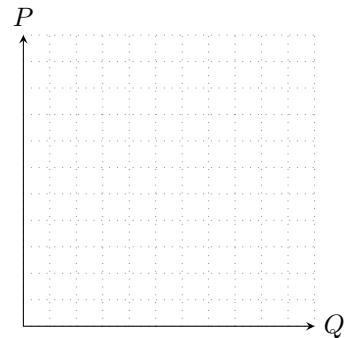

Step 2 Draw the demand and supply curves. Here, we are using `\tzto`.

```
\begin{tikzpicture}[x=0.05cm,y=0.05cm,scale=.7]
% to avoid 'dimension too large' error: x/y=0.05cm
\tzhelplines[step=.5cm](110,110)
\tzaxes(110,110){$Q$}{$P$}
\tzto[bend right=15]"dem"(0,100)(100,0){$D$}[a]
\tzto[bend right=15]"supp"(0,10)(100,90){$S$}[ar]
%\tzXpoint*{dem}{supp}(eqm){$E$}
%\tzproj(eqm){$Q^*$}{$P^*$}
\end{tikzpicture}
```

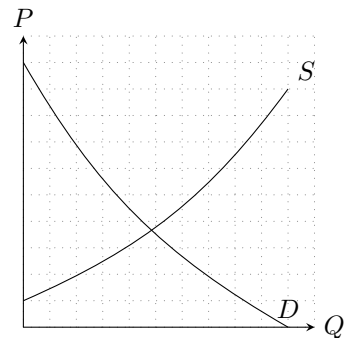

Step 3 Find an equilibrium point and name it. Use the starred version `\tzXpoint*` to print a dot and then label the point.

```
\begin{tikzpicture}[x=0.05cm,y=0.05cm,scale=.7]
% to avoid 'dimension too large' error: x/y=0.05cm
\tzhelplines[step=.5cm](110,110)
\tzaxes(110,110){$Q$}{$P$}
\tzto[bend right=15]"dem"(0,100)(100,0){$D$}[a]
\tzto[bend right=15]"supp"(0,10)(100,90){$S$}[ar]
\tzXpoint*{dem}{supp}(eqm){$E$}
%\tzproj(eqm){$Q^*$}{$P^*$}
\end{tikzpicture}
```

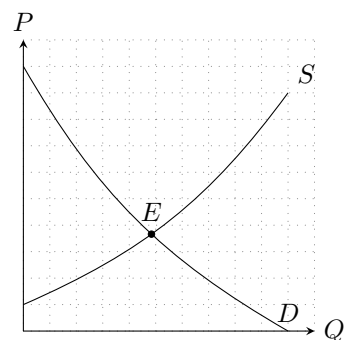

Step 4 If necessary, use `\tzproj` to draw projection lines with text around the projection points.

```
\begin{tikzpicture}[x=0.05cm,y=0.05cm,scale=.7]
% to avoid 'dimension too large' error: x/y=0.05cm
%\tzhelplines[step=.5cm](110,110)
\tzaxes(110,110){$Q$}{$P$}
\tzto[bend right=15]"dem"(0,100)(100,0){$D$}[a]
\tzto[bend right=15]"supp"(0,10)(100,90){$S$}[ar]
\tzXpoint*{dem}{supp}(eqm){$E$}
\tzproj(eqm){$Q^*$}{$P^*$}
\end{tikzpicture}
```

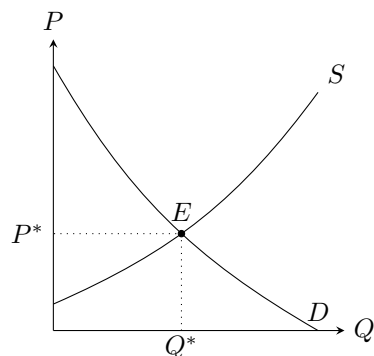

6.1.2 Tax incidence: step by step

Step 1: Determine the size of the graph.

```
\begin{tikzpicture}[scale=.035,font=\scriptsize]
\tzhelplines[step=10cm](120,120)
\tzaxes(120,120){$Q$}{$P$}
\end{tikzpicture}
```

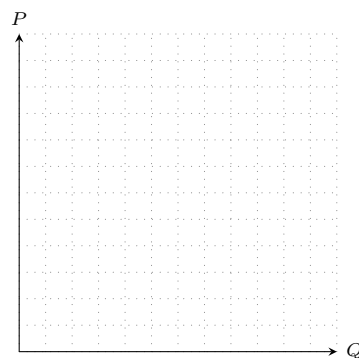

```
\begin{tikzpicture}[scale=.035,font=\scriptsize]
%\tzhelplines[step=10cm](120,120)
\tzaxes(120,120){$Q$}{$P$}
% step 2
\def\demA{100-\x}
\def\suppA{10+\x}
\tzfn\demA[0:100]{$D$}[ar] % name path = \demA
\tzfn\suppA[0:90]{$S$}[r] % name path = \suppA
\tzXpoint*{demA}{suppA}(E){$E$}
% step 3
\tzfn[dashed]"suppB"{\suppA+20}[0:80]{$S'$}[ar]
\tzXpoint*{demA}{suppB}(newE){$E'$}
\tzproj(newE){$Q$}{$P_d$}
% step 4
\tzvXpoint{suppA}(newE)(vX)
% step 5
\tzprojy(vX){$P_s$}
\tzprojy(E){$P^c$}
% step 6
\tzpath*[red](E)(newE)(vX);
% step 7
\tznode($E$!10cm!(E-|0,0)$){}[pin={-70:SWL}]
\end{tikzpicture}
```

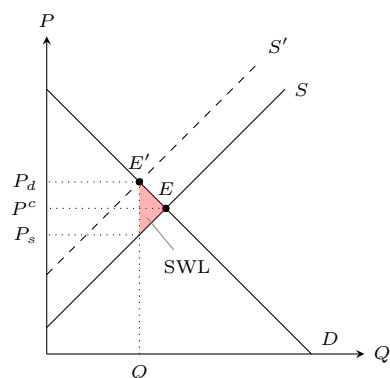

Step 2: Define functions and plot them. And then, find an intersection point.

Step 3: Draw the shifted supply curve and find new equilibrium point. And then, project the point on each axis.

- Step 4: To illustrate the social welfare loss (SWL), find a vertical intersection point of the original supply curve using new equilibrium point.
- Step 5: Project both of the old equilibrium point and the vertical intersection point onto the y axis and add text.
- Step 6: Fill the area of the social welfare loss with color.
- Step 7: Add text 'SWL' at the appropriate place.

6.2 Firms

6.2.1 Cost curves

```

\begin{tikzpicture}[scale=.4,font=\scriptsize]
\tzhelplines(10,10)
\tzaxes(10,10){$q$}{$AC$\\$AVC$\\$MC$}[align=center]
\tzparabola"MC"(.5,4)(2,2)(6,9){$MC$}[a]
\tzhXpointat{MC}{5}(A)
\tzhXpointat{MC}{3}(B) % (B-2) will be used!
\tzdots*(A)(B-2);
\tzparabola(2,7)(A)(8,9){$AC$}[r]
\tzparabola(1,4.5)(B-2)(8,8){$AVC$}[r]
\end{tikzpicture}

```

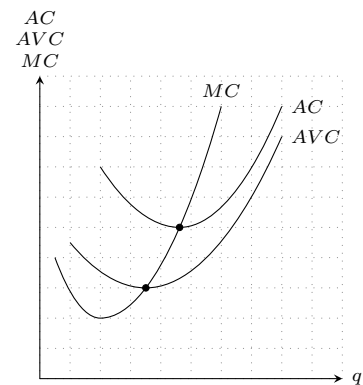

6.2.2 Equilibrium of a competitive firm

```

\begin{tikzpicture}[scale=.4,font=\scriptsize]
%\tzhelplines(10,10)
\tzaxes(10,10){$q$}{$P$\\$AC$\\$MC$}[align=center]
\tzparabola"MC"(2,2)(6,9){$MC$}[a]
\tzhXpointat{MC}{4}(A) % point (A) on MC at q=4
\tzparabola"AC"(2,7)(A)(8,9){$AC$}[r] % (A): minAC
\tzhfnat[blue]"price"{6}[0:9]{$P$}[1,at start]
\tzXpoint*{price}{MC}(E)
\tzprojx(E){$q^*$}
\tzvXpoint{AC}(E)(ACeqm) % point on AC in equilibrium
\tzprojy(ACeqm){$AC(q^*$)}
\tzpath*[red](E-|0,0)(E)(ACeqm)(ACeqm-|0,0);
\tznnode(2,5){$\pi^*$}
\end{tikzpicture}

```

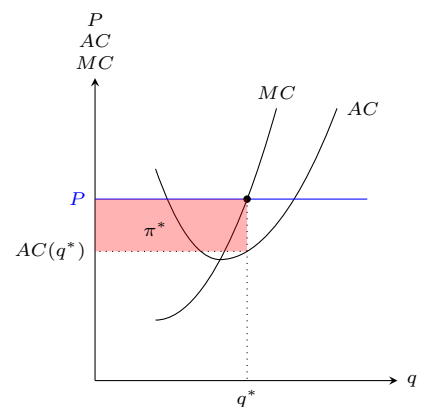

6.2.3 Monopoly equilibrium

```

\begin{tikzpicture}[scale=.5,font=\scriptsize]
%\tzhelplines(10,10)
\tzaxes(10,10){$Q$}{$P$}
\def\DD{8-\x}
\def\MR{8-2*\x}
\def\MC{\x}
\tzfn\DD[0:8]{$D$}[ar]
\tzfn\MR[0:4.5]{$MR$}[r]
\tzfn\MC[0:7]{$MC$}[r]
\tzXpoint*\MR-\MC(E)
\tzvXpoint*\DD(E)(EE)
\tzproj(EE){$Q^M$}{$P^M$}
\tzXpoint\DD-\MC(C)
\tzpath*(EE)(C)(E);
\tznnode(C){\tiny SWL}[1]
\tzpath*[blue](0,8)(EE)(E-|0,0);
\tznnode(1,6){C.S.}
\tzpath[pattern=horizontal lines](0,0)(E)(E-|0,0);
\tznnode(1,2){P.S.}
\end{tikzpicture}

```

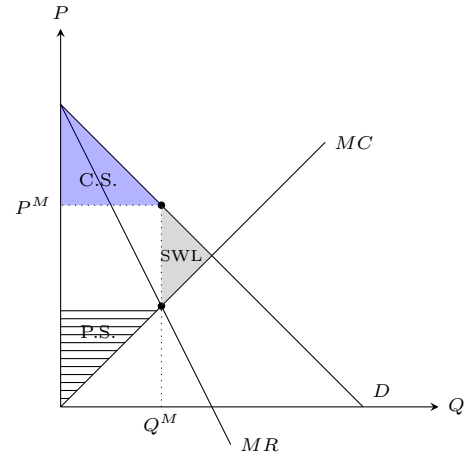

6.3 Consumers: Budget lines and indifference curves

```

\begin{tikzpicture}[scale=.3,font=\scriptsize]
%\tzhelplines(15,12)
\tzaxes(15,12){$x$}{$y$}
\def\bgt{-3/4*\x+9} % 3x+4y=36
\tzfn\bgt[0:12]
\tzvXpoint*\bgt(6,0)(A){A}[45]
\tzplotcurve"ICC"(3,9)(A)(12,3); % trial and error
\tzproj(A){$x^*$}{$y^*$}
\tzticks{12}{9}
\end{tikzpicture}

```

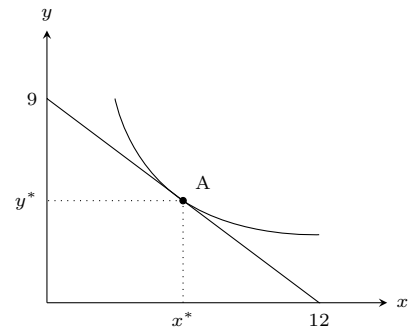

```

\begin{tikzpicture}[scale=.15,font=\scriptsize]
%\tzhelplines(35,25)
\tzaxes(35,25){$x$}{$y$}
\def\bgt{-2/3*\x+20} % 2x+3y=60
\def\IC{150/\x} % u(x,y)=xy
\tzfn\bgt[0:30]
\tzfn\IC[7:30]
\tzcoor*(15,10)(E){$E$}[45]
\tzproj(E)
\tzticks{15,30}{10,20}
\tzvXpointat*[red]{\IC}{12}(A)
\tztangent[blue,densely dashed]{\IC}(A)[5:20]
\end{tikzpicture}

```

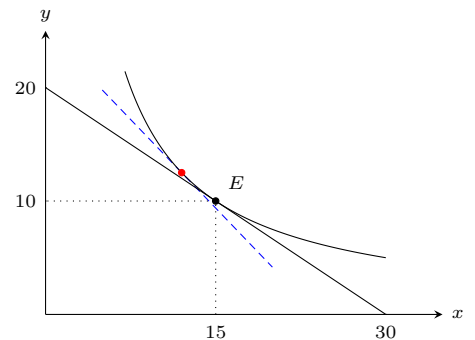

6.4 Production Possibility Curves

```

\begin{tikzpicture}[scale=.5,font=\scriptsize]
\tzhelplines(9,8)
\tzaxes(9,8){$X$}{$Y$}
\tzto[out=-10,in=105]"PPC"(0,7)(6,0){PPC}[ar]
\tzvXpointat*{PPC}{2}(E)
\tztangent[blue]"tan"{PPC}(E)[0:8]
\tzvXpointat*{tan}{4}(F)
\tzplotcurve[densely dashed,red](2,7)(F)(8,4);
\end{tikzpicture}

```

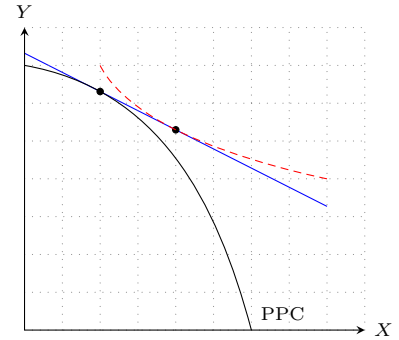

6.5 Edgeworth box

```

\begin{tikzpicture}[scale=.5,font=\scriptsize]
%\tzhelplines(9,7)
\tzaxes(9,7){$x_1$}{$y_1$}
\tzaxes<8,6>(8,6)(-1,-1){$x_2$}[1]{$y_2$}[b]
\tzshoworigin{$O_1$}
\tzshoworigin(8,6){$O_2$}[ar]
\tzto[bend right](2,5)(7,2){$u_1$}[r]
\tzto[bend left](1,4)(6,1){$u_2$}[b]
\end{tikzpicture}

```

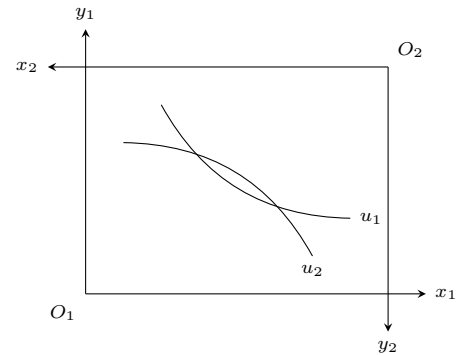

6.6 Growth

```

\begin{tikzpicture}[scale=.5,font=\scriptsize]
%\tzhelplines(10,8)
\tzshoworigin
\tzaxes*(10,8){$k$}{$y$} % bounding box
\def\Fk{3*(\x)^(1/3)}
\def\sFk{2*(\x)^(1/3)}
\def\ndk{7/9*\x}
\tzfn\Fk[0:9]{$y=f(k)$}[r] % name path=Fk
\tzfn\sFk[0:9]{$sf(k)$}[r] % name path=sFk
\tzfn\ndk[0:9]{$(n+\delta)k$}[r] % name path=ndk
\tzXpoint*{sFk}{ndk}(E)[2]{$E$}[135] % (E)=(E-2)
\tzvXpoint*{Fk}(E)(YE) % 2nd X point
\tzproj(YE){$k^*$}{$y^*$}
\tzvXpointat*{Fk}{2}(A)
\tzvXpointat*{sFk}{2}(B)
\tzvXpointat*{ndk}{2}(C)
\tzproj(A){$k_0$}{$y_0$}
\tzprojy(B){$sf(k_0)$}
\tzprojy(C){$(n+\delta)k_0$}
\end{tikzpicture}

```

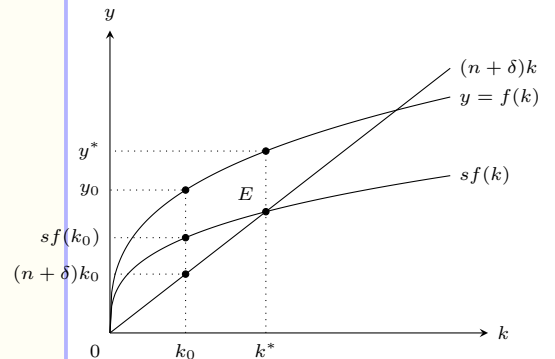

6.7 Liquidity trap

```

\begin{tikzpicture}[scale=.5,font=\scriptsize]
% \tzhelp lines(10,8)
\tzshoworigin
\tzaxes(10,8){$Y$}{$r$}
\tzline"LM"(1,2)(5,2)
\tzto[out=0,in=-95](5,2)(8,6){$LM$}[a]
\tzto[dashed,out=0,in=-95](5,2)(9.5,6){$LM'$}[a]
\tzLFn"IS"(4,2){-1}[5:1]{$IS$}[a]
\tzLFn[dashed]<1,0>"ISa"(4,2){-1}[5:1]{$IS'$}[a] %%
\tzXpoint{IS}{LM}(E)
\tzXpoint{ISa}{LM}(E1)
\tzproj(E){$Y^*$}{$r_0$}
\tzprojx(E1){$Y'$}
\end{tikzpicture}

```

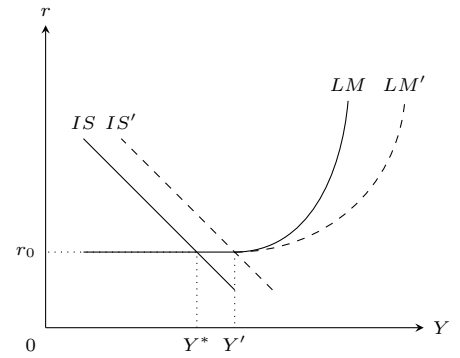

LM curves are drawn with two paths. To shift the IS curve, `<shift coor>` is used. See Section 22.1 on page 161 for more details.

```

\begin{tikzpicture}[scale=.5,font=\scriptsize]
% \tzhelp lines(10,8)
\tzshoworigin
\tzaxes(10,8){$m$}{$r$}
\tzto[out=-88,in=180](1,7)(5,2)
  <--(9,2) node [r] {$m^d$}> % code.append
\tzvfnat{5}[0:6]{$m^s_0$}[a]
\tzvfnat{6.5}[0:6]{$m^s_1$}[a]
\tzvfnat{8}[0:6]{$m^s_2$}[a]
\tzprojy(5,2){$r_0$}
\tzticksx{5/{$m_0$},6.5/{$m_1$},8/{$m_2$}}
\end{tikzpicture}

```

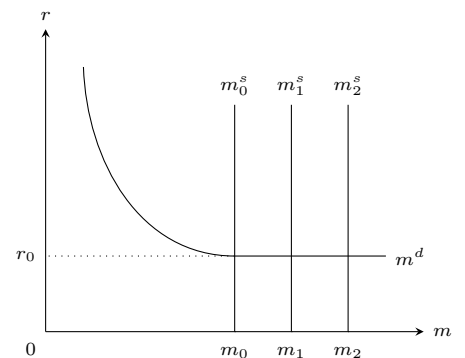

The money demand (m_d) curve is drawn with one path. To do this, `<code.append>` is used. See Section 13.1 on page 87 for more details.

6.8 Miscellany

```

\begin{tikzpicture}[font=\scriptsize]
\def\z{1}
\tzcoors
(0,0)(A)
($$(A) + (45:\z)$$)(B)
($$(B) + (45:\z)$$)(C)
($$(A) + (-45:\z)$$)(D)
($$(D) + (45:\z)$$)(E)
($$(E) + (45:\z)$$)(F)
($$(D) + (-45:\z)$$)(G)
($$(G) + (45:\z)$$)(H)
($$(H) + (45:\z)$$)(I);

\foreach \a in {A,...,I}
{ \tzdot*(\a){\a}
}

\tzlines(D)(A)(B)(C)(F)(E)(D)(G)(H)(I)(F);
\tzlines[red](B)(E)(H);
\end{tikzpicture}

```

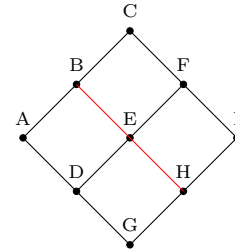

```

\begin{tikzpicture}[scale=1,font=\scriptsize]
\tzaxes(4,4){alternatives}{preferences}
\tzticksx{1/$$,2/$$,3/$$}
\tzplot[mark=ball](1,3)(2,2)(3,1){A}[0];
\tzplot[mark=*](1,2)(2,1)(3,3){B}[0];
\tzplot[mark=+](1,1)(2,3)(3,2){C}[0];
\end{tikzpicture}

```

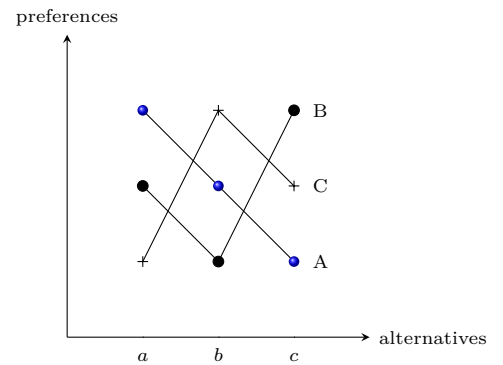

```

\begin{tikzpicture}[scale=1,font=\scriptsize]
\tzaxes(4,4){alternatives}{preferences}
\tzticksx{1/$$,2/$$,3/$$}
\foreach \x in {1,2,3}
{ \foreach \y in {1,2,3}
{ \tzdot*(\x,\y)
}
}
\tzlines(1,3)(2,2)(3,1){A}[r];
\tzlines(1,2)(2,1)(3,3){B}[r];
\tzlines(1,1)(2,3)(3,2){C}[r];
\end{tikzpicture}

```

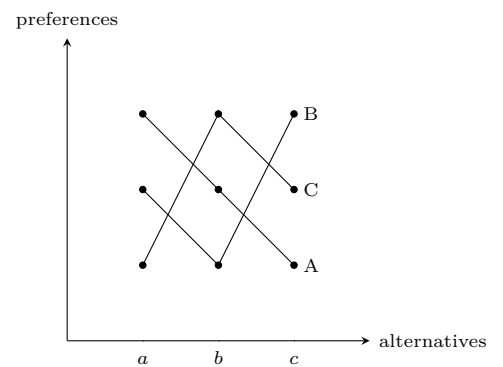

Part III

Points, Lines, Curves, and Angles

7 Getting Ready

7.1 Styles: `tzdotted`, `tzdashed`, `tzhelplines`

The styles `tzdotted`, `tzdashed`, and `tzhelplines` are defined as follows:

```
% styles: tzdotted, tzdashed, tzhelplines
\tikzset{%
  tzdotted/.style={line cap=round,dash pattern=on 0pt off 1cm/(#1)},
  tzdotted/.default=10
}
\tikzset{%
  tzdashed/.style={dashed=none,dash pattern=on 5mm/(#1) off 5mm/(#1)},
  tzdashed/.default=10
}
\tikzset{%
  tzhelplines/.style={help lines,-,tzdotted}
}
```

The styles `tzdotted` and `tzdashed` print 10 dots and 10 dashes per 1cm, respectively, by default. The style `tzhelplines` uses `tzdotted` by default.

7.2 `\tzhelplines`, `\tzhelplines*`

`\tzhelplines` draws grid from the first coordinate to the second coordinate. If only one coordinate is specified, then the first coordinate is regarded as $(0,0)$.

The starred version `\tzhelplines*` uses the grid as a *bounding box*.

```
% syntax: minimum
\tzhelplines(<coor>)
% syntax: full
\tzhelplines[<opt>](<coor1>)(<coor2>)
% defaults
[help lines,tzdotted=10](<m>)()
% (<m>): mandatory argument
```

Here, `<m>` stands for a *mandatory* argument.

```
\tzhelplines(4,3) % works similarly to:
\draw [help lines] (0,0) grid (4,3);

\tzhelplines(1,1)(4,3) % works similarly to:
\draw [help lines] (1,1) grid (4,3);
```

By default, `\tzhelplines` prints grid with 10 dots per 1cm. `\tzhelplines` with the option value `[tzdotted=<n>]` prints `<n>` dots per 1cm. (That is, the default value is `tzdotted=10`.)

```

% \tzhelplines
\begin{tikzpicture}
\tzhelplines(2,2)
\draw [help lines] (3,0) grid (5,2);
\end{tikzpicture}

```

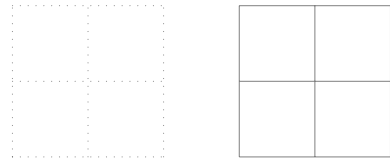

```

% tzdotted: (default: 10 dots per 1cm)
\begin{tikzpicture}
\tzhelplines[thick](1,2)
\tzhelplines[thick,tzdotted=20](2,0)(3,2) % 10 dots
\tzhelplines[thick,tzdotted=5](4,0)(5,2) % 20 dots
\end{tikzpicture}

```

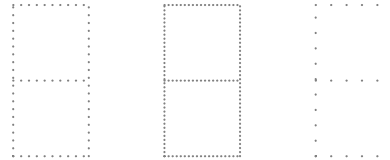

With the option value, [tzdotted=<n>/<d>], \tzhelplines prints <n> dots per <d>cm. Similarly for tzdashed.

```

% tzdotted, tzdashed
\begin{tikzpicture}
\tzhelplines[thick,tzdashed](4,2)
\tzhelplines[thick,step=.5](4,2)
\end{tikzpicture}

```

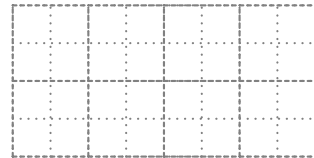

```

% scaled: 7 dots per .7cm (10 dots per hard 1cm)
\begin{tikzpicture}[scale=.7]
\tzhelplines[tzdashed](4,3)
\tzhelplines[step=.5](4,3)
\end{tikzpicture}

```

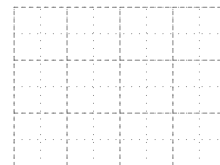

```

% scaled: 10/.7 means 10 dots per .7cm
\begin{tikzpicture}[scale=.7]
\tzhelplines[tzdashed=10/.7](4,3) %%
\tzhelplines[step=.5,tzdotted=10/.7](4,3) %%
\end{tikzpicture}

```

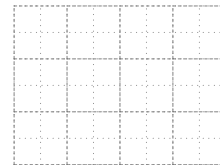

7.3 \tzbbox: A bounding box

\tzbbox sets a bounding box.

```

% syntax
\tzbbox(<coor1>)(<coor2>)
% defaults
(0,0)(<m>)
% <m>: mandatory

```

```

\tzbbox(-1,-1)(4,3) % is an abbreviation of:
\path [ use as bounding box ] (-1,-1) rectangle (4,3);

```

If only one coordinate is specified, the first coordinate is regarded as (0,0).

8 Dots

8.1 `\tzcdot(*)`: A small circle

A dot is usually expressed by a small circle. `\tzcdot` prints a circle dot \circ .

The starred version `\tzcdot*` prints a filled circle dot \bullet . The *radius* of the circle is 1.2pt, by default.

```
% syntax: minimum
\tzcdot(<coord>)
% syntax: medium
\tzcdot*(<coord>){<label>}[<angle>](<radius>)
% syntax: full
\tzcdot* [<opt>] <shift coord> (<coord>){<label>}[<[label opt]angle>](<radius>)
% defaults
* [ solid, thin, tzcdot=1.2pt ] <> (<m>){} [] (1.2pt)
% tzcdot is a predefined key (in this package).
% <m>: mandatory
```

Here, `<m>` stands for a *mandatory* argument. All others are optional arguments.

How to change the size There are THREE WAYS to change the *radius* of a circle dot drawn by `\tzcdot`.

1. The simplest way is to use the *last parenthesis option*, like `\tzcdot(0,0)(3pt)`.

```
\tzcdot(0,0) % is an abbreviation of:
\draw (0,0) circle (1.2pt); % default radius=1.2pt
```

```
\tzcdot*(0,0)(3pt) % is an abbreviation of:
\draw [fill] (0,0) circle (3pt);
```

2. You can use the key-value option `[tzcdot=<dim>]`, like `\tzcdot[tzcdot=3pt](0,0)`, to change the *radius* of a circle dot. The `tzcdot` key is defined in the package. If both the `tzcdot` key-value and the last parenthesis option are used, the former wins.

```
\tzcdot*(1,1) % works like:
\draw [fill] (1,1) circle [radius=1.2pt]; % default radius=1.2pt
```

```
\tzcdot*[tzcdot=3pt] % works like:
\draw [fill] (0,0) circle [radius=3pt];
```

```
% \tzcdot(*)
\begin{tikzpicture}
\tzhelplines(4,2)
\tzcdot(0,0) \tzcdot[tzcdot=4pt](1,1)
\tzcdot*(2,1)(2pt) \tzcdot*(3,0)(3pt)
\end{tikzpicture}
```

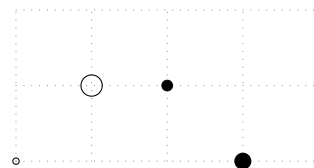

3. Another way to change the radius is to use a macro, like `\settzcdotradius{3pt}`. It is effective within the `tikzpicture` environment unless changed by `\settzcdotradius` again.

```
% \settzcdotradius
\begin{tikzpicture}
\tzhelpelines(4,2)
\settzcdotradius{4pt}
\tzcdot(0,0)      \tzcdot(1,1)
\tzcdot*(2,1)(2pt) \tzcdot*(3,0)
\end{tikzpicture}
```

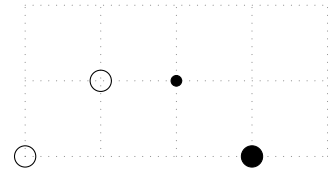

How to label You can add a label to a specified coordinate by adding the optional argument `{<label>}` immediately after `(<coord>)`. You can also change the `{<label>}` position by the option `[<angle>]`.

```
\tzcdot(0,0){A} % is an abbreviation of:
\draw (0,0) circle (1.2pt) node [label={:A}] {};

\tzcdot(0,0)(2pt){A}[[blue]0] % is an abbreviation of:
\draw (0,0) circle (2pt) node [label={[[blue]0:A]}] {};
```

```
% \tzcdot: labels
\begin{tikzpicture}
\tzhelpelines(4,3)
\tzcdot(0,0){A} % default position: 90 or above
\tzcdot[tzcdot=4pt](1,1){B}[0]
\tzcdot*(2,1){C}[45](2pt)
\tzcdot*(3,0){D}[-90](3pt)
\tzcdot(4,3){E}[-90](6pt)
\end{tikzpicture}
```

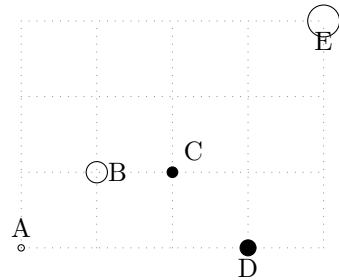

In TikZ, the distance from the coordinate center to a label does not depend on the size of circle dots.

How to change colors With the first optional argument `[<opt>]`, you can change the color of a dot. You can also change the color of a label, as shown in the following example.

```
% \tzcdot(*): color, fill
\begin{tikzpicture}
\draw [help lines] (0,0) grid (4,3);
\tzcdot(0,0){A}
\tzcdot*[red](1,0){\textbf{B}}[45]
\tzcdot*[red,fill=green](2,1){green}[[blue]0](10pt)
\tzcdot[tzcdot=2*7pt](3,2){big}[center]
\tzcdot*[fill=red,text=blue](4,3){D}(2*3pt)
\end{tikzpicture}
```

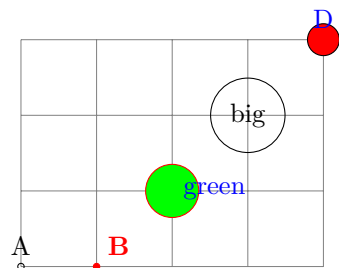

Shift Dots can be shifted by specifying the optional argument `<shift coord>` immediately before `(<coord>)`. The *empty* shift option `<>` is *not allowed*.

```

% \tzcdot: shift
\begin{tikzpicture}
\draw [help lines] (0,0) grid (4,3);
\tzcdot(0,0){A}
\tzcdot*[red]<0,2>(1,0){\textbf{B}}[45] % shift
\tzcdot*[red,fill=green](2,1){green}[[blue]0](10pt)
\tzcdot[tzcdot=2*7pt]<1,-1>(3,2){big}[center] % shift
\tzcdot*[fill=red,text=blue](4,3){D}(2*3pt)
\end{tikzpicture}

```

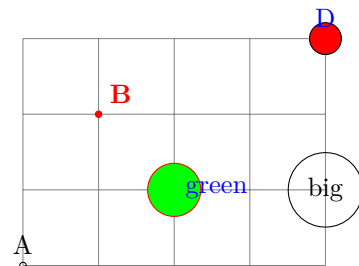

```

% \tzcdot: repeated
\begin{tikzpicture}
\tzhelplines(4,2)
\foreach \x in {0,...,4}
{ \foreach \A in {2,4,6,8}
{ \tzcdot[blue] (\x,0)(\A pt) } }
\foreach \x in {0,...,4}
{ \foreach \A in {2,4,6,8}
{ \tzcdot[red]<1,1>(\x,0)(\A pt) } } % shift
\end{tikzpicture}

```

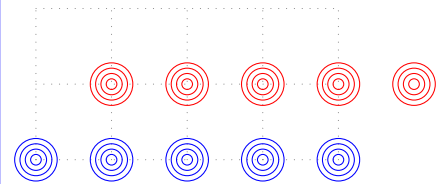

8.2 \tzcdots(*): Multiple circle dots

The macro `\tzcdots` takes an *arbitrary number of coordinates* as arguments to print multiple circle dots with the radius `1.2pt`, by default. You need to indicate when the iteration of an arbitrary number of coordinates ends, by typing a *semicolon* `;`. Let us call this kind of macro a *semicolon version* macro.

Remark:

- DO NOT FORGET to enter `';` at the end of iteration.
- Without the semicolon `;`, an error occurs with the the *error message*:

! Package tzplot Error: You may have forgotten a semicolon here or above!

The starred version `\tzcdots*` prints multiple filled dots.

```

% syntax: minimum
\tzcdots*(<coor>)(<coor>)..repeated..(<coor>) ;
% syntax: full
\tzcdots* [<opt> <shift coor> (<coor>){<label>} [<[label opt]angle>]
..repeated.. (){}[] ; (<dot radius>)
% defaults
*[tzcdot=1.2pt]<>(<m>){}[]..repeated..(){}[] ; (1.2pt)

```

```

% \tzcdots(*)
\begin{tikzpicture}
\tzhelplines(4,3)
\tzcdots(0,0)(1,1)(2,1)(3,2)(4,0);
\tzcdots*(0,3)(1,2)(2,2)(3,3)(4,3); % semicolon
\end{tikzpicture}

```

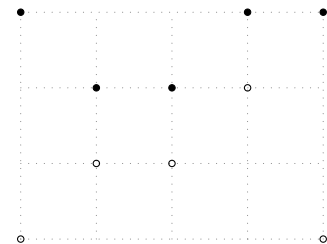

How to label Each coordinate can be followed by the optional arguments {<label>} and [<angle>] to label dots. So the repeating pattern is the triple (<coor>){<label>}[<angle>]. In TikZ, <angle> can have the label option like <[label opt]angle>.

```

% \tzcdots: label
\begin{tikzpicture}
\tzhelplines(4,3)
\tzcdots(0,0){A}
      (1,1)
      (2,1){C}[0]
      (3,2){D}[-90]
      (4,0){E}[[red,draw]45];
\tzcdots*(0,3)(1,2){B}[-135](2,2){C}[45](3,3)(4,3);
\end{tikzpicture}

```

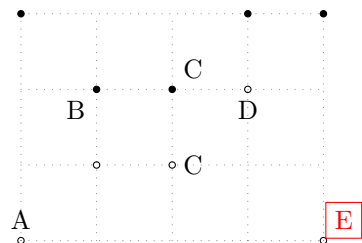

How to change the size of dots There are THREE WAYS of changing the *radius* of dots.

1. The simplest way is to use the *last* parenthesis optional argument, *after the semicolon*.
2. Another way is to use the `tzcdot` key, like `\tzcdots[tzcdot=3pt]...`. If both options are used the key-value option wins.
3. You can also use the macro `\setztzcdotradius`. The effect remains within the `tikzpicture` environment unless it is changed again.

```

% \tzcdots: size (radius)
\begin{tikzpicture}
\tzhelplines(4,3)
\setztzcdotradius{3pt}
\tzcdots(0,0)(1,0){3pt};
\tzcdots*(1,1)(2,1){1pt};(1pt) % simplest
\tzcdots[tzcdot=5pt](2,2)(3,2){5pt};
\tzcdots*(3,3)(4,3){3pt};
\end{tikzpicture}

```

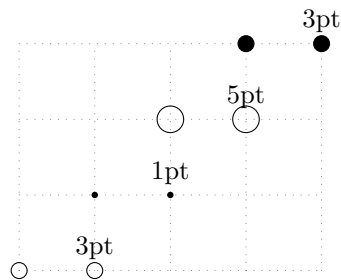

How to change colors With the first optional argument [<opt>], you can change the color of dots. You can also change the color of all labels at once using the first optional argument, like `\tzcdots[text=red]...` as shown in the following example.

```

% \tzcdots: color
\begin{tikzpicture}
\tzhelplines(4,3)
\setztzcdotradius{3pt}
\tzcdots*[red]
  (0,0)(1,1){\textbf{Ben}}[[blue]-90](2,1)(3,0);
\tzcdots*[thick,blue,fill=green,text=red]
  (1,2){A}(2,2){Ben}[[blue]-90](3,2){C}(4,2){D};(4pt)
\tzcdots*[blue]
  (1,3){A}(2,3){B}(3,3){C}(4,3){D};
\end{tikzpicture}

```

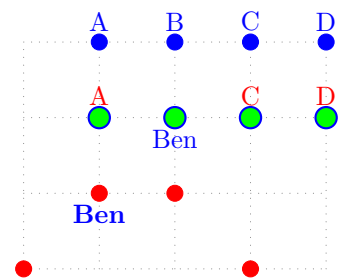

Shift You can move the coordinates of dots by specifying `<shift coor>` option immediately before the first coordinate.

```

% \tzcdots: shift
\begin{tikzpicture}
\tzhelplines(4,3)
\tzcdots[red] (0,0){A}(1,1)(2,1){C}(3,2){D}[0](4,0){E};
\tzcdots*<0,1>(0,0){A}(1,1)(2,1){C}(3,2){D}[0](4,0){E};
\end{tikzpicture}

```

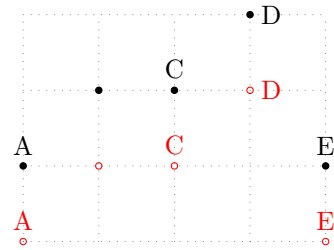

8.3 \tzdot(*): A single node dot

The macro `\tzdot` prints a small circle node `o`, as a dot, with the *diameter* (or *minimum size*) of 2.4pt, by default.

The starred version `\tzdot*` prints a filled dot `.`.

```

% syntax: minimum
\tzdot(coor)
% syntax: medium
\tzdot*(<coor>){<label>}[<angle>](<dot size>)
% syntax: full
\tzdot* [<node opt>] <shift coor> (<coor>){<label>}[<[label opt]angle>] (<dot size>)
% defaults
*[ tzdot=2.4pt ] <> (<m>){} [] (2.4pt)
% the style tzdot is predefined
% (<m>): mandatory

```

`\tzdot(*)` accepts one mandatory argument, denoted by `<m>`. All others are optional. The style `tzdot` is predefined in this package as follows:

```

% style: tzdot
\tikzset{
  tzdot/.style={draw,circle,solid,thin,inner sep=0pt,minimum size=#1},
  tzdot/.default=2.4pt
}

```

8.3.1 THREE WAYS to change the size of node dots

There are THREE WAYS to change the *diameter* (or *minimum size*) of a node dot drawn by `\tzdot(*)`.

1. Use the predefined style `tzdot` in the first optional argument, like `\tzdot[tzdot=5pt](0,0)`, which gives the same result as `\tzdot[minimum size=5pt](0,0)`.

```

\tzdot(0,0) % works like:
\path (0,0) node [tzdot=2.4pt] {}; % default size
% or equivalently
\node [tzdot,minimum size=2.4pt] at (0,0) {};

```

2. The simplest way is to use the *last parenthesis optional argument*, like `\tzdot(0,0)(5pt)`, which yields the same result as in `\tzdot[tzdot=5pt](0,0)`. If both options are used, the `tzdot` (or *minimum size*) option overwrites the last parenthesis option.

```

% \tzdot(*)
\begin{tikzpicture}
\tzhelplines(4,2)
\tzdot(0,0)      \tzdot[tzdot=8pt](1,1)
\tzdot*(2,1)(4pt) \tzdot*(3,0)(6pt)
\end{tikzpicture}

```

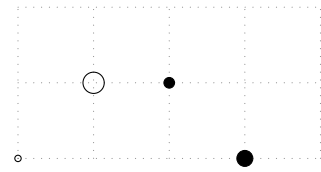

3. You can use the macro `\settzdotsize` to change the size (or diameter) of all node dots drawn by `\tzdot*`. It is effective within the `tikzpicture` environment unless changed again.

```

% \settzdotsize
\begin{tikzpicture}
\tzhelplines(4,2)
\settzdotsize{8pt}
\tzdot(0,0)      \tzdot(1,1)
\tzdot*(2,1)(4pt) \tzdot*(3,0)
\end{tikzpicture}

```

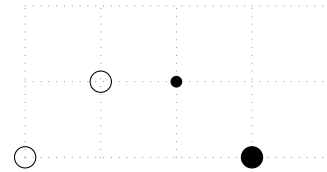

8.3.2 How to label

You can add a label to a specified coordinate by specifying the optional argument `{<label>}` immediately after the coordinate `<coord>`. You can also change the label position by the option `[<angle>]` or `[<label opt>angle]` following `{<label>}`.

```

\tzdot(0,0){A}(3pt)      % works like:
\path (0,0) node [tzdot=3pt,label={:A}] {};

\tzdot*(0,0){A}[[red]0](3pt) % works like:
\path (0,0) node [fill,tzdot=3pt,label={:[red]0:A}] {};

```

```

% \tzdot: labels
\begin{tikzpicture}
\tzhelplines(4,3)
\tzdot(0,0){A}
\tzdot(1,1){B}[0](8pt)
\tzdot*(2,1){C}[45](4pt)
\tzdot*(3,0){D}[-90](6pt)
\tzdot(4,3){E}[[red,draw]br](12pt) % string replacement
\end{tikzpicture}

```

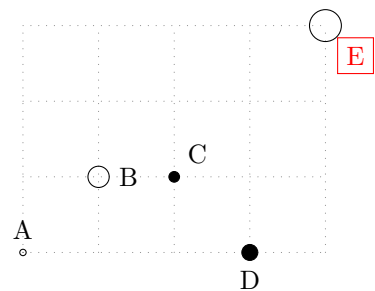

String replacement (See also Section 2.3.5 on page 5.)

- In TikZ, to place labels you can use `<angle>` or the positional words such as `[above]`, `[below]`, `[center]` (*not* `[centered]` for the main node option), `[below right]`, and so on.
- *Just to avoid frequent coding errors*, from the version 2 of the `tzplot` package, you can use the abridged strings `[a]`, `[b]`, `[c]`, `[br]`, and so on.
- So `[[blue,draw]-45]`, `[[blue,draw]below right]`, and `[[blue,draw]br]` give the same result.

Unlike `\tzcdot`, the `\tzdot`'s label position depends on the size of a circle node. In TikZ jargon, `{<label>}` is in a *label node* for a *main node* that is a circle node with no text in it, so `<label>` moves accordingly as the main node dot gets bigger or smaller.

8.3.3 How to change colors and shapes

With the first optional argument [`<node opt>`], you can change of the color or shape of dots. You can also change the label color using [`<label opt>`] as shown in the following example.

Remark:

- [`<node opt>`] is for options of *main nodes*, [`<label opt>`] is for options of *label nodes*.
- [`<label opt>`] is used in the form of [`<[<label opt>]angle>`].

```
% \tzdot: color
\begin{tikzpicture}
\draw [help lines] (0,0) grid (4,3);
\tzdot(0,0){A}
\tzdot*[red](1,0){\textbf{B}}[45]
\tzdot*[red,fill=green](2,1){green}[[blue]0](2*10pt)
\tzdot[tzdot=4*7pt](3,2){big}[center]
\tzdot*[fill=red](4,3){D}(4*3pt)
\end{tikzpicture}
```

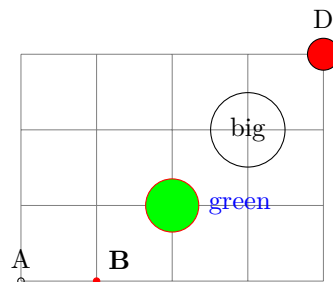

```
% \tzdot: shape
\begin{tikzpicture}
\draw [help lines] (0,0) grid (4,3);
\tzdot[regular polygon](0,0){A}(10pt)
\tzdot*[red](1,0){\textbf{B}}[45]
\tzdot*[red,green,rectangle](2,1){green}[0](2*10pt)
\tzdot[tzdot=4*7pt](3,2){big}[center]
\tzdot*[fill=red,star](4,3){D}(4*3pt)
\end{tikzpicture}
```

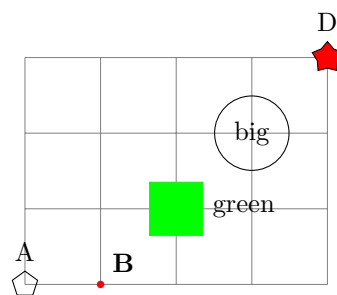

8.3.4 How to move: shift

Dots can be shifted by specifying the optional argument `<shift coor>` immediately before (`<coor>`). The empty shift option `<>` is not allowed.

```
% \tzdot: shift
\begin{tikzpicture}
\draw [help lines] (0,0) grid (4,3);
\tzdot[regular polygon](0,0){A}(10pt)
\tzdot*[red]<0,2>(1,0){\textbf{B}-shifted}[45] % shift
\tzdot*[red,green,rectangle](2,1){green}[0](2*10pt)
\tzdot[tzdot=4*7pt]<1,-1>(3,2){big}[center] % shift
\tzdot*[fill=red,star](4,3){D}(4*3pt)
\end{tikzpicture}
```

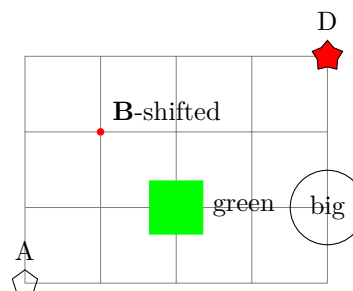

```
% \tzdot: repeated
\begin{tikzpicture}
\tzhelplines(4,2)
\foreach \x in {0,...,4}
{ \foreach \A in {1,2,3,4}
{ \tzdot[blue] (\x,0)(2*\A mm) } }
\foreach \x in {0,...,4}
{ \foreach \A in {1,2,3,4}
{ \tzdot[green]<1,1>(\x,0)(2*\A mm) } } % shift
\end{tikzpicture}
```

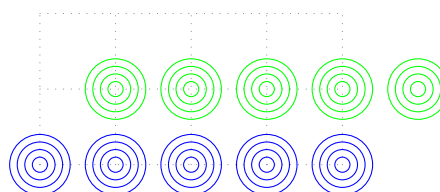

8.3.5 Comparison: `\tzdot` and `\tzcdot`

The most important difference between `\tzcdot` and `\tzdot` is that `\tzcdot` is affected by TikZ's scaling factor, but `\tzdot` is not. This is critical when `xscale` is not equal to `yscale`.

```
\begin{tikzpicture}[xscale=1.6,yscale=.8]
\tzhelplines(3,3)
\tzcdot(0,0)(3pt) % distorted
\tzdot(1,0)(6pt)
\tzcdots*(1,1)(2,1)(3,1);(2pt) % distorted
\tzdots*(1,2)(2,2)(3,2);(4pt)
\end{tikzpicture}
```

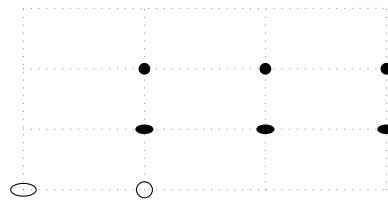

The following table further shows the differences between them.

<i>% concept</i>	<i>% single</i>	<i>% multi</i>	<i>% size control</i>	<i>% [key=default size]</i>
node [circle]	<code>\tzdot</code>	<code>\tzdots</code>	<code>\settzdotsize</code>	[tzdot=2.4pt] <i>% diameter</i>
circle	<code>\tzcdot</code>	<code>\tzcdots</code>	<code>\settzcdotradius</code>	[tzcdot=1.2pt] <i>% radius</i>

Remark:

- In TikZ, a ‘node’ is ‘not’ affected by ‘scaling’ unless the TikZ option `transform shape` is used together. `\tzdot` is also useful for labelling a large dot.
 - In `\tzdot`, `<label>` is a label in a *label node* for a node dot (as a *main node*). So if a main node dot gets larger or smaller, its label moves accordingly. (Unlike, the labels with `\tzcdot` or `\tzcdots`.)
 - The position of `<label>` in `\tzcdot` does not depend on the size of dots.
- The package `tzplot` takes `\tzdot` as a *standard dot*, not `\tzcdot`. So, you can apply the THREE WAYS (on page 46) to change the size of any standard dots.

8.4 `\tzdots(*)`: Multiple node dots

`\tzdots` takes an arbitrary number of coordinates as arguments to print multiple circle node dots with the *diameter* (or *minimum size*) of 2.4pt, by default.

This is a *semicolon version* macro, with the repeating pattern `(<coor>){<label>}[<angle>]`, which means that you need to type a *semicolon* ‘;’ at the end of the coordinate repetition. The *semicolon* says, “*The repetition ends here.*”

Remark:

- DO NOT FORGET to enter ‘;’ at the end of iteration.
- Without the semicolon ‘;’, an error occurs with the error message:

```
! Package tzplot Error: You may have forgotten a semicolon here or above!
```

The starred version `\tzdots*` prints multiple filled node dots.

```
% syntax: minimum
\tzdots*(<coor>)(<coor>)..repeated..(<coor>) ;
% syntax: full
\tzdots* [<node opt>] <shift coor> (<coor>){<label>}[<[label opt]angle>]
..repeated.. (){}[] ; (<dot size>)

% defaults
*[tzdot=2.4pt]<> (<m>){}[] ..repeated.. (){}[] ; (2.4pt)
```



```

% \tzdots(*)
\begin{tikzpicture}
\tzhelplines(4,3)
\tzdots(0,0)(1,1)(2,1)(3,2)(4,0);
\tzdots*(0,3)(1,2)(2,2)(3,3)(4,3); % semicolon
\end{tikzpicture}

```

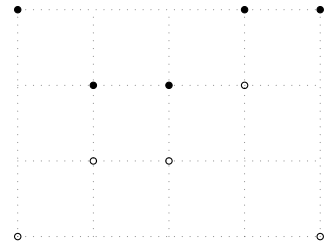

How to label Each coordinate can be followed by the optional arguments {<label>} and [<angle>] to label dots. So the triple (<coord>){<label>}[<angle>] is the whole repeating pattern. (To avoid frequent coding errors, you can also use *string replacement* instead of angles. See also Section 2.3.5 on page 5)

```

% \tzdots: label
\begin{tikzpicture}
\tzhelplines(4,3)
\tzdots(0,0){A}
(1,1)
(2,1){C}[0]
(3,2){D}[b] % string replacement
(4,0){E};
\tzdots*(0,3)(1,2){B}(2,2){C}[45](3,3)(4,3);
\end{tikzpicture}

```

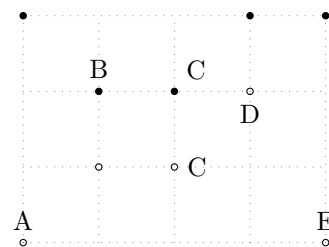

How to change the size of dots There are THREE WAYS of changing the *diameter* of node dots, as discussed in Section 8.3.1 on page 46.

1. The simplest way is to use the *last* parenthesis optional argument, *after the semicolon*.
2. Another way is to use the style `tzdot`, like `\tzdots[tzdot=3pt]...`. If both options are used the `tzdot` option style wins.
3. You can also use the macro `\setztzdotsize`. The effect remains within the `tikzpicture` environment unless it is changed again.

```

% \tzdots: size (diameter)
\begin{tikzpicture}
\tzhelplines(4,3)
\setztzdotsize{3mm}
\tzdots(0,0)(1,0){3mm};
\tzdots*(1,1)(2,1){2mm};(2mm) % simplest
\tzdots[tzdot=4mm](2,2)(3,2){4mm};
\tzdots*(3,3)(4,3){3mm};
\end{tikzpicture}

```

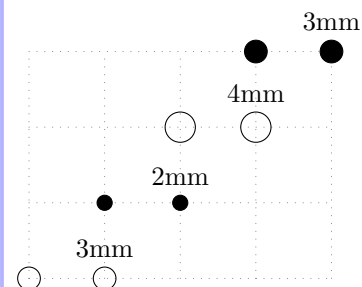

How to change colors With the first optional argument [<node opt>] you can change the color of node dots. You can also change the color of each label by [<label opt>].

```

% \tzdots: color
\begin{tikzpicture}[->]
\tzhelpelines(4,3)
\setztzdotsize{6pt}
\tzdots*[red]
(0,0)(1,1){\textbf{Ben}}[[blue]-90](2,1)(3,0);
\tzdots*[thick,blue,fill=green]
(1,2){A}(2,2){Ben}[[red]-90](3,2){C}(4,2){D};(8pt)
\tzdots*[blue]
(1,3){A}(2,3){B}(3,3){C}(4,3){D};
\end{tikzpicture}

```

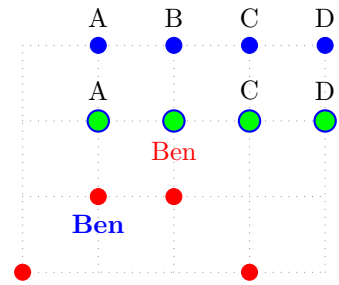

Remark:

- [`<node opt>`] is the option of a *main node* and [`<label opt>`] is the option of a *label node*.
- [`<label opt>`] is used in the form of [`<<label opt>angle>`], like `[[red]90]`.
- You can control all labels together using `every label/.style` as in the following examples:

```

% \tzdots: every label/.style
\begin{tikzpicture}
\tzhelpelines(4,3)
\setztzdotsize{6pt}
\tzdots*[red]
(0,0)(1,1){\textbf{Ben}}[[blue]-90](2,1)(3,0);
\tzdots*[thick,blue,fill=green]
(1,2){A}(2,2){Ben}[[red]-90](3,2){C}(4,2){D};(8pt)
\tikzset{every label/.style={draw,text=red}} %%
\tzdots*[blue]
(1,3){A}(2,3){B}(3,3){C}(4,3){D}[0];
\end{tikzpicture}

```

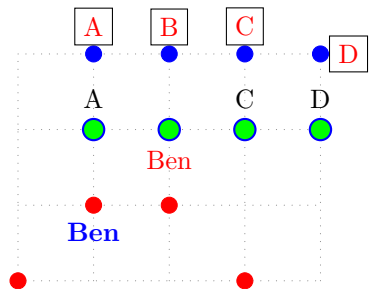

```

% every label/.style
\begin{tikzpicture}[every label/.style={draw,text=red}]
\tzhelpelines(4,3)
\tzdots*
(0,0){Ace}[[font=\LARGE\ttfamily]-90]
(2,1){\textbf{Bob}}[[blue]135]
(3,2){C_1\N_o}[[align=center]0];
\end{tikzpicture}

```

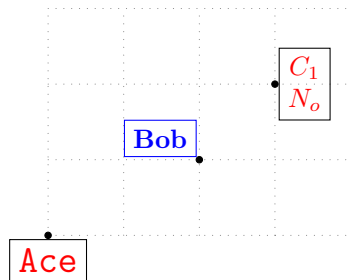

Shift You can move the coordinates of dots by specifying `<shift coor>` option immediately before the first coordinate. The *empty* shift option `<>` is *not allowed*.

```

% \tzdots: shift
\begin{tikzpicture}
\tzhelpelines(4,3)
\tzdots[red] (0,0){A}(1,1)(2,1){C}(3,2){D}[0](4,0){E};
\tikzset{every label/.style={red}}
\tzdots*<0,1>(0,0){A}(1,1)(2,1){C}(3,2){D}[0](4,0){E};
\end{tikzpicture}

```

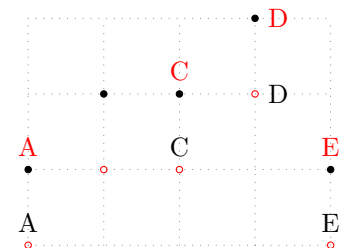

9 Coordinates

9.1 `\tzcoor` and `\tzcoor*`

9.1.1 `\tzcoor`

For example, `\tzcoor(0,0)(A)` means that the coordinate (0,0) is named (A).

```
\tzcoor(0,0)(A) % is an abbreviation of:
\path (0,0) coordinate (A);
% or
\coordinate (A) at (0,0);
```

```
% syntax: minimum
\tzcoor(<coor>)(<name>)
% syntax: medium
\tzcoor(<coor>)(<name>){<label>}[<angle>]
% syntax: full
\tzcoor<shift coor>(<coor>)(<name>){<label>}[<[label opt]angle>]
% defaults
<>(<m>)(<m>){} []
```

Here, `<m>` stands for ‘mandatory.’ `\tzcoor` takes two mandatory arguments in parenthesis.

How to label You can put a label to a coordinate by specifying the optional arguments `{<label>}` and `[<angle>]` immediately after `(<name>)`.

```
\tzcoor(0,0)(A){$A$}[0] % works like:
\path (0,0) coordinate [label={0:$A$}] (A);
```

```
% \tzcoor
\begin{tikzpicture}
\tzhelplines(4,3)
\tzcoor(0,0)(A){$A_1$} % TikZ default: 90 or above
\tzcoor(2,1)(B){$B_2$\\ending point}[[align=left,red]0]
\draw (A) -- (B);
\end{tikzpicture}
```

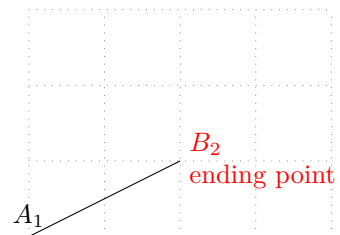

Shift You can move the coordinate by specifying the optional argument `<shift coor>` before `(<coor>)`. The *empty* shift option `<>` is *not allowed*.

```
% \tzcoor: shift
\begin{tikzpicture}
\tzhelplines(4,3)
\tzcoor<0,1>(0,0)(A){$A_1$} %%
\tzcoor(2,1)(B){$B_2$\\ending point}[[align=left,red]0]
\tzline(A)(B)
\end{tikzpicture}
```

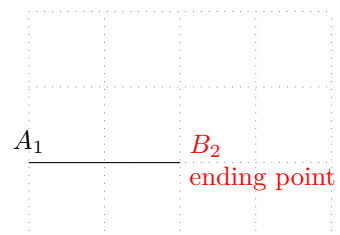

9.1.2 \tzcoor*

The starred version \tzcoor* works like \tzcoor with one exception. It prints a ‘node dot’ of the size 2.4pt, by default, at a specified coordinate.

```
% syntax: minimum
\tzcoor*(<coor>)(<coor name>)
% syntax: medium
\tzcoor*(<coor>)(<coor name>){<label>}[<angle>]
% syntax: full
\tzcoor* [<dot opt>] <shift coor>
          (<coor>)(<name>){<label>}[[<label opt>]<angle>](<dot size>)
% defaults
*[]<>(<m>)(<m>){}[] (2.4pt)
```

```
\tzcoor*(0,0)(A) % works like:
\path (0,0) coordinate (A);
\tzdot*(0,0)
```

```
\tzcoor(0,0)(A){$A$}[right] % works like:
\path (0,0) coordinate (A);
\tzdot*(0,0){$A$}[right]
```

```
% \tzcoor*
\begin{tikzpicture}
\tzhelplines(4,3)
\tzcoor*(0,0)(A){$A_1$} % TikZ default: 90 or above
\tzcoor*(30:3cm)(B){$B_2$}[[draw,blue]0]
\draw (A) -- (B);
\end{tikzpicture}
```

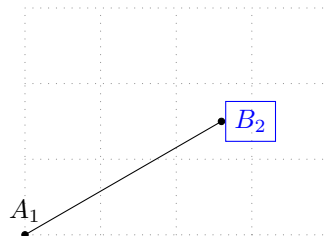

Changing the color and size of a dot You can change the color of a dot by specifying [*<dot opt>*], which is, in fact, TikZ’s node option. To change the size of dots, you can apply the THREE WAYS (see Subsection 8.3.1 on page 46).

```
% \tzcoor*: color, size
\begin{tikzpicture}
\tzhelplines(4,3)
\tzcoor(1,1)(A){A}
\tzcoor*(2,1)(B){B}[0]
\tzcoor*[red](1,2)(C){C}[[blue,draw]1] % abb
\tzcoor*[fill=none,tzdot=5pt](3,2)(D){D}[45]
\tzcoor*[blue,thick,fill=green](4,0)(E){E}[180](6pt)
\end{tikzpicture}
```

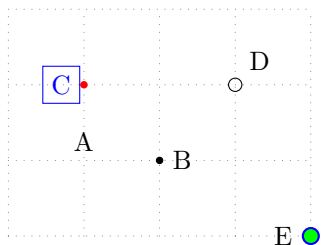

Shift The optional argument *<shift coor>* works just like in \tzcoor. The *empty* shift option *<>* is *not allowed*.

```

% \tzcoor*: shift
\begin{tikzpicture}
\tzhelplines(4,3)
\tzcoor* <0,1>(0,0)(A){$A_1$} %%
\tzcoor*(2,1)(B){$B_2$\\end point}[[align=left,red]0]
\tzline(A)(B)
\end{tikzpicture}

```

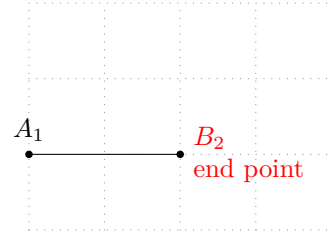

9.2 \tzcoors and \tzcoors*: Semicolon versions

9.2.1 \tzcoors

The macro `\tzcoors` takes an *arbitrary number of pairs* of coordinates and their names as arguments. For example, `\tzcoors(0,0)(A) (1,1)(B) (2,2)(C);` means that the coordinate (0,0) is represented by the name (A), (1,1) by (B), and (2,2) by (C).

```

% syntax: minimum
\tzcoors(<coor>(<name>..repeated..(<coor>)(<name>);
% syntax: full
\tzcoors <shift coor>(<coor>)(<name>){<label>}[<[label opt]angle>]
..repeated.. ()(){}[];
% defaults
<> (<m>)(<m>){}[] ..repeated.. ()(){}[];

```

This is a *semicolon version* macro. The quadruple `(<coor>)(<name>){<label>}[<angle>]` is the whole repeating pattern. It is required to type a *semicolon* ‘;’ to indicate when the coordinate repetition ends.

```

\tzcoors (0,0)(A) (1,1)(B) (2,1)(C) (3,0)(D); % works like:
\path (0,0) coordinate (A)
(1,1) coordinate (B)
(2,1) coordinate (C)
(3,0) coordinate (D);

```

```

\tzcoors (0,0)(A) (1,1)(B) (2,1)(C){C}[0] (3,0)(D){D}[90]; % works like:
\path (0,0) coordinate (A)
(1,1) coordinate (B)
(2,1) coordinate [label={0:C}] (C)
(3,0) coordinate [label={90:D}] (D);

```

You can add a label to each specified coordinate by adding the optional arguments `{<label>}` and `[<angle>]` immediately after `(<name>)`.

```

% \tzcoors
\begin{tikzpicture}
\tzcoors (0,0)(A){Ace}[[font=\LARGE\ttfamily]-90]
(2,1)(B){\textbf{Bob}}[[blue]135]
(3,2)(C){$C_1$\\$N_o$}[[align=center]0];
\draw (A) -- (B) -- (C);
\end{tikzpicture}

```

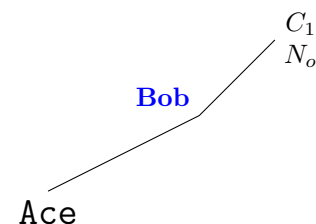

By the option `<shift coor>`, all specified coordinates are shifted. The *empty* shift option `<>` is *not allowed*.

```

% \tzcoors
\begin{tikzpicture}
\tzhelplines(4,3)
\tzcoors (0,0)(A) (1,1)(B) (2,1)(C){C} (3,0)(D);
\tzlines(A)(B)(C)(D);
% shift
\tzcoors <1,1> (0,0)(A) (1,1)(B) (2,1)(C){C} (3,0)(D);
\tzlines[dashed](A)(B)(C)(D);
\end{tikzpicture}

```

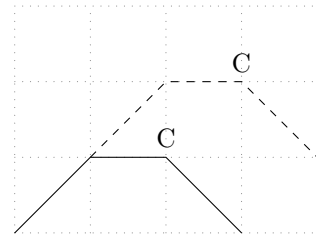

9.2.2 \tzcoors*

The starred version `\tzcoors*` takes an *arbitrary number of pairs* of coordinates and names as mandatory arguments to print node dots at the coordinates.

The full repeating pattern is `(<coor>)(<name>){<label>}[<angle>]`. It is required to type a *semicolon* ‘;’ to indicate when the iteration of coordinates ends.

```

% syntax: minimum
\tzcoors*(<coor>)(<name>)..repeated..(<coor>)(<name>) ;
% syntax: full
\tzcoors*[<dot opt>]<shift coor>(<coor>)(<name>){<label>}[<[label opt]angle>]
..repeated.. ()(){}[] ; (<dot size>)
% defaults
*[]<> (<m>)(<m>){}[] ..repeated.. ()(){}[] ; (2.4pt)

```

You can label each dot by specifying the optional arguments `{<label>}` and `[<angle>]` after the pair `(<coor>)(<name>)`.

```

% \tzcoors*
\begin{tikzpicture}
\tzhelplines(4,3)
\tzcoors*(0,0)(A)
(1,1)(B){B}
(2,1)(C)
(3,3)(D){D}[0] ; % semicolon
\end{tikzpicture}

```

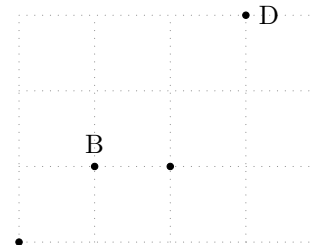

You can change the dot color by `[<dot opt>]` and the label color by `[<label opt>]`. You can apply the THREE WAYS (on page 46) to change the dot size. The simplest way of changing the dot size is to specify the *last* (even after the semicolon) parenthesis option `(<dot size>)`.

```

% \tzcoors*
\begin{tikzpicture}
\tzhelplines(4,3)
\tzcoors*[red] (0,0)(A)
(1,1)(B){B}
(2,1)(C)
(3,3)(D){D}[[blue]0] ; (6pt)
\end{tikzpicture}

```

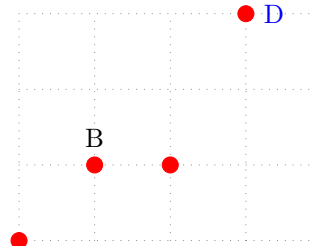

By specifying the optional argument `<shift coor>` immediately before the first coordinate, you can move all specified coordinates. The *empty* shift option `<>` is *not allowed*.

```

% \tzcoors*: shift
\begin{tikzpicture}
\tzhelplines(4,3)
\settzdotsize{6pt}
\tzcoors*[red]      (0,0)(A)(1,1)(B)(2,1)(C)(3,3)(D);
\settzdotsize{4pt}
\tzcoors*[blue]<.5,0>(0,0)(A)(1,1)(B)(2,1)(C)(3,3)(D);
\end{tikzpicture}

```

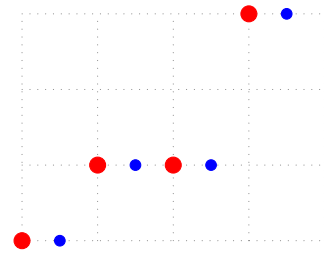

9.3 \tzcoorsquick and \tzcoorsquick*: Semicolon versions

9.3.1 \tzcoorsquick

You can see the coordinate array at a glance using `\tzcoorsquick`, which displays specified names as text at the center (by default) of the coordinates.

```

% syntax: minimum
\tzcoorsquick(<coor>(<name>)..repeated..(<coor>(<name>);
% syntax: full
\tzcoorsquick<shift coor>(<coor>(<name>){<label>}[<[label opt]angle>]
..repeated.. ()(){}[];
% defaults
<> (<m>)(<m>){}[center] ..repeated.. ()(){}[];

```

```

% \tzcoorsquick
\begin{tikzpicture}
\tzhelplines(4,3)
\tzcoorsquick(0,0)(A)
(1,1)(Ben)
(2,1)(Cate)
(3,2)(Daniel); % semicolon
\end{tikzpicture}

```

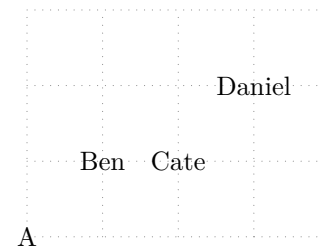

A label can be suppressed by the empty braces `{}`. You can move the coordinates by specifying `<shift coor>` immediately before the first coordinate. The *empty* option `<>` is *not allowed*.

```

% \tzcoorsquick: shift, color
\begin{tikzpicture}
\tzhelplines(4,3)
\tzcoorsquick
(0,0)(A) (1,1)(Ben) (2,1)(Cate){} (3,2)(Daniel);
\tikzset{every label/.style={blue}}
\tzcoorsquick <0,1>
(0,0)(A) (1,1)(Ben) (2,1)(Cate){} (3,2)(Daniel);
\end{tikzpicture}

```

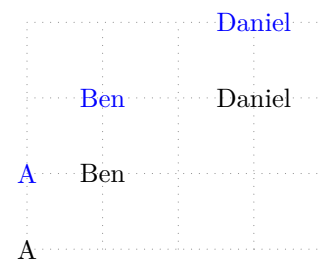

9.3.2 \tzcoorsquick*

The starred version `\tzcoorsquick*` prints node dots on the coordinates and displays the names above (or 90 degree from) the dots, by default.

```

% syntax: minimum
\tzcoorsquick*(<coor>)(<name>)..repeated..(<coor>)(<name>) ;
% syntax: full
\tzcoorsquick* [<dot opt>] <shift coor> (<coor>)(<name>){<label>} [<[label opt]angle>]
..repeated.. ()(){}[] ; (<dot size>)
% defaults
*[ tzdot=1.2pt ] <> (<m>)(<m>){}[] ..repeated.. ()(){}[] ; (2.4pt)

```

```

% \tzcoorsquick*
\begin{tikzpicture}
\tzhelplines(4,3)
\tzcoorsquick*(0,0)(A) (1,1)(Ben)
(2,1)(Cate) (3,2)(Daniel);
\end{tikzpicture}

```

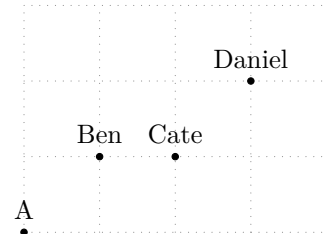

A label can be suppressed by the empty braces {}. You can change the dot size using the THREE WAYS (on page 46). You can shift the coordinate by specifying <shift coor> immediately before the first coordinate. The *empty* shift option <> is *not allowed*.

```

% \tzcoorsquick*: size, color, shift
\begin{tikzpicture}
\tzhelplines(4,3)
\tzcoorsquick*
(0,0)(A) (1,1)(Ben) (2,1)(Cate){} (3,2)(Daniel);
\tikzset{every label/.style={blue}}
\tzcoorsquick*[blue]<0,1>
(0,0)(A) (1,1)(Ben) (2,1)(Cate){} (3,2)(Daniel);(6pt)
\end{tikzpicture}

```

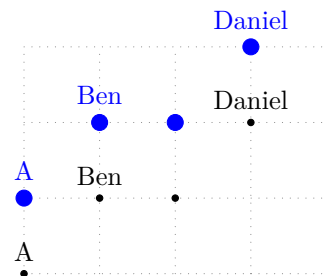

Remark: The first optional argument [<dot opt>] of \tzcoorsquick* is for only dots. You can use the TikZ option every label/.style={...} to control all the labels together. You can also control each labels using [<label opt>] for each coordinate.

```

% \tzcoorsquick*: every label/.style
\begin{tikzpicture}
\tzhelplines(4,3)
\tikzset{every label/.style={draw,red}} %%
\tzcoorsquick*[fill=none,blue,very thick]
(0,0)(A) (1,1)(B-1) (2,1)(C) (3,3)(D) [[blue]-45];(8pt)
\end{tikzpicture}

```

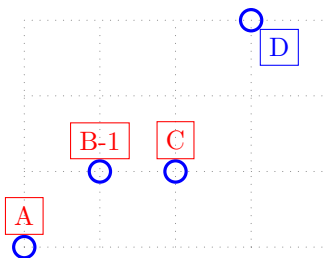

9.4 \tzgetxyval

\tzgetxyval extracts the values of x-coordinate and the y-coordinate *in the unit of centimeter* from a specified coordinate and saves the values in the user-defined macros, so that you can use them later. For example, \tzgetxyval(3,2){\xval}{\yval} results in \xval=3 and \yval=2.

```

% syntax
\tzgetxyval(<coor>){<\macroXval>}{<\macroYval>}
% default
(<m>){<m>}{<m>}

```



```

\begin{tikzpicture}
\tzhelpplines(4,3)
\tzfn"dem"{3-(3/4)*\x}[0:4]
\tzfn"sup"{\x}[0:4]
% intersection point: (E)
\tzXpoint*{dem}{sup}(E)(5pt)
% extract x/y-coordinate from (E)
\tzgetxyval(E){\Ex}{\Ey}
\tzdots*(\Ex,\Ey){E}(\Ex+1,\Ey){F}(\Ex,\Ey+1){G};
\tzdot(E)(10pt)
\tznodeframe(2,0){x\;=\;\Ex\,cm\ y\;=\;\Ey\,cm}
[font=\ttfamily\scriptsize,align=left]
\end{tikzpicture}

```

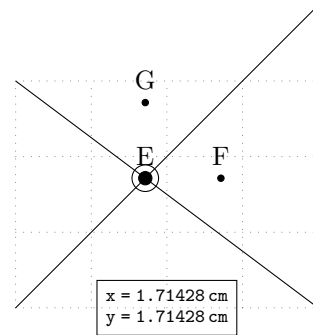

9.5 \tzcoortangenttocircle(*)

\tzcoortangenttocircle finds the *tangent coordinates* to a *node circle* from a point. This works together with \tznodecircle.

The starred version \tzcoortangenttocircle* prints dots (by \tzdot*) at the tangent coordinates.

See Section 11.7 on page 77 for more details.

10 Plot Coordinates: \tzplot: Semicolon Versions

10.1 \tzplot and \tzplot*: Syntax

\tzplot takes an *arbitrary number of coordinates* as arguments. Internally, \tzplot uses the plot coordinates operation of TikZ.

Each (<coord>) can be followed by the optional arguments {<label>} and [<angle>] to label the coordinate. This is a *semicolon version* and the whole repeating pattern is the triple (<coord>){<label>}[<angle>]. It is required to type a semicolon ‘;’ to indicate when the coordinate iteration ends.

The macro \tzplot draws connected line segments that link specified coordinates.

```

% syntax: minimum
\tzplot(<coord>)(<coord>)..repeated..(<coord>) ;
% syntax: medium
\tzplot(<coord>){<label>}[<angle>]..repeated..(<coord>){<label>}[<angle>] ;
% syntax:full
\tzplot[<opt>]{<tension>} [<plot opt>]<shift coord>"<path name>"
(<coord>){<label>}[<label opt>]<angle>]
..repeated..
(){}[] ; (<mark size>) <code.append>
% defaults
[tzmark=2pt]{0}[smooth] <>" (<m>){}[] ..repeated.. (){}[] ; (2pt) <>
- [<plot opt>] is [smooth] by default
- It can be changed to [smooth cycle]

```

The starred version \tzplot* prints dot marks at specified coordinates, without drawing line segments connecting the coordinates, by default.

\tzplot* is equivalent to \tzplot [draw=none,mark=*]. The style tzmark is defined as follows:

```

% style: tzmark
\tikzset{

```

```

tzmark/.style=
  {mark options={solid,thin},mark size=#1},
tzmark/.default=\tzmarksize
}

```

`\tzmarksize` is the *radius* of a mark and the default is 2pt as in *TikZ*. The value of `\tzmarksize` can be changed by the macro `\setztmarksize`, like `\setztmarksize{3pt}`.

10.2 `\tzplot*`: Dots and marks

The starred version `\tzplot*` prints *TikZ* marks (* by default) at specified coordinates. You can change the mark color and mark style using the first bracket optional argument.

```

\tzplot*(0,0)(1,2)(2,2)(3,3); % works like:
\draw [draw=none,mark=*] plot coordinates { (0,0)(1,1)(2,2)(3,3) } ;

```

```

% \tzplot*
\begin{tikzpicture}[scale=.8]
\tzhelplines(4,3)
\tzplot*(0,0)(1,1)(2,1)(3,3);
\tzplot*[mark=o](0,3)(1,3)(2,2)(3,1) ; % semicolon
\tzplot*[red](0,2)(1,2)(2,0)(3,2);
\end{tikzpicture}

```

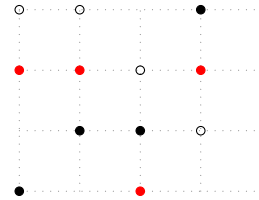

Labels, marks, and mark size You can also add labels to specified coordinates with the optional arguments `{<label>}` and `[<angle>]` immediately after each `(<coord>)`.

```

\tzplot*(0,0){A}[90](1,2)(2,2)(3,3){D}[0]; % works like:
\draw [draw=none,mark=*] plot coordinates { (0,0)(1,1)(2,2)(3,3) }
(0,0) node [label={90:A}] {}
(3,3) node [label={0:D}] {} ;

```

There are THREE WAYS to change the mark size.

1. The simplest way is to use the parenthesis optional argument `(<mark size>)`, *immediately after the semicolon*.
2. You can use the style `tzmark`, like `tzmark=3pt`.
3. You can also use the macro `\setztmarksize`, which is effective until the end of `tikzpicture` environment.

```

% \tzplot*: label, size
\begin{tikzpicture}[scale=.8]
\tzhelplines(4,3)
\tzplot*(0,0){A}[-135](1,1)(2,1)(3,3){D}[[blue]0];(1mm)
\tzplot*[mark=o,tzmark=6pt](0,3)(1,3)(2,2)(3,1);
\setztmarksize{4pt}
\tzplot*[red](0,2){A}(1,2){B}(2,0){C}[[blue]0](3,2){D};
\end{tikzpicture}

```

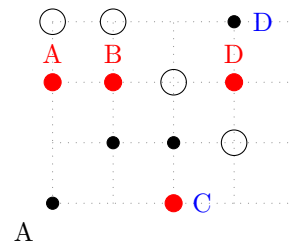

Remark: You can use strings such as `a`, `b`, `ar`, and so on, instead of angles, from the version 2 of the `tzplot` package. These strings are replaced by the corresponding positioning words such as `above`, `below`, `above right`, and so on. (See also Section 2.3.5 on page 5 for more details.)

```

% \tzplot*: label: strings instead of angles
\begin{tikzpicture}[scale=.8]
\zhelplines(4,3)
\tzplot*(0,0){A}[b1](1,1)(2,1)(3,3){D}[[blue]r];(1mm)
\tzplot*[mark=o,tzmark=6pt](0,3)(1,3)(2,2)(3,1);
\settzmarksiz{4pt}
\tzplot*[red](0,2){A}(1,2){B}(2,0){C}[[blue]r](3,2){D};
\end{tikzpicture}

```

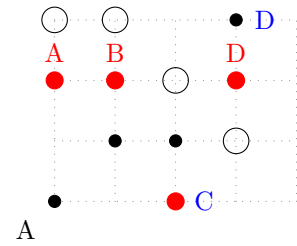

With `\tzplot*`, you can draw line segments by giving the TikZ's option `draw` in the first bracket optional argument, like `\tzplot*[draw]`.

```

% \tzplot*: line, more marks, size
\begin{tikzpicture}[scale=1]
\zhelplines(4,3)
\settzmarksiz{3pt}
\tzplot*[draw,mark=x]
(0,0)(1,1)(2,1)(3,3);
\tzplot*[blue,mark=diamond*]
(0,3)(1,3)(2,2)(3,1);(10pt)
\tzplot*[draw,dashed,red,mark=heart]
(0,2)(1,2)(2,0)(3,2);
\end{tikzpicture}

```

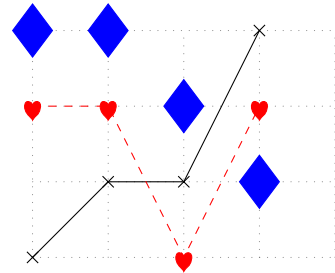

Remark: In TikZ, the mark shapes are affected by `scale`, `xscale`, and `yscale`.

```

% \tzplot*: marks: distorted
\begin{tikzpicture}[yscale=.5]
\zhelplines(4,3)
\settzmarksiz{3pt}
\tzplot*[draw,mark=x]
(0,0)(1,1)(2,1)(3,3);
\tzplot*[blue,mark=diamond*]
(0,3)(1,3)(2,2)(3,1);(10pt)
\tzplot*[draw,dashed,red,mark=heart]
(0,2)(1,2)(2,0)(3,2);
\end{tikzpicture}

```

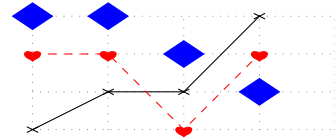

Shift You can move specified coordinates using the option `<shift> <coord>` before the first coordinate (to be precise, immediately before the option `"<path name>"` if it exists). The *empty* shift option `<>` is *not allowed*.

```

% \tzplot*: shift
\begin{tikzpicture}
\zhelplines(4,3)
\tzcoors(1,3)(A)(2,3)(B)(3,3)(C)(4,3)(D);
\tzplot*[draw](A){A}(B)(C)(D){D}[0];
\tzplot*[draw,red]<-1,-1>(A){A}(B)(C)(D){D}[0];
\tzplot*[draw,blue]<0,-3>(A){A}(B)(C)(D){D}[0];
\end{tikzpicture}

```

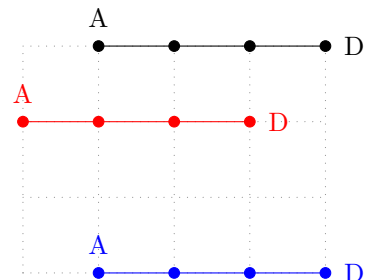

Extending path You can use `<code.append>` as the last optional argument after a semicolon.

```

\begin{tikzpicture}
\tzhelplines(4,3)
\tzplot*[draw](0,0)(1,1)(2,2){C}(3,2){D};
< arc (-90:0:1cm) node [a] {ends here!}>
\end{tikzpicture}

```

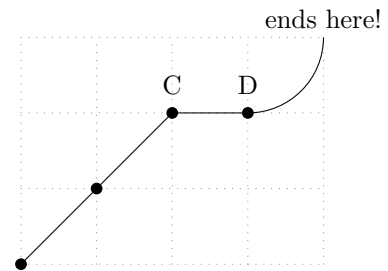

`\tzplotAtBegin` and `\tzplotAtEnd` are also available. These work with `\tzplot*[draw]` and `\tzplot` to extend the paths at the beginning and at the end, respectively. Specifying `<code.append>` extends the path after `\tzplotAtEnd`.

```

\begin{tikzpicture}
\tzhelplines(4,3)
\tzplotAtBegin{(0,2) to [bend right]} % ERROR!!!
\tzplotAtEnd{arc (90:0:1cm) node [b] {here?}}
\tzplot*[draw,blue](0,0)(1,1)(2,2){C}(3,2){D};
<arc (-90:0:1cm) node [r] {ends here!}>
\tzplot*[draw,red]<.5,1>(0,0)(1,1)(2,2){C}(3,2){D};
<arc (-90:0:1cm) node [r] {ends here!}>
\end{tikzpicture}

```

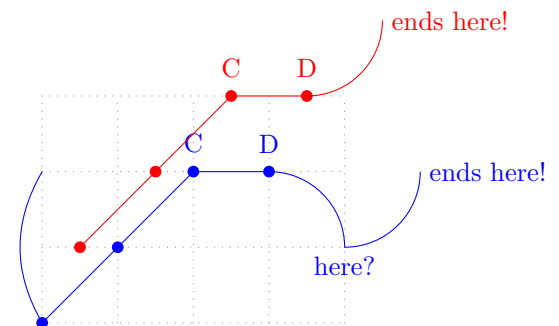

10.3 `\tzplot`: Lines

`\tzplot` draws connected line segments connecting specified coordinates. (By default, `tension=0`.)

```

\tzplot(0,0)(1,2)(2,2)(3,3); % works like:
\draw [tension=0] plot [smooth] coordinates { (0,0)(1,1)(2,2)(3,3) };

```

`\tzplot*` is equivalent to `\tzplot[draw=none,mark=*]`.

Options: draw, mark, mark options, etc. You can use the optional argument [`<opt>`] to change the style of lines and marks.

```

% \tzplot: line
\begin{tikzpicture}[scale=.8]
\tzhelplines(4,3)
\tzplot      (0,0)(1,1)(2,1)(3,3);
\tzplot[dashed,mark=o](0,3)(1,3)(2,2)(3,1);
\tzplot[red,mark=ball,mark options={ball color=purple}]
(0,1)(1,2)(2,0)(3,2);
\end{tikzpicture}

```

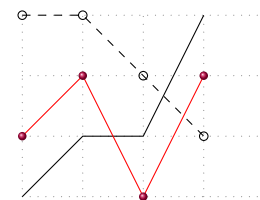

To close the path of `\tzplot` you can use the option `smooth cycle` in the first bracket optional argument [`<opt>`] or in the second bracket optional argument [`<plot opt>`].

```

% \tzplot: smooth cycle
\begin{tikzpicture}[scale=.8]
\tzhelplines(4,3)
\tzplot      (0,0)(1,1)(2,1)(3,3);
\tzplot[dashed,mark=o,smooth cycle]
      (0,3)(1,3)(2,2)(3,1);
\tzplot[red,mark=*,mark options={blue}]
      [smooth cycle] %% default tension=0
      (0,1)(1,2)(2,0)(3,2);
\end{tikzpicture}

```

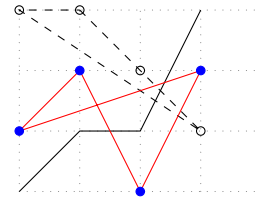

Labels You can label specified coordinates with the options {<label>} and [<angle>] immediately after each (<coord>).

```

% \tzplot: label
\begin{tikzpicture}[scale=.8]
\tzhelplines(4,3)
\tzplot(0,0){A}(1,1){B}[-90](2,1)(3,3){Da}[[draw]0];
\tzplot[mark=o](0,3)(1,3){B}(2,2)(3,1){Db}[0];
\tzplot[red,mark=*,draw=blue]
      (0,1)(1,2){B}(2,0)(3,2){Dc}[[blue]0];
\end{tikzpicture}

```

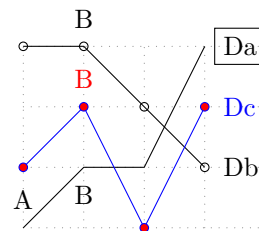

Shift You can also move the line segments by specifying the option <shift coord> before the first coordinate (to be precise, immediately before the option "<path name>" if it exists). The *empty* shift option <> is *not allowed*.

```

% \tzplot: shift
\begin{tikzpicture}[scale=.8]
\tzhelplines(4,3)
\tzcoors(0,0)(A)(1,1)(B)(2,1)(C)(3,3)(D);
\tzplot      <1,0>(A)(B)(C)(D){Da}[0];
\tzplot[mark=o] <1,0>(0,3)(1,3)(2,2)(3,1){Db}[0];
\tzplot*[draw,red]<1,0>(0,1)(1,2)(2,0)(3,2){Dc}[0];
\end{tikzpicture}

```

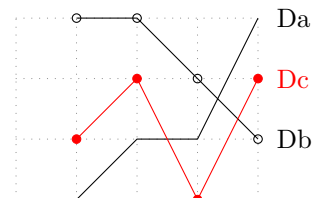

name path for intersections To find the intersection points of two lines, you may want to name the paths first, like [name path=<path name>] in TikZ. With \tzplot, you can do it by specifying the quote optional argument "<path name>" immediately before the first coordinate.

```

% \tzplot: "path name"
\begin{tikzpicture}[scale=.8]
\tzhelplines(4,3)
\tzplot[name path=Da] (0,0)(1,1)(2,1)(3,3){Da}[0];
\tzplot[mark=o] "Db"(0,3)(1,3)(2,2)(3,1){Db}[0];
\tzplot*[draw,red]"Dc"(0,1)(1,2)(2,0)(3,2){Dc}[0];
% intersection points
\tzXpoint*[gray]{Da}{Db}
\tzXpoint*[blue]{Da}{Dc}
\end{tikzpicture}

```

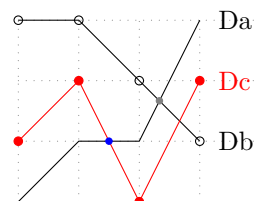

Extending the path In order to *extend a path*, formed by `\tzplot`, from the last coordinate, you can write TikZ code in the very last optional argument `<code.append>`, after the semicolon.

```
% \tzplot: "path name"
\begin{tikzpicture}[scale=.8]
\tzhelplines(6,4)
\tzplot(0,0)(1,1)(2,1)(3,3){Da}[0];< -- (6,4) >
\tzplot[mark=o](0,3)(1,3)(2,2)(3,1){Db}[0];(4pt)
\tzplot[mark=ball,red](0,1)(1,2)(2,0)(3,2){Dc}[0];
(5pt)< to [bend left] ++(2,-2) node {ends here!} >
\end{tikzpicture}
```

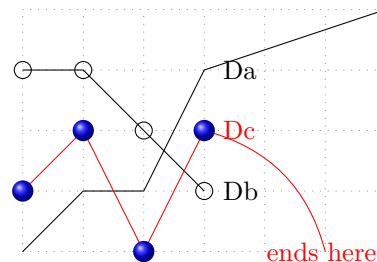

You can also use `\tzplotAtBegin` and `\tzplotAtEnd` to extend the path of `\tzplot` at the beginning and at end, respectively. Specifying `<code.append>` extends the path after `\tzplotAtEnd`.

10.4 \tzplot: Curves

With `\tzplot`, the default value of `tension` is 0. You can draw a curve with `\tzplot`, by specifying the optional argument `{<tension>}` before the coordinates or between the first and second bracket options (if they exist).

```
\tzplot[blue,smooth cycle]{1}(0,0)(1,2)(2,2)(3,3); % works like:
\draw [blue,tension=1] plot [smooth cycle] coordinates { (0,0)(1,1)(2,2)(3,3) } ;
```

```
\begin{tikzpicture}[scale=.8]
\tzhelplines(4,3)
\tzplot[tension=1](0,0)(1,1)(2,1)(3,3);
\tzplot[mark=o](0,3)(1,3)(2,2)(3,1); % tension=0
\tzplot*[draw,red,smooth cycle]{1} % tension=1
(0,1)(1,2)(2,0)(3,2);
\end{tikzpicture}
```

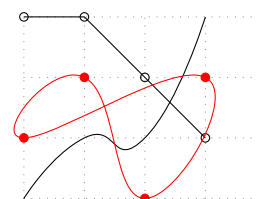

To plot curves, the macro `\tzplotcurve` is provided. Basically, `\tzplotcurve` is the `tension=1` version of `\tzplot`. (See Section 10.6 on page 64.)

10.5 \tzplot: Bars and combs

With `\tzplot`, you can draw bars or combs, using the TikZ options `ybar`, `xbar`, `ycomb`, and `xcomb`.

```
\begin{tikzpicture}[scale=.8]
\tzhelplines(4,3)
\tzplot*[draw](0,0)(1,1)(2,1)(3,3);
\tzplot[ybar](0,3)(1,3)(2,2)(3,1);
\tzplot[dashed,red,mark=heart](0,1)(1,2)(2,0)(3,2);
\end{tikzpicture}
```

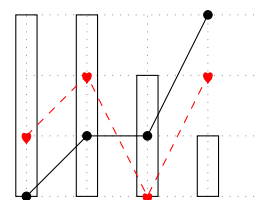

```
\begin{tikzpicture}[scale=.8]
\tzhelplines(4,3)
\tzplot[xbar](.5,2.5)(1,3)(2,2)(3,1);
\tzplot[xbar,bar width=2mm,fill,red!50]
(1,2.5)(1.5,2)(2,0)(3,1.5);(3pt)
\end{tikzpicture}
```

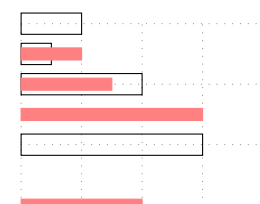

```

\begin{tikzpicture}[yscale=1.5]
\tzhelplines(0,-1)(4,1)
\tzplot[ycomb,mark=*,very thick,blue]
(.5,.1)(1,.3)(1.5,.4)(2,.5)
(4,-.1)(3.5,-.3)(3,-.4)(2.5,-.5);
\end{tikzpicture}

```

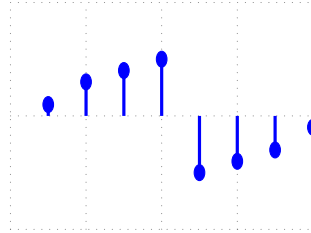

```

\begin{tikzpicture}[scale=.8]
\tzhelplines(4,3)
\tzplot[xcomb,mark=*,very thick]
(1,2.5)(1.5,2)(2,0)(3,1.5);
\end{tikzpicture}

```

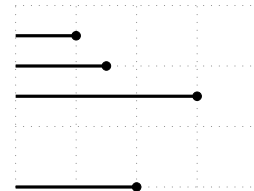

Remark:

- Do not use `<shift coor>` for plotting bars or combs to avoid getting unexpected results. It gives you wrong bars because `<shift coor>` moves coordinates but not bars.
- It can be a mess when using the TikZ option `shift={ (coor) }` with the type of *mixed* coordinates: *native* and *named* coordinates.

10.6 \tzplotcurve(*)

`\tzplotcurve` draws a curve connecting specified coordinates with `tension=1`, by default. Basically, it is equivalent to `\tzplot` with `[tension=1]`.

The starred version `\tzplotcurve*` draws a curve and displays marks `*`, by default. Basically, this is equivalent to `\tzplot*[draw,tension=1]`.

```

% syntax: minimum
\tzplotcurve(<coor>)(<coor>)..repeated..(<coor>);
% syntax: full
\tzplotcurve* [<opt>] [<tension>] [<plot opt>] <shift coor> "<path name>"
(<coor>){<label>} [<label opt>] <angle>
..repeated..
(){}[]; (<mark size>) <code.append>
% defaults
*[tzmark=2pt]{1}[smooth] <>" (<m>){}[] ..repeated.. (){}[]; (2pt) <>

```

```

\tzplotcurve(0,0)(1,2)(2,2)(3,3); % works like:
\draw [tension=1] plot [smooth] coordinates { (0,0)(1,1)(2,2)(3,3) };

```

```

\tzplotcurve[blue,smooth cycle]{2}(0,0)(1,2)(2,2)(3,3); % works like:
\draw [blue,tension=2] plot [smooth cycle] coordinates { (0,0)(1,1)(2,2)(3,3) };

```

Since `\tzplotcurve` is a *semicolon version*, you need to enter a semicolon to indicate when the coordinate iteration ends. In repeating coordinates, each mandatory coordinate can have a label. So the whole repeating pattern is the triple `(<coor>){<text>} [<pos>]`. For example, `(A){here}[above]` represents (A) node [above] {here} in TikZ.

Options: lines, labels, colors, smooth cycle Use the first bracket option to control the colors of lines or labels.

```

\tzplotcurve(0,0)(1,2)(2,2){A}[below](3,3){B}[right]; % works like:
\draw [tension=1] plot [smooth] coordinates { (0,0)(1,1)(2,2)(3,3) }
(2,2) node [below] {A}
(3,3) node [right] {B} ;

```

You can change the color of all labels together by adding `[text=<color>]` to the first bracket option list.

```

% \tzplotcurve(*)
\begin{tikzpicture}
\tzhelplines(4,3)
\tzplotcurve*[red,text=blue]
(0,0)(1,2){B}(2,2)(3,3)(4,1){E}[0];
\tzplotcurve(1,.5)(2,3)(3,2)(2,1)(3,1);
\end{tikzpicture}

```

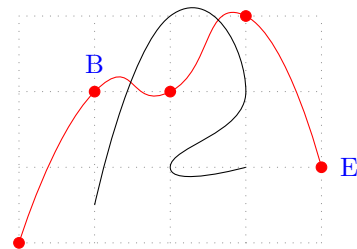

The simplest way to change the mark size is to specify `<mark size>` immediately after the semicolon `;`. To close the path of `\tzplotcurve`, you can use the TikZ option `smooth cycle` in the first bracket option or in the second bracket option.

```

% \tzplotcurve(*): smooth cycle, mark size
\begin{tikzpicture}
\tzhelplines(4,3)
\tzplotcurve*[red,text=blue][smooth cycle]
(0,0)(1,2){B}(2,2)(3,3)(4,1){E}[0];(3pt) %%
\tzplotcurve*[smooth cycle](1,.5)(2,3)(3,2)(2,1)(3,1);
\end{tikzpicture}

```

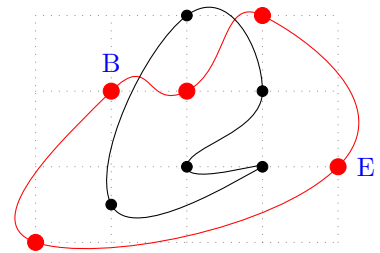

```

% abridges strings: label position
\begin{tikzpicture}
\tzhelplines(4,3)
\tzplotcurve*[red,text=blue][smooth cycle]
(0,0)(1,2){B}[[red]1](2,2)(3,3)(4,1){E}
↔ [[draw]r];(3pt)
\tzplotcurve*[smooth cycle](1,.5)(2,3)(3,2)(2,1)(3,1);
\end{tikzpicture}

```

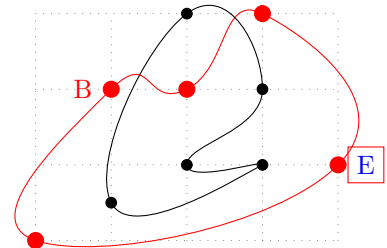

Tension You can change the value of `tension` (`tension=1` by default) by specifying the option `<tension>` before the coordinates or between the two bracket options if they exist.

```

% \tzplotcurve: tension
\begin{tikzpicture}
\tzhelplines(4,3)
\tzcoor(.5,.5)(A)
\tzplotcurve[blue]{2}(1,3)(A)(4,0);
\tzplotcurve[thick](1,3)(A)(4,0); % default: tension=1
\tzplotcurve[red]{.5}(1,3)(A)(4,0);
\tzplotcurve[dashed]{0}(1,3)(A)(4,0);
\end{tikzpicture}

```

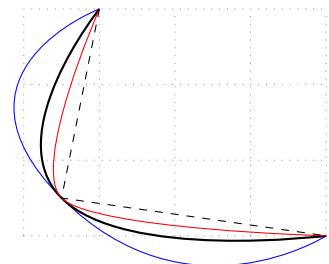

Shift Use the optional argument `<shift coor>` before the first coordinate (to be precise, immediately before "`<path name>`", if it exists). The empty shift option `<>` is not allowed.

```

% \tzplotcurve(*): shift
\begin{tikzpicture}
\tzhelplines(4,3)
\tzcoors(0,0)(A)(1,2)(B)(2,2)(C)(3,3)(D)(4,1)(E);
\tzplotcurve*[red,text=blue,smooth cycle]
<0,1>(A)(B){B}(C)(D)(E){E}[0];(3pt) %%
\tzplotcurve*[smooth cycle]
(1,.5)(2,3)(3,2)(2,1)(3,1);
\end{tikzpicture}

```

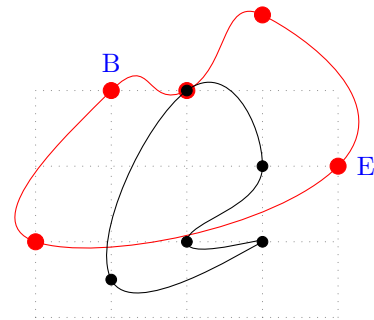

Extending the path In order to extend the path created by `\tzplotcurve(*)` from the last coordinate, you can directly write TikZ code in the very last optional argument `<code.append>`, after the semicolon.

```

% \tzplotcurve(*): <code.append>
\begin{tikzpicture}
\tzhelplines(4,3)
\tzplotcurve*[red,text=blue,thick]
(0,0)(1,2){B}(2,2)(3,3)(4,1){E}[-45];(3pt)
< arc (-90:90:1cm) node [above] {up} > %%
\tzplotcurve[dashed]
(1,.5)(2,3)(3,2)(2,1)(3,1);
< -- ++(-1,-1) node [below] {down} > %%
\end{tikzpicture}

```

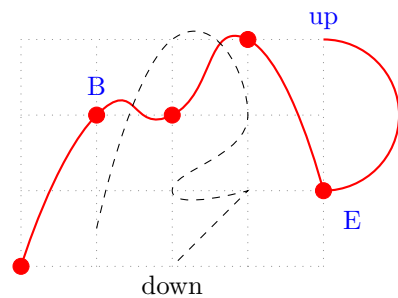

You can also use `<--cycle>` to *close* the path *with a straight line* from the last coordinate to the first coordinate.

```

% \tzplotcurve(*): <--cycle>
\begin{tikzpicture}
\tzhelplines(4,3)
\tzplotcurve*[red,text=blue]
(0,0)(1,2)(2,2)(3,3)(4,1){A}[right] ; (3pt)<--cycle>
\tzplotcurve
(1,.5)(2,3)(3,2)(2,1)(3,1) ; <--cycle>
\end{tikzpicture}

```

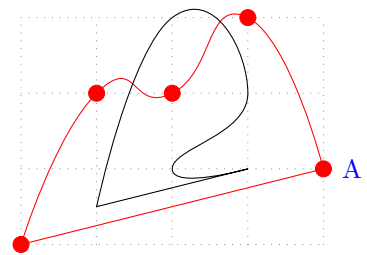

You can also use `\tzplotcurveAtBegin` and `\tzplotcurveAtEnd` to extend the path of `\tzplotcurve` at the beginning and at the end, respectively. Specifying `<code.append>` extends the path after `\tzplotcurveAtEnd`.

```

% \tzplotcurve(*)
\begin{tikzpicture}
\tzhelplines(4,3)
\tzplotcurve*[red,text=blue]
(0,0)(1,2){B}(2,2)(3,3)(4,1){E}[0];
\tzplotcurveAtBegin{(0,2) |-} % ERROR!!!
\tzplotcurveAtEnd{arc (180:270:1cm) node {End!}}
\tzplotcurve(1,.5)(2,3)(3,2)(2,1)(3,1);
\end{tikzpicture}

```

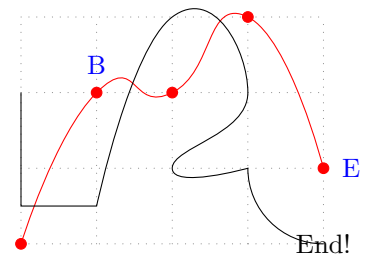

name path for intersection points You can name the path of `\tzplotcurve` by specifying the option "`<path name>`" immediately before the first coordinate.

```

% \tzplotcurve(*): name path
\begin{tikzpicture}
\tzhelplines(4,3)
\tzplotcurve[blue]
"IC"(.5,3)(1.5,1.2)(4,.5){$u$}[0];
\tzplot[draw=red]
"bgt"(0,3)(4,0){budget}[-90];
% intersection points
\tzXpoint{IC}{bgt}(K)
\tzdots*(K){$A_1$}[30](K-2){$A_2$};
\end{tikzpicture}

```

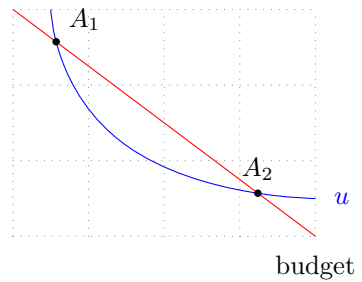

11 Nodes

11.1 \tznode and \tznode*

The macro `\tznode` allows you to put *text* at a specified *coordinate*. `\tznode` expects two mandatory arguments: `<coord>` and `<text>`. You can also *optionally* name a node so that you can refer to the *node coordinate* later.

The starred version `\tznode*` is equivalent to `\tznode[draw]`, which draws the perimeter of the specified node. The default node shape is a **rectangle**.

```

% syntax: minimal
\tznode(<coord>){<text>}
% syntax: full
\tznode[<opt>]<shift coord>(<coord>)(<node name>){<text>}[<node opt>]<node.code>
% defaults: two mandatory arguments
[]<>(<m>){}<>

```

```

\tznode(0,0){text} % works like:
\path (0,0) node {text};
% or
\node at (0,0) {text};

```

```

\tznode[draw] (0,0)(A){text}[above right] % works like:
\node [draw] (A) at (0,0) [above right] {text};

```

`\tznode*` prints the perimeter of a node, which is a **rectangle** by default.

```

% syntax: minimal
\tznode*(<coord>){<text>}
% syntax: full
\tznode*[<opt>]<shift coord>(<coord>)(<name>){<text>}[<node opt>]<node.code>
% defaults
*[draw]<>(<m>){}<>

```

```
\tznode* (0,0)(A){text}[above right] % works like:
\node [draw] (A) at (0,0) [above right] {text};
```

Putting text You can use TikZ options in the first bracket optional argument [*<opt>*] or the second bracket option [*<node opt>*] to put text with different colors, fonts, and so on.

```
% \tznode(*)
\begin{tikzpicture}
\tzhelplines(4,3)
\tznode(1,1){text}
\tznode(2,2){another\text}[align=left]
\tznode*(3,1){\textbf{text}}
\tznode*[blue](3,0){\scshape Text}[r] % right
\tznode*(4,2){another\text}
  \to [align=center,font=\itshape]
\end{tikzpicture}
```

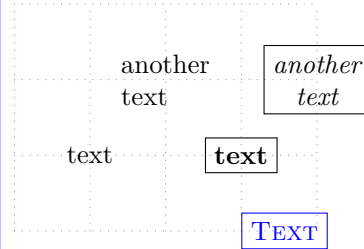

Abbreviations You can use *abbreviations* (or aliases) such as *a* for above, *l* for left, *ar* for above right, *bl* for below left, and so on to indicate where the *text* of a *main node* is placed. (See also Section 1.2 on page 2.)

Remark:

- A *label node* is placed by angles or the corresponding positioning words.
- A *main node* is placed by the placement words or their aliases.
- You cannot use angles to place main nodes.

```
% \tznode(*): main node, label node
\begin{tikzpicture}
\tzhelplines(4,3)
\tzdot*(1,1)
\tznode*(1,1){A}[ar]
\tznode*[red](1,1){B}[b]
\tznode(1,1){C}[l]
\tznode*[inner sep=0pt,text=blue,scale=2]
  (3,2){Text}[label=180:Left,pin=45:Above Right]
\tznode*[inner sep=0pt,text=red,scale=2]
  (3,2){Text}[b=2cm] %% below=2cm
\end{tikzpicture}
```

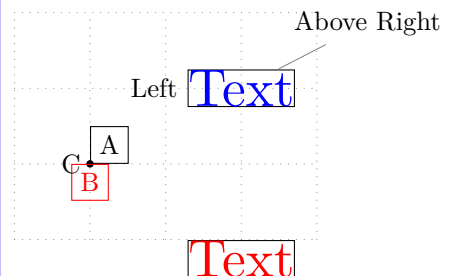

Naming nodes You can name a node at a specified coordinate (*<coord>*) by specifying (*<name>*) immediately after the coordinate. You can use the node name as a *node coordinate*.

```
% \tznode(*): name nodes
\begin{tikzpicture}
\tzhelplines(4,3)
\tznode*(1,1)(A){A}
\tznode*[fill=blue,text=yellow](2,3)(B){B}
\tznode*[circle,text=red](4,1)(C){C}
\tzline[->](A)(B)
\tzto[->,bend left,dashed](B)(C)
\end{tikzpicture}
```

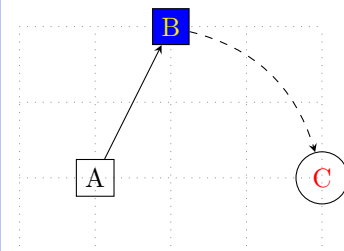

Shift You can move the coordinates by specifying the option `<shift coor>` immediately before the coordinate (`<coor>`). The empty shift option `<>` is not allowed.

```
% \tznode(*): shift
\begin{tikzpicture}
\tzhelplines(4,3)
\tznode* <-1,0>(1,1) (A){A}
\tznode*[fill=blue,text=yellow] <1,-1>(2,3) (B){B}
\tznode*[circle,text=red] <-2,-1>(4,1) (C){C}
\tzline[->] (A) (B)
\tzto[->,bend left,dashed] (B) (C)
\end{tikzpicture}
```

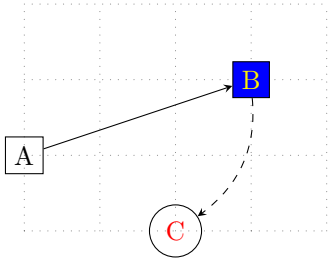

Repetition: foreach The *last* optional argument `<node.code>` can be used to iterate over to place multiple nodes.

```
% \tznode(*): foreach, shift
\begin{tikzpicture}
\tzhelplines(4,3)
\tznode(\x,0){\x}
  < foreach \x in {1,2,3} >
\tznode* <1,2>(\x,0){\x}[circle,blue,fill=yellow]
  < foreach \x in {1,2,3} >
\end{tikzpicture}
```

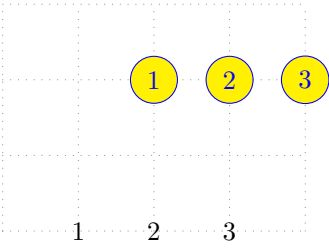

```
\tznode(\x,0){\x}<foreach \x in {1,2,3}> % works like
  \node foreach \x in {1,2,3} at (\x,0) {\x};
```

```
% \tznode: foreach
\begin{tikzpicture}
\tzhelplines(4,3)
\tznode(\x,\y){$P_{\x\y}$}
  < foreach \x in {1,2,3,4}
    foreach \y in {1,2,3} >
\end{tikzpicture}
```

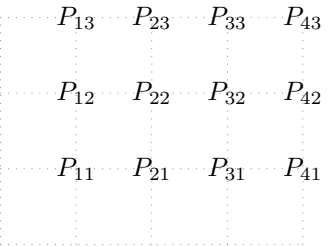

11.2 \tznodes and \tznodes*: Semicolon versions

`\tznodes` accepts any number of *mandatory* pairs of coordinates and their names to defined node coordinates at specified coordinates.

```
% syntax: minimum
\tznodes(<coor>)(<node name>)..repeated..(<coor>)(<node name>) ;
% syntax: medimum
\tznodes(<coor>)(<node name>){<text>}[<node opt>]..repeated..(){}[] ;
% syntax: full
\tznodes[<every node opt>]<shift coor>
  (<coor>)(<node name>){<text>}[<node opt>]..repeated..(){}[] ;
% defaults
[] <> (<m>)(<m>){}[] ..repeated..(){}[] ;
*[draw]<> (<m>)(<m>){}[] ..repeated..(){}[] ;
```

Each pair of a coordinate and a node coordinate name can be followed by the optional arguments {<text>} and [<node opt>] to print node text. Since this is a semicolon version, it is required to type a semicolon ; to indicate when the repetition ends. \tznodes works similarly to \tzcoors, but the former uses main nodes and the latter uses label nodes.

The starred version \tznodes* is equivalent to \tznodes[draw]. That is, all node perimeters are drawn.

```

% \tznodes
\begin{tikzpicture}
\tzhelplines(4,3)
\tznodes(0,0)(A){A}
      (1,1)(B){B}
      (2,1)(C){C}[r]
      (3,2)(D){D}[b]
      (4,0)(E){E};           % semicolon
\tzlines(A)(B)(C)(D)(E);
\end{tikzpicture}

```

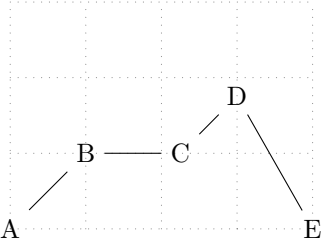

```

% syntax: minimum
\tznodes(<coord>(<node name>)..repeated..(<coord>(<node name>);
% syntax: medimum
\tznodes(<coord>(<node name>){<text>}[<node opt>]..repeated..(){}[];
% syntax: full
\tznodes[<every node opt>]<shift coord>
      (<coord>(<node name>){<text>}[<node opt>]..repeated..(){}[];
% defaults
[] <> (<m>(<m>){}[]..repeated..(){}[];
*[draw]<> (<m>(<m>){}[]..repeated..(){}[];

```

```

% \tznodes*: rectangle nodes (default)
\begin{tikzpicture}
\tzhelplines(4,3)
\tznodes*(0,0)(A){A}
      (1,1)(B){B}
      (2,1)(C){C}[r]
      (3,2)(D){D}[b]
      (4,0)(E){E};           % semicolon
\tzlines(A)(B)(C)(D)(E);
\end{tikzpicture}

```

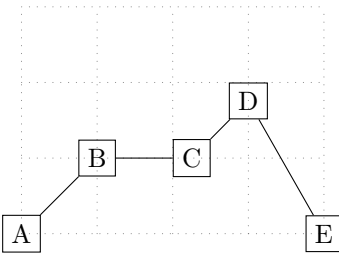

```

% \tznodes*: ellipse nodes
\begin{tikzpicture}
\tzhelplines*(5,4)
\tznodes*[ellipse,fill=yellow,text=blue]
      (0,0)(A){Ann}
      (1,1)(B){Bryn}
      (2,0)(C){C}[r]
      (3,2)(D){Donald}[b,font=\scshape]
      (4,0)(E){End!}[rectangle,fill=green];
\tzlines(A)(B)(C)(D)(E);
\end{tikzpicture}

```

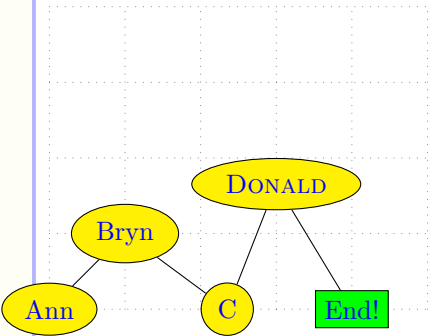

```

% \tznodes: shift
\begin{tikzpicture}
\tzhelplices*(5,4)
\tznodes*[ellipse,fill=yellow,text=blue]
  <1,1>(0,0)(A){Ann}
  (1,1)(B){Bryn}
  (2,0)(C){C}[r]
  (3,2)(D){Donald}[b,font=\scshape]
  (4,0)(E){End!}[rectangle,fill=green];
\tzlines(A)(B)(C)(D)(E);
\end{tikzpicture}

```

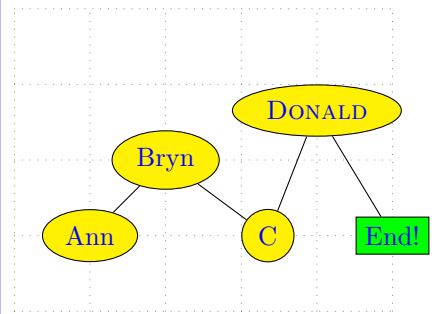

11.3 \tznodedot(*)

\tznodedot names a node and prints a circle node dot (of the size 2.4pt, by default). \tznodedot is basically the same as \tздot, except for one thing. \tznodedot names a node.

The starred version \tznodedot* prints a filled circle node dot (of the size 2.4pt, by default), just like \tздot*. But it *optionally* names a node.

```

% syntax: medium
\tznodedot(<coord>)(<node name>){<label>}[<angle>]
% syntax: full
\tznodedot* [<opt>] <shift coord>
  (<coord>)(<node name>){<label>}[<[label opt]angle>] (<dot size>)
% defaults
[tздot] <>(<m>){}[] (2.4pt)
*[tздot,fill] <>(<m>){}[] (2.4pt)

```

Since \tznodedot(*) prints a node dot, its <label> is placed by <angle>.

```

\tznodedot*(1,1)(A){Ace}[180] % works like:
\path (1,1) node (A) [tздot,fill,label={180:Ace}] {};

```

```

% \tznodedot(*): label, color
\begin{tikzpicture}
\tzhelplices(4,3)
\tznodedot(0,0)
\tznodedot(1,1)(A){A}[180]
\tznodedot*(2,3)(B){\textbf{B}}
\tznodedot[rectangle](4,1)(C){C}[[red]0]
\tzline[->](A)(B)
\tzto[->,bend left,dashed](B)(C)
\end{tikzpicture}

```

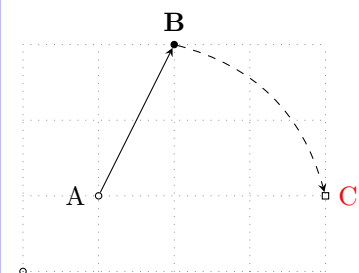

You can apply the THREE WAYS (on page 46) to change the size of node dots. The simplest way is to use the last parenthesis option (<dot size>).

```

% \tznodedot(*): size
\begin{tikzpicture}
\tzhelplines(4,3)
\settzdotsize{5pt} %%
\tznodedot(1,1)(A){A}[180]
\tznodedot*(2,3)(B){B}
\tznodedot[rectangle](4,1)(C){C}[0](10pt) %%
\tzline[->](A)(B)
\tzto[->,bend left,dashed](B)(C)
\end{tikzpicture}

```

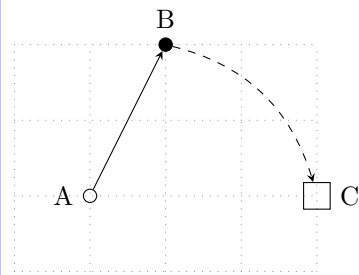

You can move the coordinates of dots by specifying the `<shift coord>` option immediately before the coordinate. The empty shift option `<>` is not allowed.

```

% \tznodedot(*): shift
\begin{tikzpicture}
\tzhelplines(4,3)
\settzdotsize{5pt}
\tznodedot(1,1)(A){A}[180]
\tznodedot*(2,3)(B){B}
\tznodedot[rectangle]<-1,-1>(4,1)(C){C}[0](10pt) %%
\tzline[->](A)(B)
\tzto[->,bend left,dashed](B)(C)
\end{tikzpicture}

```

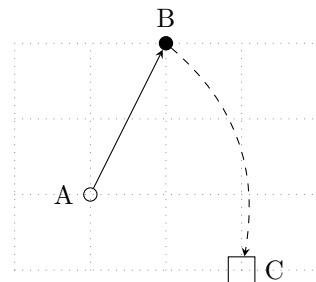

You can use the abridged strings instead of angles. (See also Section 2.3.5 on page 5.)

```

% abridged strings: label position
\begin{tikzpicture}
\tzhelplines(4,3)
\settzdotsize{5pt}
\tznodedot(1,1)(A){A}[[draw,blue]1]
\tznodedot*(2,3)(B){B}
\tznodedot[rectangle]<-1,-1>(4,1)(C){C}[br](10pt) %%
\tzline[->](A)(B)
\tzto[->,bend left,dashed](B)(C)
\end{tikzpicture}

```

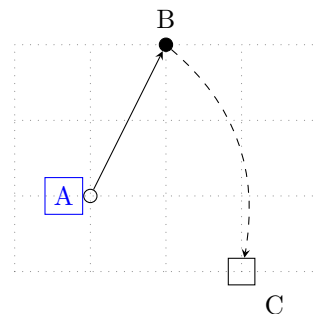

11.4 \tznodedots(*): Semicolon versions

`\tznodedots` accepts any number of *mandatory* pairs of coordinates and their names to print multiple node circle dots at specified coordinates. It works just like `\tzdots`, for one exception. It names multiple node coordinates. Everything else is the same as in `\tzdots`.

The starred version `\tznodedots*` prints filled node circle dots.

```

% syntax: minimum
\tznodedots(<coord>(<node name>)..repeated..(<coord>(<node name>)) ;
% syntax: full
\tznodedots[<dot opt>]<shift coord>
    (<coord>(<node name>){<label>}[<label opt>angle]
    ..repeated.. ()(){}[] ; (<dot size>)
% defaults
[tzdot=2.4pt] <> (<m>(<m>){}[] ..repeated.. ()(){}[] ; (2.4pt)
*[tzdot=2.4pt,fill] <> (<m>(<m>){}[] ..repeated.. ()(){}[] ; (2.4pt)

```

```

% \tznodedots: label
\begin{tikzpicture}
\tzhelplines(4,3)
\tznodedots(0,0) (A){A}
(1,1) (B)
(2,1) (C){C}[0]
(3,2) (D){D}[-90]
(4,0) (E){E} ; % semicolon
\tzlines[red] (A) (B) (C) (D) (E);
\tznodedots*
(0,3) (A) (1,2) (B) {B} (2,2) (C) {C} [45] (3,3) (D) (4,3) (E);
\tzlines(A) (B) (C) (D) (E);
\end{tikzpicture}

```

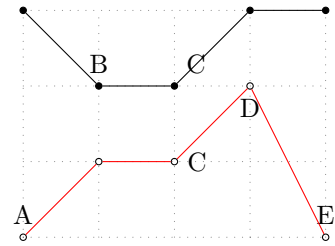

The simple first bracket option of `\tznodedots(*)` controls dots rather than labels. If you want to control all the labels, you can use TikZ's `every label` style as follows:

```

% every label/.style
\begin{tikzpicture}
\tzhelplines(4,3)
\begin{scope}[every label/.style={draw,text=red}]
\tznodedots*[green]
(0,0) (Ace){Ace} [[font=\LARGE\ttfamily]-90]
(2,1) (Bob){\textbf{Bob}} [[blue]135]
(3,2) (Cate){$C_1$\\$N_o$} [[align=center]0]
(4,0) (D){Done!}; (5pt)
\end{scope}
\end{tikzpicture}

```

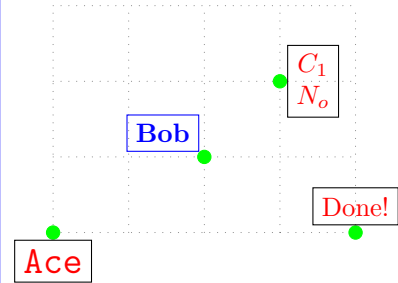

Remark: Comparison of connecting nodes and coordinates:

```

% connecting \tznodedots
\begin{tikzpicture}
\tzhelplines(4,3)
\tznodedots(0,0) (A){A}
(1,1) (B)
(2,1) (C){C} [[red]-90]
(3,2) (D){D} [[draw,blue]a]
(4,0) (E){E}; (6pt)
\tzlines[thick] (A) (B) (C) (D) (E); % connects nodes
\end{tikzpicture}

```

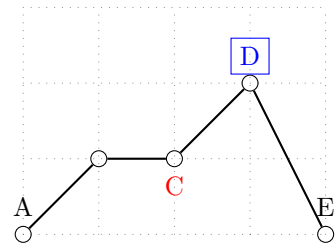

While the previous example shows that `\tzlines` connects nodes, the following example shows that `\tzlines` connects coordinates.

```

% connecting \tzcoors
\begin{tikzpicture}
\tzhelplines(4,3)
\tzcoors*[fill=None] (0,0) (A){A}
(1,1) (B)
(2,1) (C){C} [[red]-90]
(3,2) (D){D} [[draw,blue]a]
(4,0) (E){E}; (6pt)
\tzlines[thick] (A) (B) (C) (D) (E); % connects coordinates
\end{tikzpicture}

```

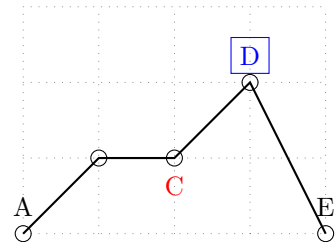

11.5 \tznodeframe and \tznodeframe*

\tznodeframe draws and *optionally* names a rectangle node with (black, by default) text in it.

```
% syntax:
\tznodeframe[<opt>](<coor>)(<node name>){<text>}[<node opt>]
% defaults
[draw]<>(<m>){}[text=black]
```

```
\tznodeframe(2,1)(A){Here}[a] % works like
\node [draw,rectangle] (A) at (2,1) [above] {Here} ;
```

```
% \tznodeframe
\begin{tikzpicture}
\tzhelplines(4,3)
\tznodeframe(0,0)(A)
\tznodeframe(4,2)(B)[circle]
\tzline[blue,thick](A)(B)
\tznodeframe[scale=1.5](2,1){Node frame}
[label=180:Left, pin=-45:pin]
\end{tikzpicture}
```

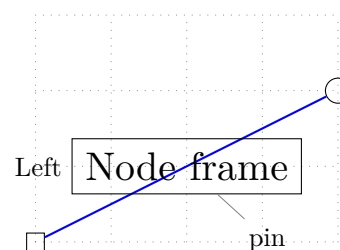

```
% \tznodeframe: fill (opacity=1)
\begin{tikzpicture}
\tzhelplines(4,3)
\tznodeframe(0,3)
\tznodeframe(0,0)(A)
\tznodeframe(4,2)(B)[circle]
\tzline[blue,thick](A)(B)
\tznodeframe[fill=green,scale=1.5](2,1){Node frame}
[label=180:Left, pin=-45:pin]
\end{tikzpicture}
```

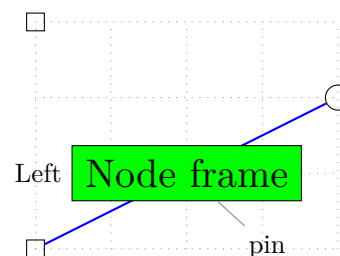

The starred version \tznodeframe* fills the rectangle with color (black!50 by default) with fill opacity=.3 and text opacity=1, by default.

```
% syntax:
\tznodeframe*[<opt>]<shift coor>
(<coor>)(<node name>){<text>}[<node opt>]{<fill opacity>}
% defaults
*[fill=black!50,fill opacity=.3,text opacity=1] <>
(<m>){}[draw=black,text=black]{.3}
```

Remark: \tznodeframe works very similar to \tznode, but their ‘starred versions’ work differently. While \tznode* draws the perimeter of a node, \tznodeframe* fills a node with color.

```

% \tznodeframe*: opacity=.3 (by default)
\begin{tikzpicture}
\tzhelplines(4,3)
\tznodeframe(0,0)(A)
\tznodeframe(4,2)(B)[circle]
\tzline[blue,thick](A)(B)
\tznodeframe*[green,scale=1.5](2,1){Node frame}
[label=180:Left, pin=-45:pin]
\end{tikzpicture}

```

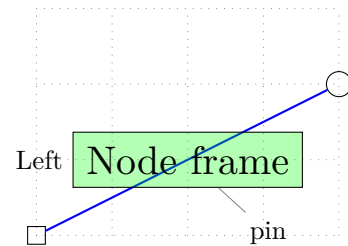

`\tznoderectangle` and `\tznodebox` are aliases of `\tznodeframe`. `\tznoderectangle*` and `\tznodebox*` are aliases of `\tznodeframe*`.

You can change the fill opacity of `\tznodeframe*` by specifying the last curly brace option `<fill opacity>`. You can also move the node by specifying the `<shift coord>` option immediately before the coordinate. (The *empty* shift option `<>` is *not allowed*.)

```

% \tznodeframe(*): opacity, shift
\begin{tikzpicture}
\tzhelplines[solid](4,3)
\tznodebox(0,0)
\tznoderectangle*(1,2)(A){A}{.1} % opacity
\tznodeframe[fill=yellow](2,2)(B){B}
\tznodeframe*[red](3,2)(C){Cat}
\tznodebox[fill=green]<-1,-2>(4,2)(D){Dog} % shift
\tzto[->,bend left=45](A.north)(C.90)
\tzto[->,bend right=45,dashed](B.-135)(D.west)
\end{tikzpicture}

```

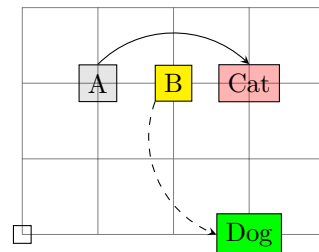

Remark: In addition to using the option `<fill opacity>`, you can use a macro to change the default value.

- The default fill opacity can be changed by the macro `\setztzfillopaicity`.
- The default fill color is `black!50`. You can use the macro `\setztzfillcolor` to change the default fill color.
- With `\tznodeframe`, you can change the color of the perimeter and text with the second bracket option `[<node opt>]`.

11.6 `\tznodecircle` and `\tznodecircle*`

`\tznodecircle` works just like `\tznodeframe` but with a circle node.

```

% syntax
\tznodecircle[<opt>]<shift coord>"<path name>"(<coord>)(<node name>)
{<text>}[<node opt>](<node size>)
% defaults
[draw,circle]<>"(<m>){}[text=black]
% defaults: if (<minimum size>) is give
[draw,circle,inner sep=0pt]<>"(<m>){}[text=black]()

```

`\tznodecircle*` works just like `\tznodeframe*` but with a circle node.

```

% syntax
\tznodecircle* [<opt>] <shift coord> "<path name>" (<coord>) (<node name>)
{<text>} [<node opt>] (<node size>) {<fill opacity>}
% defaults

```

```

*[circle,fill=black!50,fill opacity=.3,text opacity=1] <> ""
  (<m>){}[draw=black,text=black]{.3}
% defaults: if (<minimum size>) is given
*[circle,fill=black!50,fill opacity=.3,text opacity=1,inner sep=0pt] <> ""
  (<m>){}[draw=black,text=black](){.3}

```

```

% \tznodecircle
\begin{tikzpicture}
\tzhelplines(4,3)
\tznodecircle(0,0)(A)
\tznodecircle(4,2)(B)[circle]
\tzline[red,thick](A)(B)
\tznodecircle[blue,scale=1.5](2,1){Node frame}
  [label=180:Left, pin=-45:pin]
\end{tikzpicture}

```

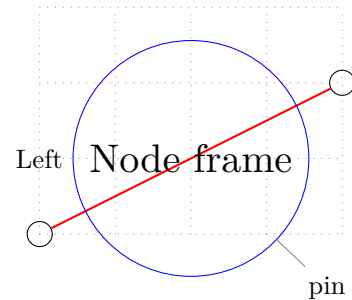

You can change the fill opacity of `\tznodecircle*` by specifying the last curly brace option `{<fill opacity>}` or using `\settzfillopacity`. You can also move the node by specifying the `<shift coor>` option immediately before the coordinate. The *empty* shift coordinate option `<>` is *not allowed*.

```

% opacity, shift
\begin{tikzpicture}
\tzhelplines[solid](4,3)
\tznodecircle(0,0)
\tznodecircle*(1,2)(A){A}{.1} % opacity
\tznodecircle[fill=yellow](2,2)(B){B}
\tznodecircle*[red](3,2)(C){Cat}
\tznodecircle[fill=green]<-1,-2>(4,2)(D){Dog} % shift
\tzto[->,bend left=45](A.north)(C.90)
\tzto[->,bend right=45,dashed](B.-135)(D.west)
\end{tikzpicture}

```

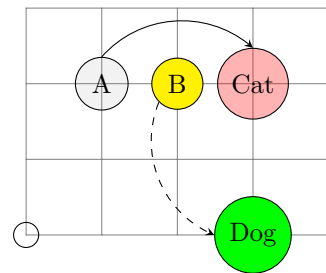

When the option `<minimum size>` is given, the TikZ option `inner sep=0pt` is added.

```

% \tznodecircle: (minimum size)
\begin{tikzpicture}
\tzhelplines(4,3)
\tznodecircle(2,1)(K1)(2cm)
\tznodecircle*[blue](1,1)(K2)(1cm)
\tznodecircle*[red](3,2)(K3)(10pt)
\end{tikzpicture}

```

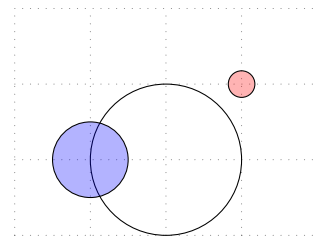

With the option `"<path name>"`, you can easily find intersection points on the circle.

```

% \tznodecircle*: "name path"
\begin{tikzpicture}
\tzhelplines(4,3)
\tznodecircle*[green]"AA"(2,1)(K)(2cm)
\tzline"BB"(0,3)(4,0)
\tzXpoint{AA}{BB}(X)
\tzdots*(X-1)(X-2);
\end{tikzpicture}

```

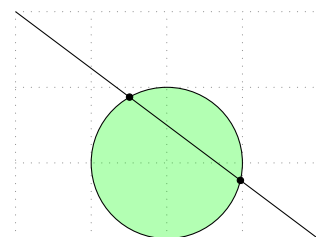

11.7 \tzcoortangenttocircle(*)

\tzcoortangenttocircle finds the *tangent coordinates* to a *node circle* from a point. This works together with \tznodecircle.

```
% syntax: minimum
\tzcoortangenttocircle(<node>(<point>(<coor name1>
% syntax: medium
\tzcoortangenttocircle(<node>(<point>(<coor name1>(<coor name2>)
% syntax: medium
\tzcoortangenttocircle[<dot opt>](<node>(<point>
      (<coor name1>){<text1>}[<node opt>]
      (<coor name2>){<text2>}[<node opt>]
% defaults
* [] (<m>(<m>(<m>){} [] () {} []
```

```
\tzcoortangenttocircle(A) (B) (X) % works like:
  \path (tangent cs:node=A,point={B},solution=1) coordinate (X) ;
  \path (tangent cs:node=A,point={B},solution=2) coordinate (X-2) ;
\tzcoortangenttocircle(A) (B) (X) (Y) % works like:
  \path (tangent cs:node=A,point={B},solution=1) coordinate (X) ;
  \path (tangent cs:node=A,point={B},solution=2) coordinate (Y) ;
```

When the solution 1 is named (X), you can use (X-1) instead, and the solution 2 is named (X-2) automatically. Even when the solution 1 is named (X) and the solution 2 is named (Y), you can still use (X-2) instead of (Y).

The starred version \tzcoortangenttocircle* prints dots (by \tzdot*) at the tangent coordinates. To change the dot size you can use the option tzdot or the macro \settzdotsize. (For more details, see Section 8.3.1 on page 46.)

```
% \tzcoortangenttocircle* with \tznodecircle
\begin{tikzpicture}
\tzhelplines(4,3)
\tznodecircle(1,1)(K)(2cm) %
\tzcoor*(4,3)(A){A}[O]
\tzcoortangenttocircle*(K)(A)(X) %
\tzline[red,tzextend={0pt}{1cm}](A)(X-1) % (X)=(X-1)
\tzline[blue,tzextend={0pt}{1cm}](A)(X-2)
\tznode(X-2){\texttt{X-2}}[br]
\end{tikzpicture}
```

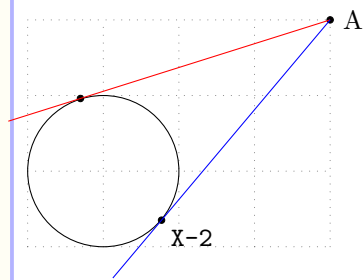

```
% \tzcoortangenttocircle
\begin{tikzpicture}
\tzhelplines(4,3)
\tznodecircle(1,1)(KK)(2cm)
\tzcoor*(4,3)(A){A}[O]
\tzcoortangenttocircle(KK)(A)(X){X}[90](Y){Y}[-45]
\tzline[red,tzextend={0pt}{1cm}](A)(X)
\tzline[blue,tzextend={0pt}{1cm}](A)(Y)
\tzpath*[red](A)(X)(KK.center);
\tzpath*[blue](A)(Y)(KK.center);
\tzrightanglemark(A)(X)(KK.center)
\tzrightanglemark(A)(Y)(KK.center)
\end{tikzpicture}
```

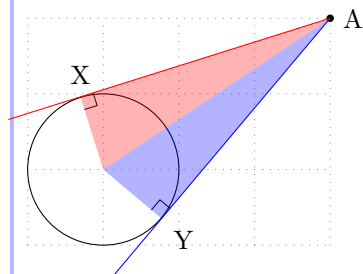

11.8 \tznodeellipse and \tznodeellipse*

\tznodeellipse works just like \tznodeframe but with an ellipse node.

```
% syntax:
\tznodeellipse[<opt>]<shift coord><coord>(<node name>){<text>}[<node opt>]
% defaults
[ellipse]<>(<m>){}[text=black]
```

The starred version \tznodeellipse* works just like \tznodeframe* but with an ellipse node.

```
% syntax:
\tznodeellipse*[<opt>]<shift coord>
                (<coord>)(<node name>){<text>}[<node opt>]{<fill opacity>}
% defaults
*[ellipse,fill=black!50,fill opacity=.3,text opacity=1] <>
(<m>){}[draw=black,text=black]{.3}
```

```
% \tznodeellipse
\begin{tikzpicture}
\tzhelplines(4,3)
\tznodeellipse(0,3)
\tznodeellipse(0,0)(A)
\tznodeellipse(4,2)(B)[circle]
\tzline[blue,thick](A)(B)
\tznodeellipse[scale=1.5](2,1){Node frame}
                [label=180:Left, pin=-45:pin]
\end{tikzpicture}
```

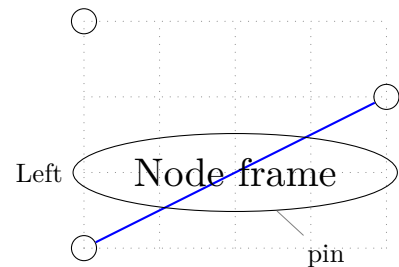

\tznodeoval and \tznodeoval* are aliases of \tznodeellipse and \tznodeellipse*, respectively.

You can change the fill opacity of \tznodeellipse* by specifying the last curly brace option {<fill opacity>}. You can also move the node by specifying the <shift coord> option immediately before the coordinate. The *empty* shift option <> is *not allowed*.

```
% opacity, shift
\begin{tikzpicture}
\tzhelplines[solid](4,3)
\tznodeellipse(0,0)
\tznodeoval*(1,2)(A){A}{.1} % opacity
\tznodeoval[fill=yellow](2,2)(B){B}
\tznodeellipse*[red](3,2)(C){Cat}
\tznodeellipse[fill=green]<-1,-2>(4,2)(D){Dog} % shift
\tzto[->,bend left=45](A.north)(C.90)
\tzto[->,bend right=45,dashed](B.-135)(D.west)
\end{tikzpicture}
```

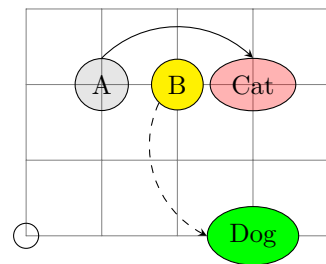

12 Lines

12.1 \tzline: Connecting two points

\tzline connects two points with a straight line.

```

% syntax: minimum
\tzline(<coor1>)(<coor2>)
% syntax: medium
\tzline[<opt>](<coor1>){<text1>}[<node opt1>]
      (<coor2>){<text2>}[<node opt2>]
% syntax: full
\tzline[<opt>]<shift coor>"<path name>"
      (<coor1>){<text1>}[<node opt1>]
      (<coor2>){<text2>}[<node opt2>]<code.append>
% defaults
[]<>"(<m>){}[above](<m>){}[]<>

```

```

\tzline(0,1)(2,1) % works like:
\draw (0,1) -- (2,1);

```

12.1.1 Line styles

You can use the first optional argument [`<opt>`] to control the line styles.

```

\tzline[blue](0,1)(2,1) % works like:
\draw [blue] (0,1) -- (2,1);

```

```

% \tzline
\begin{tikzpicture}
\tzhelplines(4,3)
\tzline[blue,->](0,0)(3,3)
\tzline[<->](0,2)(3,0)
\tzline[dashed](1,2)(4,0)
\tzdots*(1,2)(4,0);
\end{tikzpicture}

```

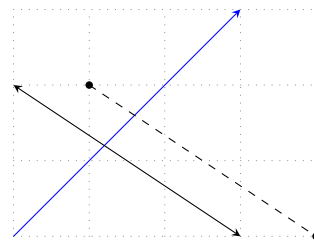

12.1.2 Adding text

You can add text by specifying the optional arguments {<text>} and [<node opt>].

Text next to the line With the options {<text1>}[<node opt1>] *in-between* two coordinates, you can add text next to the line, with the option [above,midway] by default.

```

\tzline[blue](0,1){my line}[sloped](2,1) % works like:
\draw [blue] (0,1) -- node [above,sloped] {my line} (2,1) ;

```

```

% \tzline: text next to line
\begin{tikzpicture}
\tzhelplines(4,3)
\tzline(0,0){Above}(4,0) % default [above]
\tzline[blue](0,1){Near end}[b,near end](4,1) % below
\tzline[->](0,2){Sloped}[sloped](3,3) % default [above]
\end{tikzpicture}

```

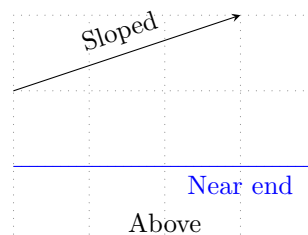

You can use the *abbreviations* (or aliases) of TikZ basic placement options such as `a` for above, `bl` for below left, and so on. (For more details, see page 2.)

Text at or around the last coordinate You can also add text at (by default) or around the second coordinate by specifying `{<text2>}` and `[<node opt2>]` immediately *after* the second coordinate.

```
\tzline[blue](0,1)(2,1){my line}[r]    % works like:
\draw [blue] (0,1) -- (2,1) node [right] {my line};
```

```
% \tzline
\begin{tikzpicture}
\tzhelplines(4,3)
\tzline[blue,->](0,0)(3,3){\textbf{line A}}[r]
\tzline[<->](0,2)(3,0){line B}[red,draw=blue,b=1mm]
\tzline[dashed](1,2){dashed}[sloped](4,0){line C}[ar]
\tzdots*(1,2)(4,0);
\end{tikzpicture}
```

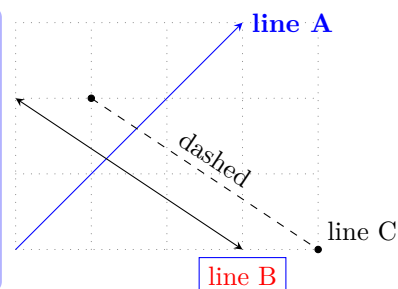

12.1.3 Moving lines: shift

You can move the line generated by `\tzline` by specifying the option `<shift coor>` before the first coordinate (to be precise, immediately before the option "`<path name>`", which is put immediately before the first coordinate, if it exists). The empty shift `<>` is not allowed.

```
% \tzline: shift
\begin{tikzpicture}
\tzhelplines(4,3)
\tzline[blue,->](0,0)(3,3){A}[r]
\tzline[blue] <1,0>(0,0)(3,3){A}[r]
\tzline[dashed](1,2)(4,0){C}[r]
\tzline[dashed]<-.5,-.5>(1,2)(4,0){C}[r]
\tzdots*(1,2)(4,0);
\end{tikzpicture}
```

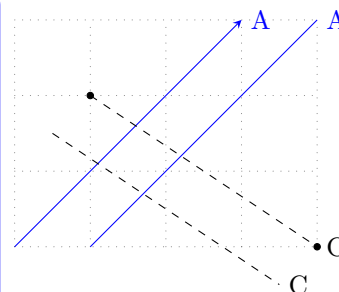

12.1.4 Extending paths

You can extend the path of `\tzline` from the last coordinate, by writing TikZ code in the last optional argument `<code.append>`.

```
% \tzline: shift
\begin{tikzpicture}
\tzhelplines(4,3)
\tzline[blue,->](0,0)(3,3)<arc(0:-60:1cm)>
\tzline[dashed,->](1,2)(4,0)
<to[bend left] ++(-4,1) node [a] {ends here!}>
\end{tikzpicture}
```

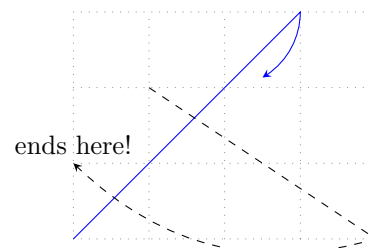

You can also use `\tzlineAtBegin` and `\tzlineAtEnd` to extend a path of `\tzline` at the beginning and at end, respectively. Specifying `<code.append>` extends the path after `\tzlineAtEnd`.

```

% \tzline: shift
\begin{tikzpicture}
\tzhelplines(4,3)
\tzline[blue,->](0,0)(3,3)<arc(0:-60:1cm)>
\tzlineAtBegin{(2,3) -|}
\tzlineAtEnd{ arc (-90:90:.5) node [a] {here?} }
\tzline[dashed,->](1,2)(4,0)
  < to[bend left] ++(-4,1) node [a] {ends here!} >
\end{tikzpicture}

```

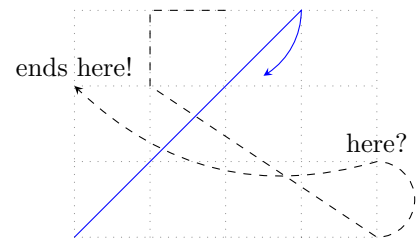

12.1.5 Naming paths: Intersection points

When you specify the option "<path name>" immediately before the first coordinate, it works like [name path=<path name>] in the option list of [<opt>]. You can use this name of path to find intersection points.

```

% \tzline+: name path
\begin{tikzpicture}
\tzhelplines(4,3)
\tzline[blue,->] "dem" (0,0)(3,3){demand}[r]
\tzline[dashed,->]"supp"(1,2)(4,0){supply}[ar]
% intersection point
\tzXpoint*{dem}{supp}
\end{tikzpicture}

```

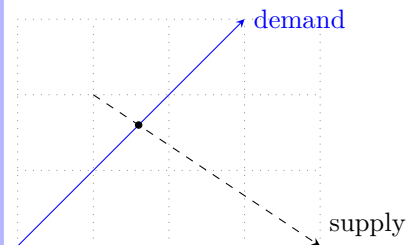

12.2 \tzline+: Relative coordinates

The *plus version* \tzline+ takes the second coordinate (<coor2>) relative (with ++) to the first coordinate (<coor1>).

Everything else is the same as in \tzline.

```

% syntax: full
\tzline+ [<opt>] <shift coor> "<path name>"
  (<coor1>){<text1>}[<node opt1>]
  (<coor2>){<text2>}[<node opt2>]<code.append>
% defaults
+[] <>" (<m>){}[above] (<m>){} [] <>

```

```

\tzline+(0,1)(2,1) % works like:
\draw (0,1) -- ++ (2,1);

```

```

\tzline+[dashed]"AA"(0,1){A}[red](2,1){B}[right,blue] % works like:
\draw [dashed,name path=AA]
  (0,1) -- node [red] {A} ++ (2,1) node [right,blue] {B};

```



```

% \tzline+
\begin{tikzpicture}
\tzhelplines(4,3)
\tzline+[blue,->](0,1)(3,2){A}[r]
\tzline+[<->](0,2){b}(3,-2){B}[r]
\tzline+[dashed]<1,0>(0,2){b}(3,-2){B}[r]
\end{tikzpicture}

```

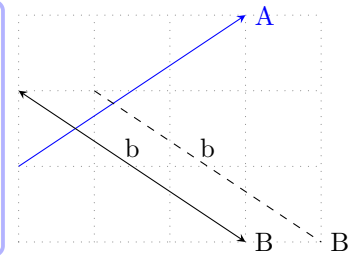

```

% \tzline+: name path
\begin{tikzpicture}
\tzhelplines(4,3)
\tzline+[blue,->] "dem" (0,0)(3,3){demand}[r]
\tzlineAtBegin{(0,1) to [bend left] }
\tzline+[dashed,->]"supp"(1,2)(3,-2){supply}[ar]
% intersection point
\tzXpoint*{dem}{supp}
\end{tikzpicture}

```

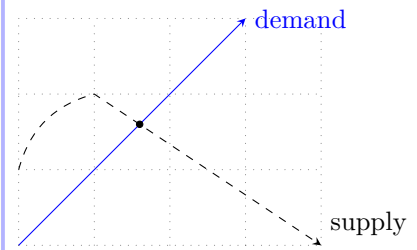

12.3 Styles: tzshorten and tzextend

The styles `tzshorten` and `tzextend` are defined as follows:

```

% tzshorten
\tikzset{%
  tzshorten/.style 2 args ={shorten <=#1, shorten >=#2},
  tzshorten/.default={2pt}{2pt}
}

% tzextend (negative tzshorten)
\tikzset{%
  tzextend/.style 2 args ={shorten <=-#1, shorten >=-#2},
  tzextend/.default={2pt}{2pt}
}

```

For example, `[tzshorten={2mm}{1mm}]` is equivalent to `[shorten <=2mm,shorten >=1mm]` in TikZ. Simple `[tzshorten]` means `[tzshorten={2pt}{2pt}]` by default.

The style `tzextend` is a negative `tzshorten`. For example, `tzextend{2mm}{1mm}` is equivalent to `tzshorten{-2mm}{-1mm}`.

```

% tzshorten, tzextend
\begin{tikzpicture}
\tzhelplines(4,3)
\tzdots(0,0)(3,0); \tzline(0,0)(3,0)
\tzdots(0,1)(3,1);
\tzline[->,thick,blue,tzshorten={2mm}{1mm}](0,1)(3,1)
\tzdots(1,2)(3,2);
\tzline[<->,thick,red,tzextend={1cm}{1cm}](1,2)(3,2)
\end{tikzpicture}

```

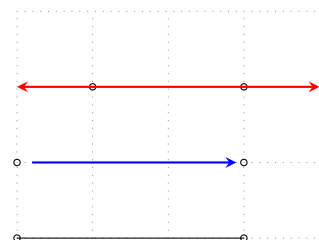

12.4 \tzlines: Connecting multiple points: Semicolon version

`\tzlines` connects two or more points with connected line segments. Since `\tzlines` takes an arbitrary number of coordinates as arguments, it is a *semicolon version*. So, you need to enter a

semicolon ‘;’ to indicate when the coordinate iteration ends.

```
% syntax: minimum
\tzlines(<coord>(<coord>)..repeated..(<coord>) ;
% syntax: medium
\tzlines(<coord>{<text>}[<node opt>]..repeatd..(<coord>){<text>}[<node opt>] ;
% syntax: full
\tzlines[<opt>]<shift coord>"<path name>"
    (<coord>){<text>}[<node opt>]
    ..repeated.. (){}[] ; <code.append>
% defaults
[]<>" (<m>){}[] ..repeated.. (){}[] ; <>
```

```
\tzlines(1,1)(2,2)(3,1)(4,3); % works like:
\draw (1,1) -- (2,2) -- (3,1) -- (4,3);
```

The whole repeating pattern in `\tzlines` is the triple `(<coord>){<text>}[<node opt>]`.

```
\tzlines(1,1)(2,2)(3,1){C}(4,3){D}[r]; % works like:
\draw (1,1) -- (2,2) -- (3,1) -- node {C} (4,3) node [right] {D};
```

Line styles Use the first optional argument [`<opt>`] to control the style of the connected line drawn by `\tzlines`.

```
% \tzlines: line style
\begin{tikzpicture}
\tzhelplines(4,3)
\tzlines[blue,<->](0,1)(1,2)(3,1)(4,3); % semicolon
\tzlines[dashed](0,0)(1,1)(2,1)(3,0);
\end{tikzpicture}
```

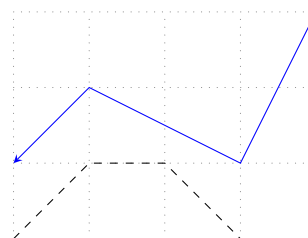

Adding text You can add text in the midway, by default, of each line segment by specifying the options `{<text>}` and `[<node opt>]` immediately after each coordinate (except the last one). The options `{<text>}` and `[<node opt>]` after the last coordinate put `<text>` at or around the last coordinate.

```
% \tzlines: adding text
\begin{tikzpicture}
\tzhelplines(4,3)
\tzlines[red,thick,<->,text=blue]
    (0,1){Up}
    (1,2){Down}[a,sloped]
    (3,1){Up}
    (4,3){line A} ;
\tzlines[dashed](0,0)(1,1)(2,1)(3,0){line B}[r];
\end{tikzpicture}
```

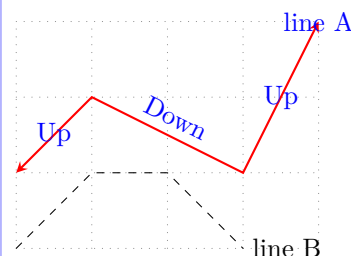

Shift You can move the connected line by specifying `<shift coord>` before the first coordinate or immediately before the option `"<path name>"` if it exists. (The empty shift option `<>` is not allowed.)

```

% \tzlines: shift
\begin{tikzpicture}
\tzhelplines(4,3)
\tzlines[red,thick,<->,text=blue]
  <0,-1>(0,1)
  (1,2)
  (3,1)
  (4,3){shifted\\line A}[align=left,ar] ;
\tzlines[dashed]<1,0>(0,0)(1,1)(2,1)(3,0){line B}[r] ;
\end{tikzpicture}

```

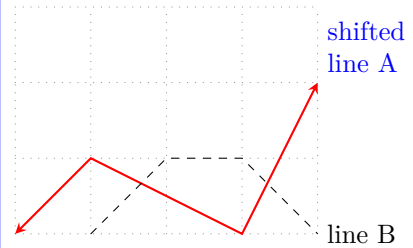

Naming paths You can name the path of `\tzlines` by specifying the option "`<path name>`" immediately before the first coordinate.

```

% \tzlines: shift, intersection
\begin{tikzpicture}
\tzhelplines(4,3)
\tzlines[red,thick,<->,text=blue]
  <0,-1>"AA"(0,1)
  (1,2)(3,1)(4,3){shifted\\line A}[align=left,ar] ;
\tzlines[dashed]
  <1,0>"BB"(0,0)(1,1)(2,1)(3,0){line B}[r] ;
% intersection points
\tzXpoint*{AA}{BB}(X){X1}[-90] % [<angle>] for point
\tzdot(X-2){X2}[0] % [<angle>] for dot
\end{tikzpicture}

```

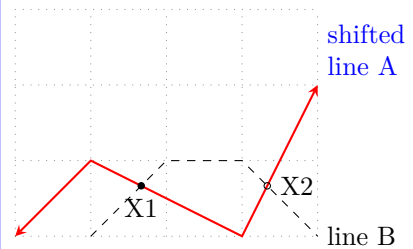

Extending paths You can extend the path of `\tzlines` by writing TikZ code in the *last* (even after the semicolon) optional argument `<code.append>`.

```

% \tzlines: <code.append>
\begin{tikzpicture}
\tzhelplines(4,3)
\tzlines[red,thick,<->,text=blue]
  (0,1){Up}
  (1,2){Down}[a,sloped]
  (3,1){Up}
  (4,3) ;
  <arc(0:90:1cm)>
\tzlines[dashed]
  (0,0)(1,1)(2,1)(3,0) ;
  <to[bend right] ++(2,2) node{Here!}>
\end{tikzpicture}

```

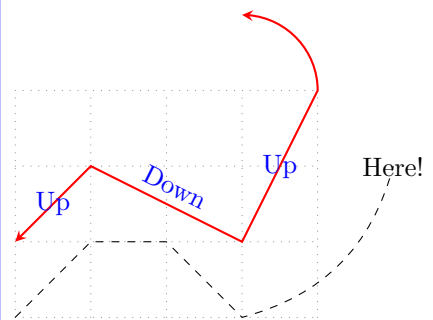

You can close the path with a straight line by `<--cycle>`.

```

% \tzlines: closed path
\begin{tikzpicture}
\tzhelplines(4,3)
\tzlines[red,thick,<->,text=blue]
  (0,1){Up}
  (1,2){Down}[a,sloped]
  (3,1){Up}
  (4,3){line A} ; <--cycle>
\tzlines[dashed]
  (0,0)(1,1)(2,1)(3,0){line B}[r] ; <--cycle>
\end{tikzpicture}

```

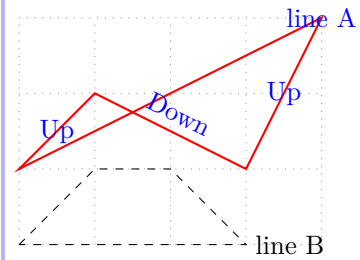

You can also use `\tzlinesAtBegin` and `\tzlinesAtEnd` to extend a path of `\tzlines` at the beginning and at the end, respectively. Specifying `<code.append>` extends the path after `\tzlinesAtEnd`, if it exists.

```

% \tzlines: extending paths
\begin{tikzpicture}
\tzhelplines(4,3)
\tzlinesAtBegin{(1,3) to [bend right]}
\tzlinesAtEnd{arc(0:90:1cm)}
\tzlines[red,thick,<->,text=blue]
  (0,1){Up}
  (1,2){Down}[a,sloped]
  (3,1){Up}
  (4,3) ;
\tzlinesAtEnd{to[bend right] ++(2,2) node{Here!}}
\tzlines[dashed]
  (0,0)(1,1)(2,1)(3,0){not here}[b];
  <-| ++(-1,-1) node [draw,b] {Ends here!!} >
\end{tikzpicture}

```

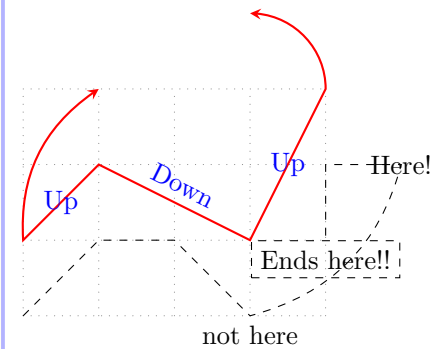

12.5 \tzlines+: Relative coordinates: Semicolon version

The *plus version* `\tzlines+` connects two or more points with connected line segments, but each coordinate (except the first one) is *relative* to the previous coordinate.

Everything else is the same as in \tzlines. It is also required to enter a *semicolon* to indicate when the coordinate iteration ends.

```

% syntax: minimum
\tzlines+ (<coor>)(<coor> ..repeat.. (<coor>) ;
% syntax: full
\tzlines+ [<opt>] <shift coor> "<path name>"
  (<coor>){<text>}[<node opt>]
  ..repeated.. (){}[] ; <code.append>
% defaults
[] <>" (<m>){}[] ..repeated.. (){}[] ; <>

```

```

\tzlines+(0,1)(1,1)(2,-1)(1,2); % works like:
\draw (0,1) -- ++(1,1) -- ++(2,-1) -- ++(1,2);

```

```

\tzlines+[dashed]"AA"(0,1){A}(1,1){B}(2,-1){C}(1,2){D}[right]; % works like:
\draw [dashed,name path=AA]
(0,1) -- node {A} ++(1,1)
      -- node {B} ++(2,-1)
      -- node {C} ++(1,2) node [right] {D} ;

```

```

% \tzlines+
\begin{tikzpicture}
\tzhelplines(4,3)
\tzlines+[red,thick,<->,text=blue]
(0,1){Up}
(1,1){Down}[a,sloped]
(2,-1){Up}
(1,2){line A} ;
\tzlines+[dashed,auto,text=red]
(0,0){A}
(1,1){B}
(1,0){C}
(1,-1){line B}[blue,draw,r] ;
\end{tikzpicture}

```

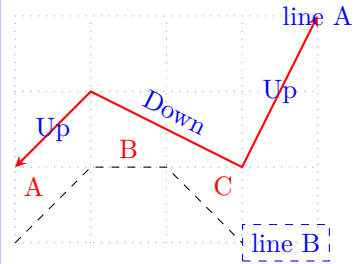

```

% \tzlines+: shift
\begin{tikzpicture}
\tzhelplines*(4,3)
\tzlines+[red,thick,<->,text=blue]
<1,1> (0,1){Up}
(1,1){Down}[a,sloped]
(2,-1){Up}
(1,2){line A} ;
\tzcoors(0,0)(A)(1,1)(B)(1,0)(C)(1,-1)(D);
\tzlines+[dashed,auto,text=red]
<-1,.5> (A){A}
(B){B}
(C){C}
(D){line B}[blue,draw,r] ;
\end{tikzpicture}

```

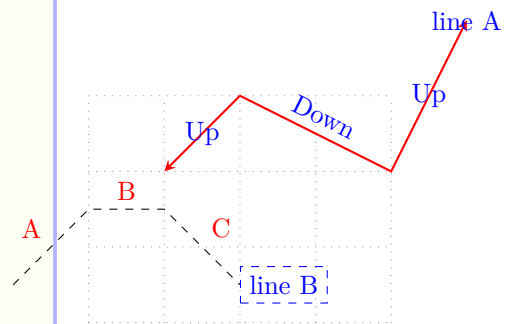

13 Connecting Points

13.1 \tzto: Two points

\tzto connects two points with a straight or curved line, using TikZ's to operation. So \tzto is more general than \tzline, which only connects points only with a straight line.

```
% syntax: minimum
\tzto(<coord>)(<coord>)
% syntax: medium
\tzto[<opt>](<coord>){<text>}[<node opt>](<coord>){<text>}[<node opt>]
% syntax: full
\tzto[<opt>]<shift coord>"<path name>"
    (<coord>){<text>}[<node opt>]
    (<coord>){<text>}[<node opt>]<code.append>
% defaults
[]<>"(<m>){}[above](<m>){}[]<>
```

```
\tzto[dashed](1,1)(3,2) % works like:
\draw [dashed] (1,1) to (3,2);
```

Line styles You can control line styles with the first optional argument [opt].

```
% \tzto
\begin{tikzpicture}
\tzhelplines(4,3)
\tzto[blue,thick](0,1)(3,3)
\tzto[out=0](0,0)(4,2)
\tzto[bend right,dashed](2,0)(4,1)
\settzmidarrow{o}[very thick,red]
\tzarc(2,2)(180:45:1cm)
\end{tikzpicture}
```

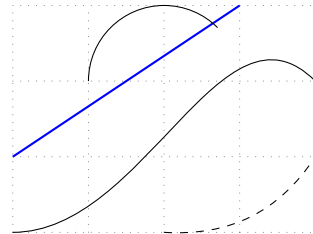

Adding text You can add text *next to the line* ([midway,above], by default) by specifying the options {<text>} and [node opt] *in-between* the two coordinates.

```
\tzto[->,bend right](1,1){A}[near start](3,2) % works like:
\draw [->,bend right] (1,1) to node [near start] {A} (3,2);

\tzto[->,bend right](1,1){A}[near start](3,2){B}[right] % works like:
\draw [->,bend right] (1,1) to node [near start] {A}
    (3,2) node [right] {B};
```

You can also add text *at or around* the last coordinate by the options {<text>} and [node opt] *immediately after* the last coordinate.

```

% \tzto: adding text
\begin{tikzpicture}
\tzhelplines(4,3)
\tzto[blue,thick,->](0,1){line}[sloped](3,3)
\tzto[out=0](0,0){curve}[pos=.8](4,2){line B}[r]
\tzto[bend right,dashed](2,0)(4,1){line C}[red,r]
\end{tikzpicture}

```

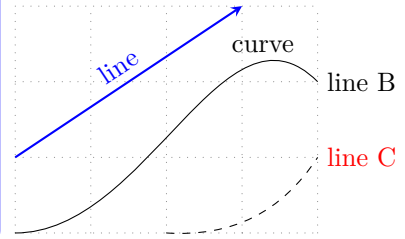

Shift You can move the line by specifying the option `<shift coor>` before the first coordinate or immediately before the option `"<path name>"` if it exists. (The *empty* shift option `<>` is *not* allowed.)

```

% \tzto: shift
\begin{tikzpicture}
\tzhelplines(4,3)
\tzto[blue,thick,->]<0,1>(0,1){line}[sloped](3,3)
\tzto[out=0]<1,1>(0,0){curve}[pos=.8](4,2){line B}[r]
\tzto[bend right,dashed]<-1,0>(2,0)(4,1){line C}[red,r]
\end{tikzpicture}

```

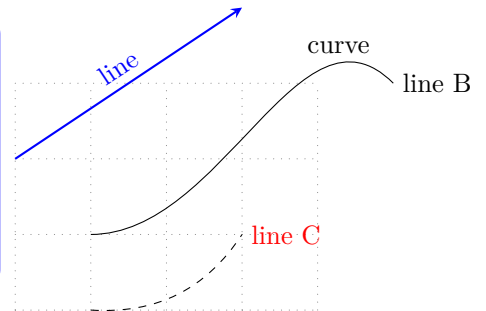

Naming paths: Intersections You can name the path of `\tzto` by specifying the option `"<path name>"` immediately before the first coordinate.

```

% \tzto: name path
\begin{tikzpicture}
\tzhelplines(4,3)
\tzto[bend right=45,blue,thick,->]"curveA"(1,3)(4,0)
\tzto[out=0]"curveB"(0,0)(4,2){line B}[r]
% intersection point
\tzXpoint*{curveA}{curveB}
\end{tikzpicture}

```

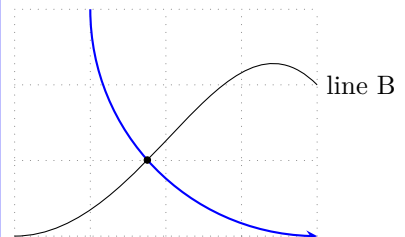

Extending the path You can extend the path of `\tzto` by writing TikZ code in the last optional argument `<code.append>`.

```

% \tzto: extending path
\begin{tikzpicture}
\tzhelplines(4,3)
\tzto[bend right=45,blue,thick,->](1,3)(4,0)
<--([turn]0:1cm) node [b] {extended}>
\tzto[out=0](0,0)(4,2)
<--([turn]0:1cm) node [r] {extended}>
\end{tikzpicture}

```

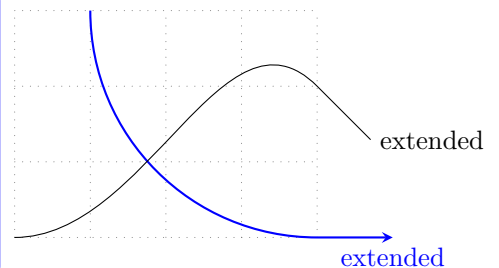

You can also use `\tztoAtBegin` and `\tztoAtEnd` to extend a path of `\tzto` at the beginning and at the end, respectively. Specifying `<code.append>` extends the path after `\tztoAtEnd`.

```

% \tzto: extending path
\begin{tikzpicture}
\tzhelplines(4,3)
\tztoAtBegin{(0,2) to [bend left]}
\tztoAtEnd{--[turn]0:1cm) node [b] {extended}}
\tzto[bend right=45,blue,thick,->](1,3)(4,0)
\tztoAtEnd{--[turn]0:1cm) node [r] {extended}}
\tzto[out=0](0,0)(4,2)
\end{tikzpicture}

```

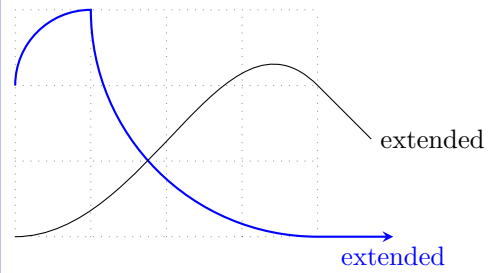

13.2 \tzto+: Relative coordinates

The *plus version* \tzto+ uses the second coordinate relative to the first coordinate.

Everything else is the same as in \tzto.

```

\tzto+(1,1)(3,2) % works like:
\draw (1,1) to ++(3,2);

```

```

% \tzto+
\begin{tikzpicture}
\tzhelplines(4,3)
\tzto+[blue,thick,->](0,1){line}[sloped](3,2)
\tzto+[out=0](0,0){curve}[pos=.8](4,2){line B}[r]
\tzto+[bend right,dashed](2,0)(2,1){line C}[red,r]
\end{tikzpicture}

```

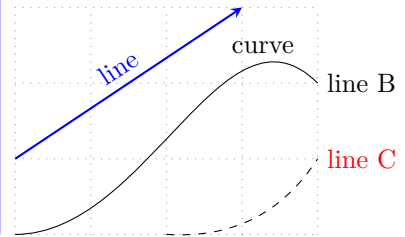

```

% \tzto+
\begin{tikzpicture}
\tzhelplines(4,3)
\tzto+[bend right=45,blue,thick,->](1,3)(3,-3)
<--[turn]0:1cm) node [b] {extended}>
\tzto+[out=0](0,0)(4,2)
<--[turn]0:1cm) node [r] {extended}>
\end{tikzpicture}

```

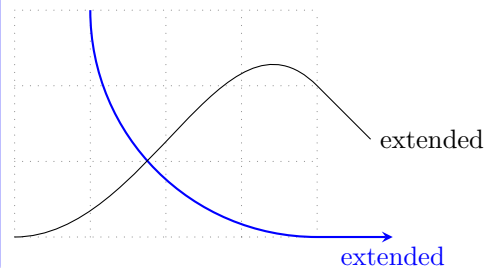

```

% \tzto: extending path
\begin{tikzpicture}
\tzhelplines(4,3)
\tztoAtBegin{(0,2) to [bend left]}
\tztoAtEnd{--[turn]0:1cm) node [b] {extended}}
\tzto+[bend right=45,blue,thick,->](1,3)(3,-3)
\tztoAtEnd{--[turn]0:1cm) node [r] {extended}}
\tzto+[out=0](0,0)(4,2)
\end{tikzpicture}

```

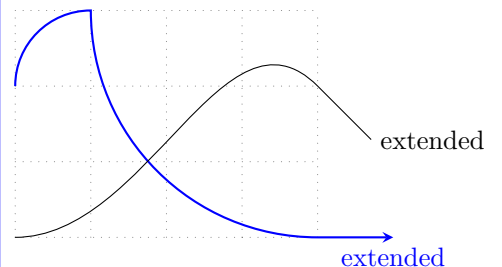

13.3 \tztoS: Multiple points: Semicolon version

\tztoS takes an arbitrary number of coordinates as arguments to connect them by the TikZ's to operation. \tztoS is much more flexible than \tzlines. Since this is a *semicolon version*, you need to enter a *semicolon* to indicate when the coordinate iteration ends.

```

% syntax
\tztos[<opt>]<shift coor>"<path name>"
    (<coor1>)[<to opt>]{<text>}[<node opt>]..repeated..() []{}[] ; <code.append>
% defaults
[]<>"(<m>) []{}[]..repeated..() []{}[];<

```

The quadruple (<coor>)[<to opt>]{<text>}[<node opt>] is the whole repeating pattern. Here, [<to opt>] is for the options of TikZ's to operation such as [bend right], [bend left], [bend left=<angle>], [out=<angle>,in=<angle>] and so on.

```

\tztos(0,0)(1,2)(3,1); % works like:
\draw (0,0) to (1,2) to (3,1);

```

```

\tztos[blue] (0,0) [bend right] (1,2) [out=-60,in=45] (3,1); % works like:
\draw[blue] (0,0) to [bend right] (1,2) to [out=-60,in=45] (3,1);

```

How to connect coordinates You can use the options of TikZ's to operation to connect the coordinates with different types of curves.

```

% \tztos
\begin{tikzpicture}
\tzhelplines(4,3)
\tztos[blue,<->](0,1)(1,2)(3,1)(4,3);
\tztos[red,thick]
(0,0)[bend right]
(1,1)
(2,1)[out=-135,in=45]
(3,0);
\end{tikzpicture}

```

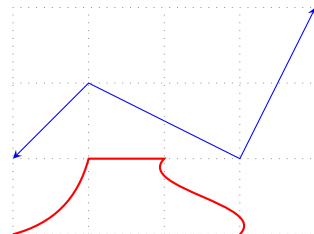

```

% \tztos
\begin{tikzpicture}
\tzhelplines(4,3)
\tzcoors*(0,0)(A)(1,2)(B){B}[b](3,3)(C)(4,2)(D);
\tztos(A)[out=80,in=180]
(B)[out=0,in=180]
(C)[out=0,in=180]
(D){End!}[r];
\end{tikzpicture}

```

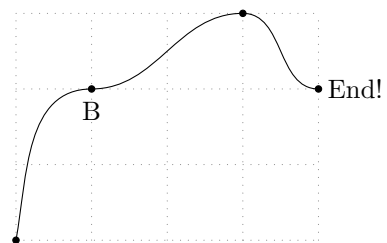

Adding text You can add text next to lines or curves by specifying the options {<text>} and [<node opt>] *in-between* coordinates or *after* the option [<to opt>], if it exists. You can also add text at or around the last coordinate by the last options {<text>} and [<node opt>].

```

% \tztos: adding text
\begin{tikzpicture}
\tzhelplines(4,3)
\tztos(0,1)[bend right]{A}
    (1,2)      {Ben}[red,sloped,a]
    (3,1)[bend right]{Cate}[sloped,near end]
    (4,3)      {Name}[draw,blue,a] ;
\end{tikzpicture}

```

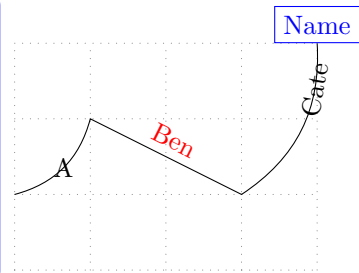

Shift You can move the line or curve of `\tztos` using the option `<shift coor>` before the first coordinate or immediately before the option "`<path name>`", if any. (The empty shift option `<>` is not allowed.)

```

% \tztos: shift
\begin{tikzpicture}
\tzhelplines(4,3)
\tzdot(0,0)
\tztos[blue,<->](0,1)(1,2)(3,1)(4,3);
\tztos[red,thick]
  <1,1>(0,0)[bend right]
    (1,1)
    (2,1)[out=-135,in=45]
    (3,0);
\end{tikzpicture}

```

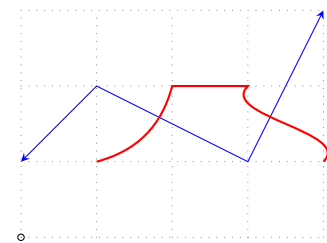

Naming paths: intersections You can name the path of `\tztos` by specifying "`<path name>`" immediately before the first mandatory coordinate.

```

% \tztos: name path, intersection points
\begin{tikzpicture}
\tzhelplines(4,3)
\tzdot(0,0)
\tztos[blue,<->]"AA"(0,1)(1,2)(3,1)(4,3);
\tztos[red,thick]
  <1,1>"BB"(0,0)[bend right]
    (1,1)
    (2,1)[out=-135,in=45]
    (3,0);

% intersection points
\tzXpoint*{AA}{BB}(X)
\tzdot(X-2)(4pt)
\end{tikzpicture}

```

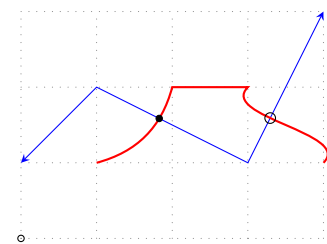

Extending paths You can extend the path of `\tztos` from the last coordinate, by writing TikZ code in the last (after the semicolon) optional argument `<code.append>`.

```

% \tztos
\begin{tikzpicture}
\tzhelpplines(4,3)
\tztos[blue](0,1)(1,2)(3,1)(4,3);<--cycle>
\tztos[red,thick]
(0,0)[bend right]
(1,1)
(2,1)[out=-135,in=45]
(3,0); < to ([turn]0:1.5cm) >
\end{tikzpicture}

```

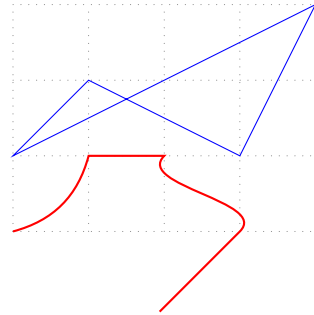

You can also use `\tztosAtBegin` and `\tztosAtEnd` to extend a path of `\tztos` at the beginning and at the end, respectively. Specifying the option `<code.append>` extends the path after `\tztosAtEnd`.

```

% \tztos
\begin{tikzpicture}
\tzhelpplines(4,3)
\tztos[blue](0,1)(1,2)(3,1)(4,3);<--cycle>
\tztosAtBegin{ (1,3) -| }
\tztosAtEnd{ to ([turn]0:1.5cm) }
\tztos[red,thick]
(0,0)[bend right]
(1,1)
(2,1)[out=-135,in=45]
(3,0);
\end{tikzpicture}

```

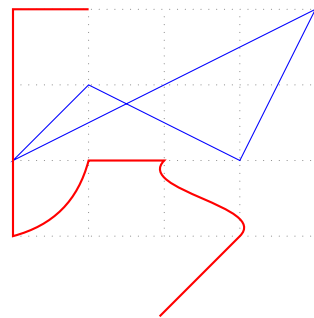

13.4 `\tztos+`: Relative coordinates: Semicolon version

The *plus version* `\tztos+` takes each coordinate (except the first coordinate) relative (with `++`) to the previous coordinate.

Everything else is the same as in `\tztos`.

```

% \tztos+
\begin{tikzpicture}
\tzhelpplines(4,3)
\tztos+[blue](0,1)(1,1)(2,-1)(1,2);<--cycle>
\tztos+[red,thick]
(0,0)[bend right]
(1,1)
(1,0)[out=-135,in=45]
(1,-1); < to ([turn]0:1.5cm) >
\end{tikzpicture}

```

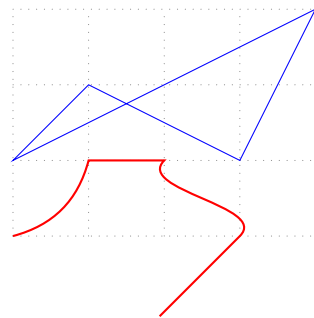

13.5 `\tzlink`: Two points

`\tzlink` is a *generalized version* of `\tzline`. You can decide the style that links two coordinates.

The default link style is `to`, which can be changed with the *second* optional argument [`<code1>`] *between two coordinates* like, for example, (`<coord1>`) [`-|`] (`<coord2>`). Another way is to use the *first* curly brace option `{<link style>}`. You can also change it by `\setztzlinkstyle` like, for example, `\setztzlinkstyle{-|}`, which is effective until the end of the `tikzpicture` environment.

```

% syntax: minimum
\tzlink(<coor1>)(<coor2>) % default: to
% syntax: medium
\tzlink[<opt>](<coor1>)[<code1>](coor2) % change link style by [<code1>]
% syntax: full
\tzlink{<link style>}[<opt>]<shift coor>"path name"
    (<coor1>)[<code1>]{<text1>}[<node opt1>]<code2>
    (<coor2>){<text2>}[<node opt2>]<code.append>
% remark:
- {<link style>}: % default: to
- [<code1>]: --, -, |, to, edge, etc. (optionally more appropriate tikz code)
- [<code2>]: + or ++ (possibly with other tikz code)
- {<text1>}: node text next to line
- {<text2>}: node text at the last coordinate
% defaults
{to}[]<>""(<m>)[]{}[above]<>(<m>){}[]<>

```

```

\tzlink(1,0)(3,1) % works like:
\draw (1,0) to (3,1);

```

```

\tzlink(1,0)[-|<+>](3,1) % works like:
\draw (1,0) -| ++ (3,1);

```

Link styles You can change the link style (to by default) using the optional argument [<code1>] immediately after the first coordinate.

```

% \tzlink: to (default link style)
\begin{tikzpicture}
\tzhelplines(4,3)
\tzlink[->](0,0)(1,0)
\tzlink[->,bend right](0,2)(3,0)
\tzlink[->](1,2)[-|](4,1)
\end{tikzpicture}

```

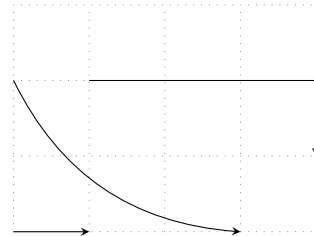

You can also use `\settzlinkstyle` to change the link style. Its effect is valid until the end of the `tikzpicture` environment, unless changed again.

```

% \settzlinkstyle
\begin{tikzpicture}
\tzhelplines(4,3)
\settzlinkstyle{to[bend left]} %%
\tzlink[->](0,0)(1,0)
\tzlink[->](0,2)[->](3,0) % local change
\tzlink[->](1,2)(4,1)
\end{tikzpicture}

```

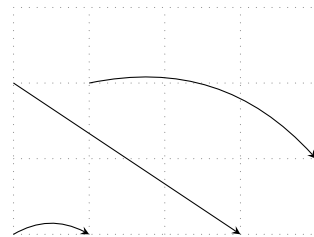

The *plus version* `\tzlink+` uses the second coordinate relative (with `++`, by default) to the first one. Everything else is the same as in `\tzlink`.

```

\tzlink (1,0)[to[bend right]]{A}[a<+>>(3,1) % or
\tzlink+(1,0)[to[bend right]]{A}[a (3,1) % works like:
\draw (1,0) to[bend right] node [above] {A} ++ (3,1);

```

```

% \tzlink(+): various link styles
\begin{tikzpicture}
\tzhelplines(4,3)
\tzlink[->,blue,out=90,in=180](0,2)(3,0)
\tzlink+[->,dashed,blue](1,2)[to[bend left]](3,-1)
\tzlink[->](0,0)[..controls (1,1) and (3,0)..](4,2)
\tzlink+[red,thick](1,0)[edge[bend left]](2,3)
\end{tikzpicture}

```

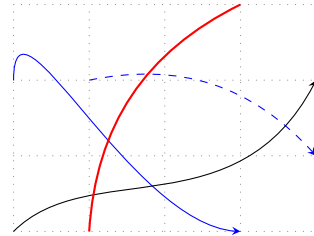

Adding text You can add text next to the line or curve of `\tzlink` by specifying the option `{<text1>}` followed by the optional argument `[<node opt1>]` between two coordinates (or after the option `[<code1>]` if it exists).

You can name the line or curve of `\tzlink` by specifying the optional arguments `{<text2>}` and `[<node opt2>]` after the second coordinate. The option `[<node opt2>]` is often for the position of node text at or around the second coordinate.

```

% \tzlink
\begin{tikzpicture}
\tzhelplines(4,3)
\tzlink[->](1,3){line A}(4,3)
\tzlink[blue](0,3){line B}[sloped](3,0){E}[r]
\tzlink[->,red](1,0){Start}[at start,1](4,2){Line C}[r]
\end{tikzpicture}

```

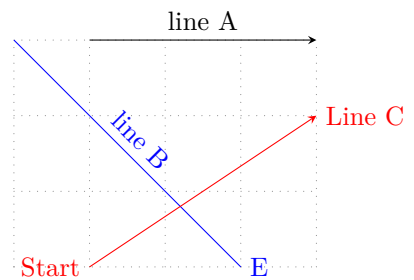

```

% \tzlink(+)
\begin{tikzpicture}
\tzhelplines(4,3)
\tzlink[->](0,0){A}(1,0)
\tzlink+[bend right](0,2){curve}[sloped](3,-2){End}[r]
\tzlink[->,auto](1,2)[-|]{B}(4,1){Goal!}[b,draw,blue]
\end{tikzpicture}

```

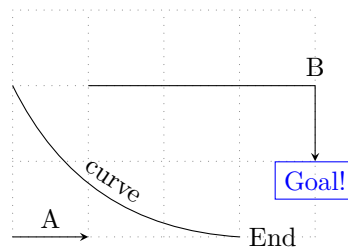

Shift You can move the line or curve by specifying the option `<shift coor>` before the first coordinate (or even before the option `"<path name>"` if it exists).

```

% \tzlink(+): shift
\begin{tikzpicture}
\tzhelplines(4,3)
\tzlink+[bend right](0,2)(3,-2){A}[r]
\tzlink+[bend right]<.5,.5>(0,2)(3,-2){A-shifted}[r]
\tzlink[->](1,2)[-|](4,1)
\tzlink[->,dashed]<-.2,.3>(1,2)[-|](4,1)
\end{tikzpicture}

```

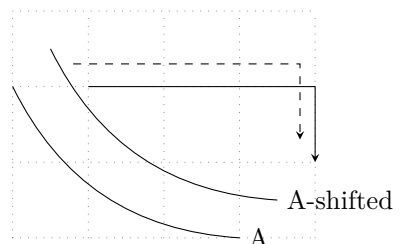

Naming paths: Intersections You can name the path of `\tzlink` by specifying the quote option "`<path name>`" *immediately before* the first coordinate. You can use the path names of two paths to find an intersection point.

```
% \tzlink(+): path name: intersection
\begin{tikzpicture}
\tzhelplines(4,3)
\tzlink[blue]"BB"(0,3){line B}[sloped](3,0)
\tzlink+[->,red,bend right]"CC"(1,0)(3,2){Line C}[r]
\tzXpoint{BB}{CC}(E) % intersection
\tzdot*(E){E}[a]
\end{tikzpicture}
```

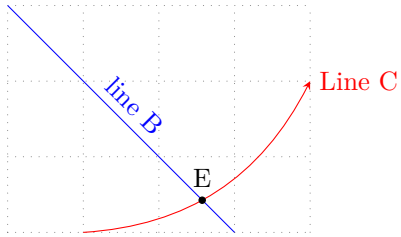

Extending paths You can extend the path of `\tzlink` by specifying TikZ code in the last optional argument `<code.append>`. You can also use the macros `\tzlinkAtBegin` and `\tzlinkAtEnd` to extend the path at the beginning and at the end, respectively. Specifying the option `<code.append>` extends the path after `\tzlinkAtEnd`.

```
% \tzlink(+): path name: intersection
\begin{tikzpicture}
\tzhelplines(4,3)
\tzlinkAtBegin{(1,1) to[bend left]}
\tzlinkAtEnd{arc (180:90:1cm) node [r,draw] {BB}}
\tzlink[blue]"BB"(0,3){line B}[sloped](3,0)
\tzlink+[->,red,bend right]"CC"(1,0)(3,2){Line C}[r]
< -| ++(-1,1) node [a] {End!} >
\tzXpoint{BB}{CC}(E)
\tzdot*(E){E}[a]
\end{tikzpicture}
```

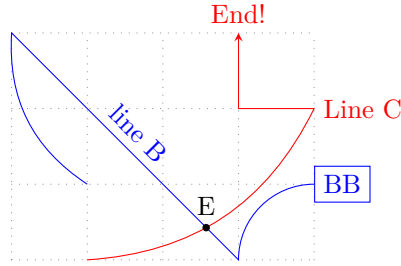

13.6 \tzlinks: All in one: Semicolon versions

13.6.1 \tzlinks: Standard version

The macro `\tzlinks` is a *semicolon version* of `\tzlink`. `\tzlinks` accepts any number of coordinates to connect them with connected line segments or curves. You can change how two adjacent points are connected. `\tzlinks` is quite *flexible* that you can think of it as a *generalized version* of `\tzlines`.

```
% syntax: minimum
\tzlinks (<coor>)(<coor> ..repeated.. (<coor>) ;
% syntax: full
\tzlinks{<path style>[<opt>]<shift coor>"<path name>"
(<coor>)[<code1>]{<text>}[<node opt>]<code2>
..repeated.. () [] {} [] <> ; {<fill opacity>} <code.append>
% remark:
- <code1> must be link style, such as --, to, -|, etc.
  (possibly followed by other code)
- <code2> is especially for + or ++
  (possibly with other code)
- repetition MUST be ended by ; (semicolon)
- full repeating pattern is () [] {} [] <> ..repeated.. () [] {} [] <>
- {<fill opacity>} works only in \tzlinks*
% defaults: \tzlinks, \tzlinks*, \tzlinks+, \tzlinks*+
{to} [] <>"" (<m>) [] {} [] <> ..repeated.. () [] {} [] <> ; { } <>
```

```

*{to}[fill=black!50,fill opacity=.3,text opacity=1]
  <>" (<m>){ } <> ..repeated.. (){} <> ; {.3}<>
+{to} <>" (<m>){ } <+> ..repeated.. (){} <> ; { }<>

```

How to change link styles There are three ways of changing link styles:

- The first curly brace option {<link style>} controls the link style of connecting any two coordinates.
- The second bracket option [<code1>] (locally) changes the link style of two adjacent coordinates. [<code1>] (locally) overrides {<link style>}
- The effect of the macro \settzlinkstyle remains until the end of tikzpicture environment, unless changed again.

```

% standard version
\tzlinks(1,1)(2,2)(3,1)(4,3); % works like:
\draw (1,1) to (2,2) to (3,1) to (4,3);

```

```

% \tzlinks
\begin{tikzpicture}
\tzhelplines(4,3)
\tzlinks(0,1)(1,2)(3,1)(4,3);
\end{tikzpicture}

```

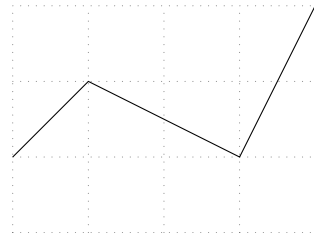

The default path style is to, which can be by \settzlinkstyle. The effect remains valid until the end of tikzpicture environment unless changed again.

```

% \tzlinks: \settzlinkstyle
\begin{tikzpicture}
\tzhelplines(4,3)
\settzlinkstyle{to[bend right]} %%
\tzlinks[dashed](0,1)(1,2)[-|](3,1)(4,3);
\tzlinks[blue]
(0,0)
(1,1)
(2,1)[to[out=-135,in=45]]
(3,0);
\end{tikzpicture}

```

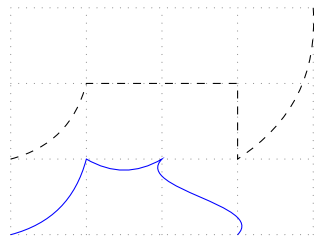

```

% \tzlinks: various link styles
\begin{tikzpicture}
\tzhelplines(4,3)
\tzlinks[->](1,2)[-|]
(0,0)[..controls (1,2) and (2,0)..]
(3,1)[to[bend left]]<+>
(1,2);
\end{tikzpicture}

```

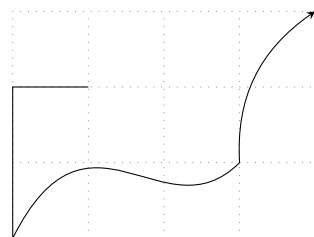

```

% \tzlinks: various link styles
\begin{tikzpicture}
\tzhelplines(4,3)
\tzlinks[->](1,1)<+>
            (1,1)[[rounded corners=10pt]--]
            (0,3)
            (0,0)[[sharp corners]--]
            (4,0)<+>
            (-1,2);
\end{tikzpicture}

```

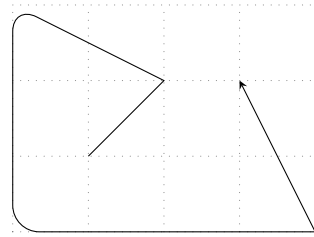

```

% \tzlinks: edge
\begin{tikzpicture}
\tzhelplines(4,3)
\tzlinks(0,1)(1,2)[edge[dashed]]<(3,1)>(3,1)(4,3);
\end{tikzpicture}

```

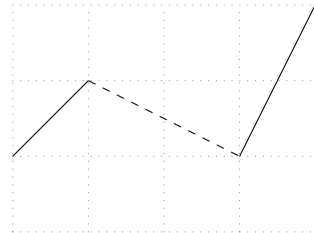

Remark: In TikZ, `edge` is not part of the main path. So you need to be careful when you move the path or find intersection points.

13.6.2 `\tzlinks+`, `\tzlinks*`, `\tzlinks*+`: Variants

The *plus version* `\tzlinks+` treats a coordinate as relative (with `++` by default) to the previous coordinate, except the first coordinate.

```

% plus (+) version
\tzlinks+(1,1)(2,2){--}(3,1)(4,3); % works like:
\draw (1,1) to ++(2,2) -- ++(3,1) to ++(4,3);

```

```

% \tzlinks+
\begin{tikzpicture}
\tzhelplines(4,3)
\tzlinks+(0,1)(1,1)[to[bend right]](2,-1)(1,2);
\end{tikzpicture}

```

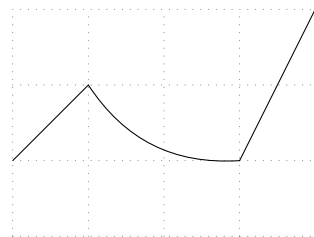

The *starred version* `\tzlinks*` is to fill the closed area formed by `\tzlinks` with color or pattern. The related default value is `[fill=black!50, fill opacity=.3, text opacity=1]`. In fact, `\tzlinks*[draw=none]` is (almost) the same as `\tzpath*` (See Section 14.2 on page 102 for more details).

```

% starred (*) version
\tzlinks*(1,1)(2,2)(3,1)(4,3); % works like:
\draw [fill=black!50,fill opacity=.3,text opacity=1]
      (1,1) to (2,2) to (3,1) to (4,3);

```

`\tzlinks*+` is the plus version of `\tzlinks*`.

```

% \tzlinks*+
\begin{tikzpicture}
\tzhelplines(4,3)
\tzlinks*+[thick](0,1)(1,1)[to[bend right]](2,-1)(1,2);
\end{tikzpicture}

```

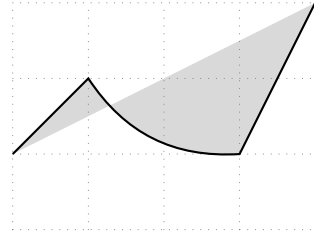

```

% \tzlinks: fill, fill opacity
\begin{tikzpicture}
\tzhelplines(4,3)
\tzline[red,very thick](0,3)(4,0)
\tzlinks[fill](0,0)(3,1)(2,3)(0,2); % default opacity=1
\tzlinks[fill=green,fill opacity=.5]
<1,-1>(0,0)(3,1)(2,3)(0,2);
\end{tikzpicture}

```

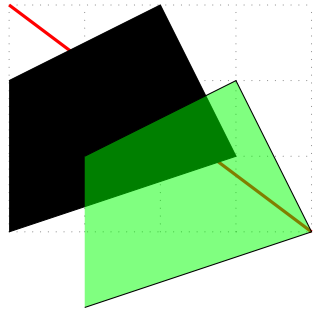

You can also change the fill opacity by specifying the *last* curly brace optional argument `{<fill opacity>}`, after the semicolon (or before the option `<code.append>` if it exists).

```

% \tzlinks*
\begin{tikzpicture}
\tzhelplines(4,3)
\settzfillcolor{green}
\tzline[red,very thick](0,3)(4,0)
\tzlinks*[blue](0,0)(3,1)(2,3)(0,2);{1}
\tzlinks*%[green]
<1,-1>(0,0)(3,1)(2,3)(0,2); {.5} %%
\end{tikzpicture}

```

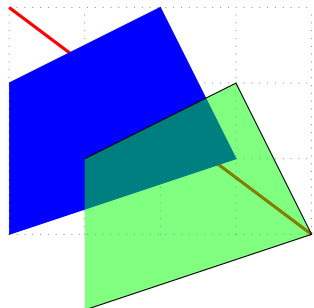

You can also use the macros `\settzfillcolor` and `\settzfillopacity` to change the defaults. The effect remains valid until the end of the `tikzpicture` environment, unless changed again.

13.6.3 Putting text, shift, intersections, and extending paths

Adding text You can add text next to connected line segment or around the last coordinate by specifying options `{<text>}[<node option>]`.

```

\tzlinks+[dashed]"AA"(1,1){A}(2,2)[--]{B}[a]<+>(3,1){C}[b]; % works like
\draw [dashed,name path=AA]
(1,1) to node {A}
++(2,2) -- node [above] {B}
+(3,1) to node [below] {C} ;

```

```

% \tzlinks: adding text
\begin{tikzpicture}
\tzhelplines(4,3)
\tzlinks[blue](0,0){Ace}
(1,1){Beth}[sloped,a]
(3,0){C} [near start]
(4,2){End!}[draw,a=3pt];
\end{tikzpicture}

```

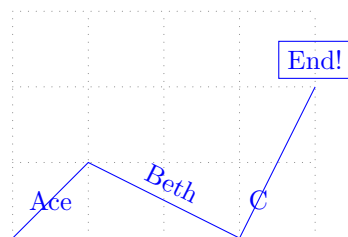

```

% \tzlinks: adding text
\begin{tikzpicture}
\tzhelplines(4,3)
\tzlinks[->](1,1){start}[sloped,b]<+>
(1,1)[[rounded corners=10pt]--]{K}[at end,a]
(0,3){Rounded}[scale=0.7,font=\scshape,at end,ar]
(0,0)[[sharp corners]--]
(4,0)<+>
(-1,2){End!}[draw,blue,a=3pt];
\end{tikzpicture}

```

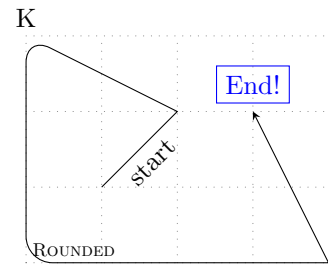

```

% \tzlinks: edge
\begin{tikzpicture}
\tzhelplines(4,3)
\tzlinks(0,1){start}[at start,b]
(1,2)[edge[dashed,bend right]]{Go!}[sloped,b]<(3,1)>
(3,1)
(4,3){End\\here!}[align=center,r,draw,red] ;
\end{tikzpicture}

```

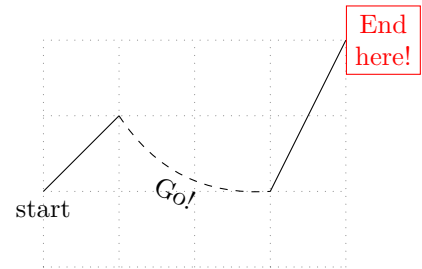

Remark: Note that `edge` is not part of the main path.

Shift You can move the path of `\tzlinks` with the option `<shift coor>`. An *empty* option `<>` is *not allowed*.

```

% \tzlinks:
\begin{tikzpicture}
\tzhelplines(4,3)
\tzlinks<.5,-1>(0,1){start}[at start,b] % shift
(1,2)[to[dashed,bend right]]{Go!}[sloped,b]
(3,1)
(4,3){End\\here!}[align=center,r,draw,red] ;
\end{tikzpicture}

```

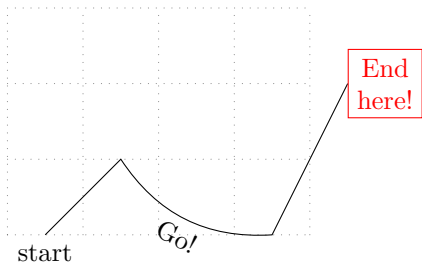

Naming paths: intersections You can name the path of `\tzlinks` *immediately before* the first coordinate and use it to find intersection points.

```

% \tzlinks: edge
\begin{tikzpicture}
\tzhelplines(4,3)
\tzlinks"AA"(0,1){start}[at start,b]
(1,2)[edge[dashed,bend right]]{Go!}[sloped,b]<(3,1)>
(3,1)
(4,3){End\\here!}[align=center,r,draw,red] ;
\tzhXpointat{AA}{1.5}{A} % horizontal intersections
\tzdots*(A){\texttt{(A)}}(A-2){\texttt{(A-2)}}[0];
\end{tikzpicture}

```

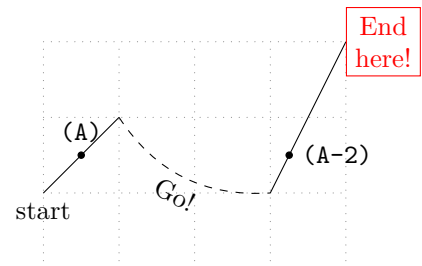

In the previous example, since `edge` is not part of the main path of `\tzlinks`, the second horizontal intersection point (A-2) is not on the `edge` curve.

Extending paths You can extend the path of `\tzlinks` by writing TikZ code in the last (after the semicolon) optional argument `<code.append>`. So `<--cycle>` closes the path with a straight line.

```

% \tzlinks* <code.append>
\begin{tikzpicture}
\tzhelplines(4,3)
\tzlinks*[blue] (0,1) (1,2) [-|] (3,1) (4,3);
    < to [bend right=60] (0,1) -- cycle >
\tzlinks*[fill=red]
    (0,0) [to[bend right]]
    (1,1)
    (2,1) [to[out=-135,in=45]]
    (3,0); % not closed
\end{tikzpicture}

```

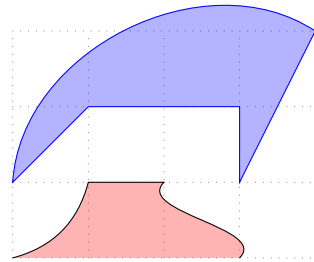

You can also use `\tzlinksAtBegin` and `\tzlinksAtEnd` to extend the path of `\tzlinks` at the beginning and at the end, respectively. Specifying the option `<code.append>` extends the path after `\tzlinksAtEnd`.

```

% \tzlinks*: extending paths
\begin{tikzpicture}
\tzhelplines(4,3)
\tzlinksAtBegin{(0,2) to[bend left]}
\tzlinksAtEnd{ to [out=210] (1,3) }
\tzlinks*[blue] (0,1) (1,2) [-|] (3,1) (4,3);
    < -| (0,2) >
\tzlinks*[fill=red]
    (0,0) [to[bend right]]
    (1,1)
    (2,1) [to[out=-135,in=45]]
    (3,0); <--cycle>
\end{tikzpicture}

```

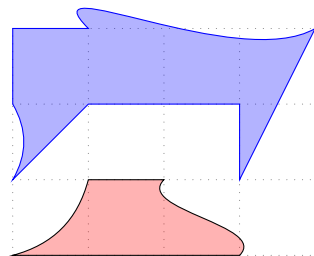

14 Filling Area

14.1 \tzpath: Semicolon version

The macro `\tzpath` is the same as `\tzlinks[draw=none]`. In other words, `\tzpath` creates a path connecting an arbitrary number of coordinates, but it does not stroke the path. Since `\tzpath` is a *semicolon version* macro, you need to enter a *semicolon* ‘;’ to indicate where the coordinate iteration ends.

You can visualize the path with `\tzpath[draw]`, which is the same as `\tzlinks`.

```

% syntax: minimal
\tzpath (<coor>)(<coor>) ..repeated.. (<coor>);
% syntax: full
\tzpath {<path style>}[<opt>]<shift coor>"<path name>"
    (<coor>)[<code1>]{<text>}[<node opt>]<code2>
    ..repeated.. () [] {} [] <> ; <code.append>
% remark:
- <code1> must be link style, such as --, to, -|, etc.
    (possibly followed by other codes)
- <code2> is especially for + and ++
    (possibly with other codes)
- repetition MUST be ended by ; (semicolon)
% defaults: \tzpath
{to} [] <> "" (<m>) [] {} [] <> ..repeated.. () [] {} [] <> ; <>

```

Remark:

- The main purpose of `\tzpath` is to fill an enclosed area with colors or patterns. You can use `\tzpath[fill]` or `\tzpath[pattern=<...>]` to do it.
- Use `\setztzpathlayer`, like `\setztzpathlayre{behind}`, to change the layer of `\tzpath` (default: main).

Path construction operation (If you are not an experienced user of TikZ just skip this part.)

`\tzpath` allows you to choose how to construct a path using the [`<path style>`] option *in-between* coordinates. *Path extension operation* can be selected from ‘`--`’, ‘`to`’, ‘`|-`’, ‘`-|`’, etc. You can use *the first brace option* {`<path style>`} to change all the `<path style>` in-between coordinates.

```
% \tzpath: path construction
\begin{tikzpicture}
\tzhelplines(4,3)
\tzpath[draw](0,1)(1,2)[-|](3,1)(4,3);
\tzpath[draw]
  (0,0)[to[bend right]]
  (1,1)
  (2,1)[to[out=-135,in=45]]
  (3,0);
\end{tikzpicture}
```

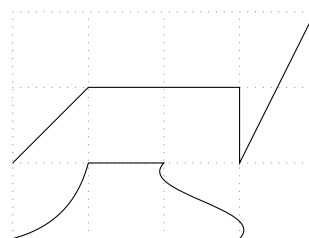

The default path style is ‘`to`’ and can also be changed by `\setztzpathstyle`, like, for example, `\setztzpathstyle{--}`. `\setztzpathstyle` is an alias of `\setztzlinkstyle`. The effect remains valid until the end of `tikzpicture` environment unless changed again.

```
% \tzpath: \setztzpathstyle
\begin{tikzpicture}
\tzhelplines(4,3)
\setztzpathstyle{to[bend right]}
\tzpath[draw](0,1)(1,2)[-|](3,1)(4,3);
\tzpath[draw]
  (0,0)[to[bend right]]
  (1,1)
  (2,1)[to[out=-135,in=45]]
  (3,0);
\end{tikzpicture}
```

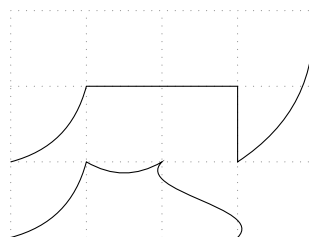

```
% \tzpath: \setztzpathstyle
\begin{tikzpicture}
\tzhelplines(4,3)
\setztzpathstyle{to[bend right]}
\tzlinks(0,1)(1,2)[-|](3,1)(4,3);
\tzlinks
  (0,0)[to[bend right]]
  (1,1)
  (2,1)[to[out=-135,in=45]]
  (3,0);
\end{tikzpicture}
```

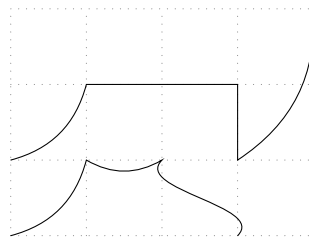

You can extend the path of `\tzpath` by writing TikZ code in the last (after the semicolon) optional argument `<code.append>`. So `<--cycle>` closes the path with a straight line.

```

% \tzpath: <code.append>
\begin{tikzpicture}
\tzhelplines(4,3)
\tzpath[draw](0,1)(1,2)[-|](3,1)(4,3);
    < to [bend right=60] (0,1) >
\tzpath[fill]
    (0,0)[to[bend right]]
    (1,1)
    (2,1)[to[out=-135,in=45]]
    (3,0); <--cycle>
\end{tikzpicture}

```

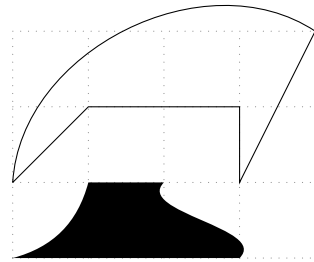

14.2 \tzpath*: Semicolon version

The starred version `\tzpath*` is the (almost) same as `\tzlinks*[draw=none]`. It fills the interior of `\tzpath` with `fill=black!50` with `fill opacity=.3` and `text opacity=1`, by default. The only difference between `\tzpath*` and `\tzlinks*[draw=none]` is that the layer of `\tzpath*` can be changed by `\setztzpathlayer`, like `\setztzpathlayer{behind}`.

`\tzpath*` works like `\tzpath[fill=black!50,fill opacity=.3,text opacity=1]`. You can change the defaults by `\setztzfillcolor` and `\setztzfillopaicity`.

```

% syntax: minimal
\tzpath*(<coor>)(<coor>) ..repeated.. (<coor>) ; {<fill opacity>}
% syntax: full
\tzpath*{<path style>}[<opt>]<shift coor>"<path name>"
    (<coor>)[<code1>]{<text>}[<node opt>]<code2>
    ..repeated.. () [] {} [] <> ; {<fill opacity>} <code.append>
% remark:
- <code1> must be link style, such as --, to, -|, etc.
    (possibly followed by other codes)
- <code2> is especially for + and ++
    (possibly with other codes)
- repetition MUST be ended by ; (semicolon)
% defaults: \tzpath*
*{to}[fill=black!50,fill opacity=.3,text opacity=1]<>"
    (<m>) [] {} [] <> ..repeated.. () [] {} [] <> ; {.3}<>

```

Filling the interior You can optionally change the opacity of fill color using the TikZ option `fill opacity`.

```

% \tzpath: fill, fill opacity
\begin{tikzpicture}
\tzhelplines(4,3)
\tzline[red,very thick](0,3)(4,0)
\tzpath[fill](0,0)(3,1)(2,3)(0,2); % default opacity=1
\tzpath[fill,green,fill opacity=.5]
    <1,-1>(0,0)(3,1)(2,3)(0,2);
\end{tikzpicture}

```

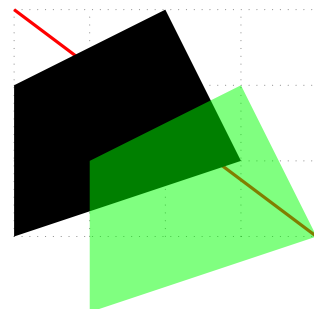

You can also change the fill opacity by specifying the *last* curly brace optional argument `{<fill opacity>}`, *after the semicolon*.

```

% \tzpath*
\begin{tikzpicture}
\tzhelplines(4,3)
\tzline[red,very thick](0,3)(4,0)
\tzpath*(0,0)(3,1)(2,3)(0,2);
\tzpath*[green]
<1,-1>(0,0)(3,1)(2,3)(0,2); {.5} %%
\end{tikzpicture}

```

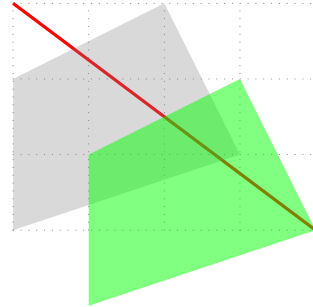

You can also use the macros `\settzfillcolor` and `\settzfillopacity` to change the defaults. The effect remains valid until the end of the `tikzpicture` environment, unless changed again.

```

% \tzpath*: \settzfillcolor
\begin{tikzpicture}
\tzhelplines(4,3)
\settzfillcolor{red}
\tzpath*[blue](0,1)(1,2)[-|](3,1)(4,3);
< to [bend right=60] (0,1) >
\tzpath*
(0,0)[to[bend right]]
(1,1)
(2,1)[to[out=-135,in=45]]
(3,0); <--cycle>
\end{tikzpicture}

```

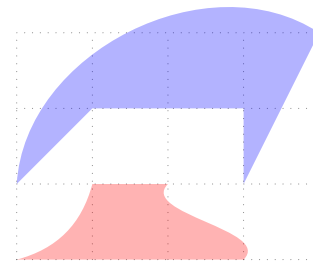

14.3 `\tzpath+` and `\tzpath*+`: Relative coordinates: Semicolon versions

The *plus version* `\tzpath+` uses each coordinate (except for the first coordinate) relative (with `++`) to the previous coordinate.

Everything else is the same as in `\tzpath`.

`\tzpath*+` is simply the plus version of `\tzpath*`.

```

% \tzpath+
\begin{tikzpicture}
\tzhelplines(4,3)
\tzline[red,very thick](0,3)(4,0)
\tzpath+[pattern=bricks,preaction={fill=brown}]
(0,0)(3,1)(-1,2)(-2,-1);
\tzpath+[pattern=north east lines,opacity=.5]
<1,-1>(0,0)(3,1)(-1,2)(-2,-1);
\end{tikzpicture}

```

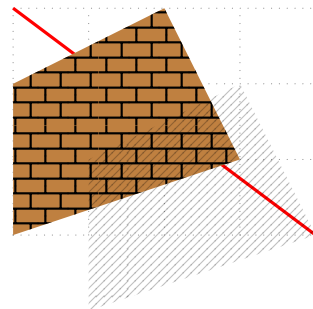

You can change the layer (main by default) using `\settzpathlayer`.

```

% \settzpathlayer
\begin{tikzpicture}
\tzhelplines(4,3)
\settzpathlayer{behind} %% layer
\tzline[red,very thick](0,3)(4,0)
\tzpath+[pattern=bricks,preaction={fill=brown}]
(0,0)(3,1)(-1,2)(-2,-1);
\tzpath+[pattern=north east lines,opacity=.5]
<1,-1>(0,0)(3,1)(-1,2)(-2,-1);
\end{tikzpicture}

```

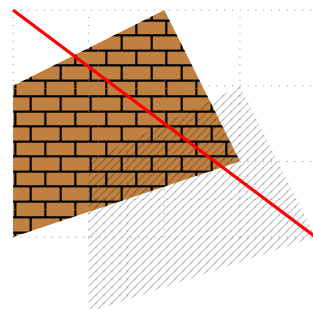

```

% \tzpath**
\begin{tikzpicture}
\tzhelplines(4,3)
\tzline[red,very thick](0,3)(4,0)
\tzpath**+(0,0)(3,1)(-1,2)(-2,-1);
\tzpath**+[fill=green]
  <1,-1>(0,0)(3,1)(-1,2)(-2,-1); {.5} %%
\end{tikzpicture}

```

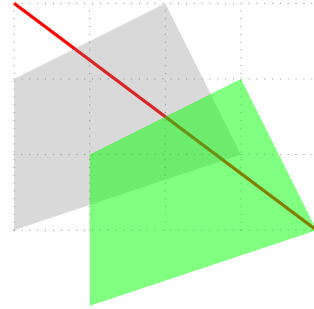

15 Curves

There are many ways to draw curves.

15.1 Bézier curves

15.1.1 \tzbezier

\tzbezier accepts *three or four* coordinates to draw a Bézier curve from the first coordinate to the last coordinate, with *one or two* control points.

```

% syntax: minimal
\tzbezier(<start-coor>)(<ctl-coor>)(<last-coor>)
\tzbezier(<start-coor>)(<ctl-coor>)(<ctl-coor>)(<last-coor>)
% syntax: full
\tzbezier[<draw opt>]<shift coor>"<name path>"
  (<start-coor>)(<ctl-coor>)(<ctl-coor>)(<last-coor>)
  {<text>}[<node opt>]<code.append>
% defaults
[]<>"(<m>)(<m>)(<m>){}<>

```

Control points You can specify one or two control points, (<ctl-coor>).

```

% three coordinates: one control point
\tzbezier(0,1)(1,0)(4,3) % works like:
\draw (0,0) ..controls (1,0).. (4,3);

```

```

% four coordinates: two control points
\tzbezier(0,1)(1,0)(2,4)(4,3) % works like:
\draw (0,0) ..controls (1,0) and (2,4).. (4,3);

```

```

% \tzbezier
\begin{tikzpicture}
\tzhelplines(4,4)
\tzbezier[red](0,3)(1,2)(2,4)(4,3)
\tzbezier[blue](0,2)(1,.5)(4,0)
\end{tikzpicture}

```

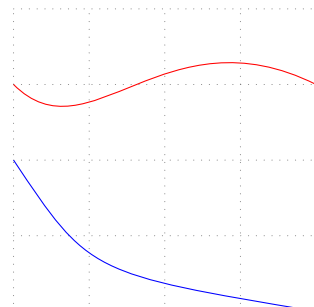

The style `tzshowcontrols` displays the control points by drawing dotted lines, by default. You can also change the dotted line style, like `tzshowcontrols={dashed,green}`.

```

% \tzbezier: tzshowcontrols
\begin{tikzpicture}
\tzhelplines(4,4)
\tzbezier[blue,tzshowcontrols](0,2)(1,.5)(4,0)
\tzdots*[blue](0,2)(1,.5)(4,0);
\tzbezier[red,tzshowcontrols={green,dashed}]
(0,3)(1,2)(2,4)(4,3)
\tzdots*[red](0,3)(1,2)(2,4)(4,3);
\end{tikzpicture}

```

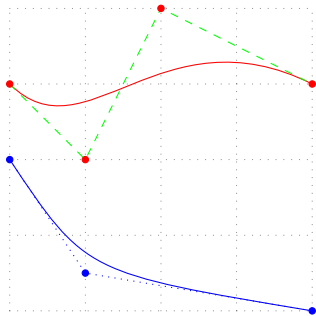

Adding text You can add text next to the curve or at the last coordinate by specifying the options `{<text>}` and `[<node opt>]` immediately after the last coordinate.

```

% \tzbezier: adding text
\begin{tikzpicture}
\tzhelplines(4,4)
\tzbezier[blue](0,2)(1,.5)(4,0){curve}[draw,black,r]
\tzbezier[red](0,3)(1,2)(2,4)(4,3){bezier}[near end,a]
\end{tikzpicture}

```

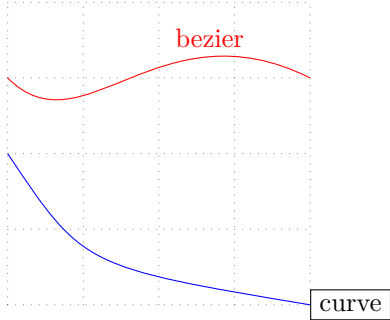

Shift You can move the curve of `\tzbezier` by specifying the option `<shift coor>` before the first coordinate or immediately before the option `"<path name>"`, if it exists. The *empty* shift option `<>` is *not allowed*.

```

% \tzbezier: shift
\begin{tikzpicture}
\tzhelplines(4,4)
\tzbezier[blue]
(0,2)(1,.5)(4,0){curve}[draw,black,r]
\tzbezier[blue,dashed]
<1,1>(0,2)(1,.5)(4,0){curve}[r]
\tzbezier[red]
(0,3)(1,2)(2,4)(4,3){bezier}[near end,a]
\tzbezier[red,dashed]
<0,-1>(0,3)(1,2)(2,4)(4,3){bezier}[blue,near end,a]
\end{tikzpicture}

```

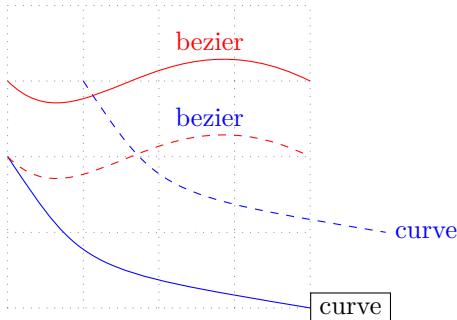

Naming paths: intersections You can name the path of `\tzbezier` by specifying the option `"<path name>"` immediately before the first coordinate.

```

% \tzbezier: name path, intersection
\begin{tikzpicture}
\tzhelplines(4,4)
\tzbezier[blue,dashed,thick]<1,1>"curve"
(0,2)(1,.5)(4,0){curve}[r]
\tzbezier[red,dashed,thick]<0,-1>"bezier"
(0,3)(1,2)(2,4)(4,3){bezier}[blue,near end,a]
% intersection point
\tzXpoint*{curve}{bezier}(X){X}[-90]
\end{tikzpicture}

```

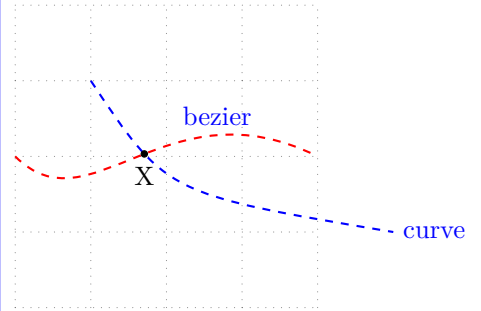

Extending paths You can extend the path of `\tzbezier` from the last coordinate, by writing TikZ code in the last optional argument `<code.append>`.

```

% \tzbezier: extending path
\begin{tikzpicture}
\tzhelplines(4,4)
\tzbezier[red](0,3)(1,2)(2,4)(4,3){bezier}[near end,a]
< to [bend right] ++(-1,-1) node [below] {A} >
\tzbezier[blue,->](0,2)(1,.5)(4,0)
< |- ++(-2,1) node [below] {B} >
\end{tikzpicture}

```

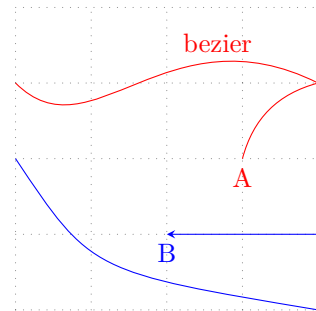

You can also use `\tzbezierAtBegin` and `\tzbezierAtEnd` to extend the path of `\tzbezier` at the beginning and at the end, respectively. Specifying the option `<code.append>` extends the path after `\tzbezierAtEnd`.

```

% \tzbezier: extending path
\begin{tikzpicture}
\tzhelplines(4,4)
\tzbezierAtEnd
{ to [bend right] ++(-1,-1) node [below] {A} }
\tzbezier[red](0,3)(1,2)(2,4)(4,3){bezier}[near end,a]
\tzbezierAtBegin{ (0,0) to [out=45,in=-30] }
\tzbezierAtEnd{ |- ++(-2,1) }
\tzbezier[blue,->](0,2)(1,.5)(4,0){B}[b]
< arc (0:90:1) node [a] {End!} >
\end{tikzpicture}

```

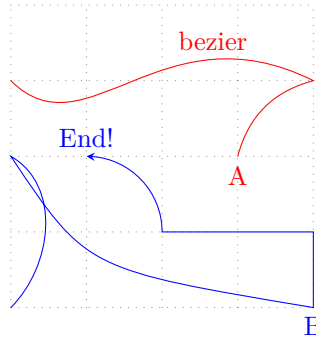

15.1.2 `\tzbezier+`: Relative coordinates

For the *plus version* `\tzbezier+`, the last coordinate is *relative* to the first coordinate. And the first control point is *relative* to the first coordinate.

```

% three coordinates
\tzbezier+(0,1)(1,-1)(4,3) % works like:
\draw (0,1) ..controls +(1,-1).. ($ (0,1)+(4,3) $);

```

In TikZ, the second control point is *relative* to the last coordinate.

Therefore, for `\tzbezier+(A)(B)(C)(D)`, (B) and (D) are *relative* to (A), and the second control point (C) is *relative* to the last coordinate (D).

```

% four coordinates
\tzbezier+(0,1)(1,-1)(-2,1)(4,3) % works like:
\draw (0,1) ..controls +(1,-1) and +(-2,1).. ($ (0,1)+(4,3)$);

```

```

% \tzbezier+
\begin{tikzpicture}
\tzhelplines(4,4)
\tzbezier+(0,3)(1,-1)(-2,1)(4,0){bezier}[near end,a]
< to [bend right] ++(-1,-1) node [below] {A} >
\tzbezier+[blue,->](0,2)(1,-1.5)(4,-2)
< |- ++(-2,1) node [above] {B} >
\end{tikzpicture}

```

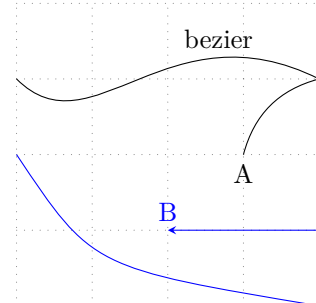

```

% \tzbezierAtBegin, \tzbezierAtEnd
\begin{tikzpicture}
\tzhelplines(4,4)
\tzbezierAtEnd
{ to [bend right] ++(-1,-1) node [below] {A} }
\tzbezier+(0,3)(1,-1)(-2,1)(4,0){bezier}[near end,a]
\tzbezierAtBegin{ (1,0) to [out=150,in=30] }
\tzbezierAtEnd{ |- ++(-2,1) node [a] {here!} }
\tzbezier+[blue,->](0,2)(1,-1.5)(4,-2){B}[b]
\end{tikzpicture}

```

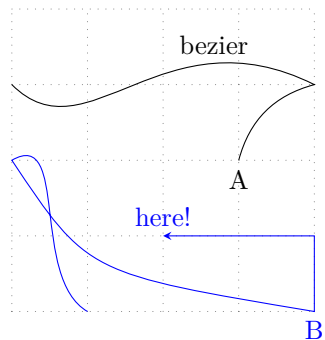

15.2 Parabolas

15.2.1 \tzparabola

\tzparabola accepts *two or three* coordinates to draw a parabola from the first coordinate to the last coordinate. In the case of three coordinates, the parabola bends at the second coordinate.

```

% two coordinates
\tzparabola(0,0)(3,2) % works like:
\draw (0,0) parabola (3,2);

```

```

% three coordinates
\tzparabola(0,0)(1,1)(3,2) % works like:
\draw (0,0) parabola bend (1,1) (3,2);

```

```

% syntax: minimal
\tzparabola(<coor>)(<coor>)
\tzparabola(<coor>)(<coor>)(<coor>)
% syntax: full
\tzparabola[<opt1>]<shift coor>"<path name>"
(<coor>)(<coor>)(<coor>){<text>}[<node opt>]<code.append>
% default
[]<>"(<m>)( )(<m>){}[]<>

```

Parabolas `\tzplot` draws the graph of a quadratic function $f(x) = ax^2 + bx + c$ for appropriate values of a , b , and c .

```

% \tzparabola: two coordinates
\begin{tikzpicture}
\tzhelplines(4,3)
\tzparabola[thick](0,0)(2,2)
\tzparabola[bend at end,dashed](0,0)(2,2)
\tzparabola[red,thick,bend pos=.5](2,0)(4,3)
\tzparabola[blue,parabola height=-2cm](2,3)(4,2)
\end{tikzpicture}

```

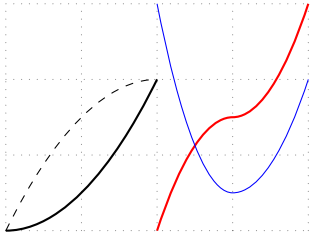

```

% \tzparabola: three coordinates
\begin{tikzpicture}
\tzhelplines(4,3)
\tzparabola[thick](0,2)(1,0)(2,2)
\tzparabola[blue](0,3)(2,1)(4,2)
\tzparabola[red,thick](2,0)(3,2)(4,3)
\end{tikzpicture}

```

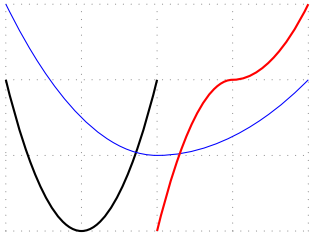

Adding text You can add text at or around the *last coordinate* by specifying the options `{<text>}` and `[<node opt>]` immediately after the last coordinate.

```

% \tzparabola: adding text
\begin{tikzpicture}
\tzhelplines(4,3)
\tzparabola[thick](0,0)(2,2){parabola}[blue,draw,a]
\tzparabola[blue](0,3)(2,1)(4,2){AC}[r]
\tzparabola[red,thick,bend pos=.5](2,0)(4,3){C}[ar]
\end{tikzpicture}

```

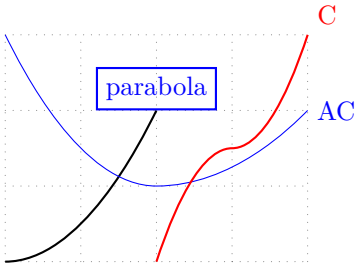

Shift You can move the parabola by specifying the option `<shift coor>` before the first coordinate or immediately before the option "`<path name>`", if it exist. The *empty* shift option `<>` is *not allowed*.

```

% \tzparabola: shift
\begin{tikzpicture}
\tzhelplines(4,3)
\tzparabola[blue](0,3)(2,1)(4,2){AC}[r]
\tzparabola[dashed]<0,-.5>(0,3)(2,1)(4,2){AC}[r]
\tzparabola[dotted]<0,-1>(0,3)(2,1)(4,2){AC}[r]
\end{tikzpicture}

```

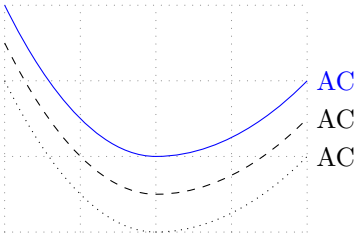

Naming paths: intersections You can name the path of `\tzparabola` by specifying the option "`<path name>`" immediately before the first coordinate.

```

% \tzparabola: name path, intersection
\begin{tikzpicture}
\tzhelplines(4,3)
\tzparabola[blue]"AC"(0,3)(2,1)(4,2){AC}[r]
\tzparabola"BB"(1,0)(2,2)(3,0)
% intersection points
\tzXpoint*{AC}{BB}(X)
\tzdot(X-2)(3pt)
\end{tikzpicture}

```

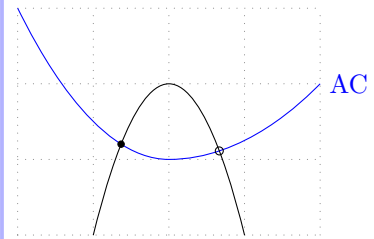

Extending paths You can extend the path of `\tzparabola` from the last coordinate by writing TikZ code in the last optional argument `<code.append>`.

```

% \tzparabola: extending path
\begin{tikzpicture}
\tzhelplines(4,3)
\tzparabola[blue,->]"AC"(0,3)(2,1)(4,2)
< -- ++ (-1,1) >
\tzparabola"BB"(1,0)(2,2)(3,0)
< -| ++ (1,1) node [right] {K!} >
\end{tikzpicture}

```

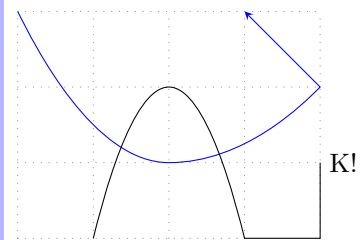

You can also use the macros `\tzparabolaAtBegin` and `\tzparabolaAtEnd` to extend the path of `\tzparabola` at the beginning and at the end, respectively. Specifying the option `<code.append>` extends the path after `\tzparabolaAtEnd`.

```

% \tzparabola: extending path
\begin{tikzpicture}
\tzhelplines(4,3)
\tzparabolaAtEnd{ -- ++ (-1,1) }
\tzparabola[blue,->]"AC"(0,3)(2,1)(4,2)
\tzparabolaAtBegin{ (0,1) to [bend right] }
\tzparabolaAtEnd{ -| ++ (1,1) node [right] {End!} }
\tzparabola"BB"(1,0)(2,2)(3,0){K!}[b1]
< arc (-90:0:1) node [a] {here!} >
\end{tikzpicture}

```

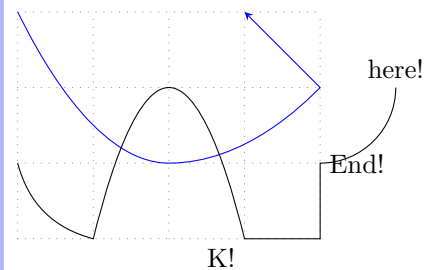

15.2.2 `\tzparabola+`: Relative coordinates

The *plus version* `\tzparabola+` uses the second and the third coordinates *relative* to the first coordinate.

Everything else is the same as in `\tzparabola`.

```

% two coordinates
\tzparabola+(0,1)(1,2) % works like:
\draw (0,1) parabola ($(0,1)+(1,2)$);

```

```

% three coordinates
\tzparabola+(0,1)(1,1)(3,-1) % works like:
\draw (0,1) parabola bend +(1,1) ($(0,1)+(3,-1)$);

```

```

% \tzparabola+
\begin{tikzpicture}
\tzhelplines(4,3)
\tzparabola+[thick] (0,0) (2,2){parabola}[blue,draw,a]
\tzparabola+[blue] (0,3) (2,-2) (4,-1){AC}[r]
\tzparabola+[red,thick,bend pos=.5] (2,0) (2,3){C}[ar]
\end{tikzpicture}

```

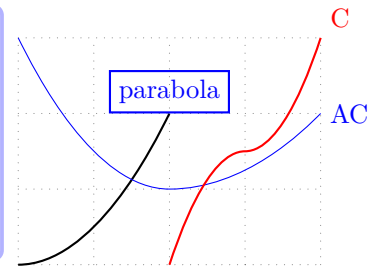

15.3 Edges

15.3.1 \tzedge(+)

The macro `\tzedge` connects two coordinates with a straight or curved line, using the TikZ edge operation.

```

% syntax
\tzedge[<opt>]<shift coor>
  (<coor>){<text>}[<opt>] (<coor>){<text>}[<opt>]<code.append>
% defaults
[] <> (<m>){} [] (<m>){} [] <>

```

Remark: In TikZ, the edge operation works like the `to` operation, but it is independently drawn after a main path is drawn and does not form a main path. So the option "`<path name>`" (for finding intersections) is not provided in `\tzedge`.

```

\tzedge(1,1)(3,2) % works like:
\draw (1,1) edge (3,2);

```

```

\tzedge[->,bend right](1,1){A}[near start](3,2) % works like:
\draw (1,1) edge [->,bend right] node [near start] {A} (3,2);

```

```

% \tzedge
\begin{tikzpicture}
\tzhelplines(4,3)
\tzedge[->] (0,1) (2,3)
\tzedge[out=0,dashed]
  (0,0){edge}[near start,sloped,a] (4,2)
\tzedge[in=90,blue] (2,0) (4,1){C}[r]
\end{tikzpicture}

```

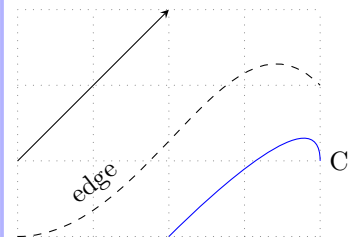

The *plus version* `\tzedge+` use the second coordinate *relative* to the first coordinate.

```

\tzedge+(1,1)(3,2) % works like:
\draw (1,1) edge ++(3,2);

```

```

\tzedge+[->,bend right](1,1){A}[near start](3,2){B}[right] % works like:
\draw (1,1) edge [->,bend right] node [near start] {A} ++(3,2)

```

```
++(3,2) node [right] {B};
```

```
% \tzedge+: shift
\begin{tikzpicture}
\tzhelplines(4,3)
\tzedge+[->](0,1)(2,2)
\tzedge+[out=0,dashed]
(0,0){edge}[near start,sloped,a](4,2)
\tzedge+[in=90,blue]<-.5,.5>(2,0)(2,1){shifted}[b,draw]
\end{tikzpicture}
```

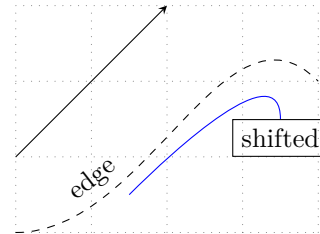

Remark: `edge` in the option `<code.append>` works with the second coordinate, but it works with the last node if the second option `{<text>}` is not empty. (In *TikZ*, if `edge` is preceded by `node`, the node is its start point.)

```
% <code.append>
\begin{tikzpicture}
\tzhelplines(4,3)
\tzedge[->](0,1)(2,3)<edge[bend left,red] ++(1,-2)>
\tzedge[out=0,dashed]
(0,0){edge}[near start,sloped,a]
(4,2){A}[draw]
<edge[bend left,thick] ++ (-1,-2)>
\end{tikzpicture}
```

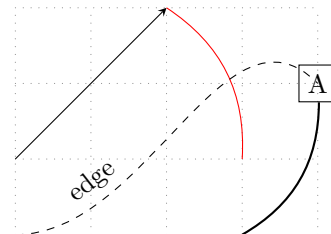

15.3.2 \tzedges(+): Semicolon versions

The macro `\tzedges` accepts any number of coordinates to draw edges from the first coordinate to each of the next using the *TikZ* `edge` operation. That is, the first coordinate is the unique start coordinate, and all others are target coordinates. `\tzedges` is a semicolon version, so you need to type `;` to indicate when the coordinate iteration ends.

```
% syntax: minimum
\tzedges(<coor>(<coor>)..repeated..(<coor>);
% syntax: full
\tzedges[<opt>]<shift coor>
(<coor>)[<edge opt>]{<text>}[<opt>]..repeated..() []{}[] ; <code.append>
% defaults
[] (<m>) []{}[] ..repeated..() []{}[];
```

Remark: In *TikZ*, the `edge` operation works like `to` operation, but it is added after main path is formed, like `node` does.

- Each `edge` is drawn independently from a main path as well as any other `edge`'s. (See *TikZ* manual for more details.)
- The `edge` operation of *TikZ* does not change anything about a main path, so the current point is not changed by `\tzedges`. This means that the last node (with `{<text>}` and `[<node opt>]`) works with the first (namely, start) coordinate.

```

% \tzedges
\begin{tikzpicture}
\tzhelplines(4,3)
\tzedges(0,1){A} (1,2)
[blue,thick]{edge}[b] (3,1)
(4,3);
\end{tikzpicture}

```

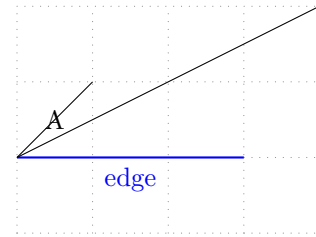

```

\tzedges(0,1){A}(1,2)[blue,thick]{edge}[a](3,1)(4,3); % works like
\draw (0,1) edge node {A} (1,2)
edge [blue,thick] node [above] {edge} (3,1)
edge (4,3);
\end{tikzpicture}

```

```

% \tzedges: shift
\begin{tikzpicture}
\tzhelplines(4,3)
\tzedges[bend right]<1,-1> % shift
(0,1)[->,thick,blue]{A}
(1,2)[dotted]{Beta}[b]
(3,1)[dashed]{Cate}[near end,sloped,a]
(4,3);
\end{tikzpicture}

```

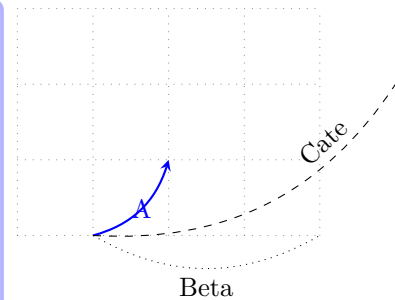

The *plus version* `\tzedges+` uses the second and next coordinates *relative* to the first coordinate.

```

\tzedges+(0,1)(2,1)(3,0)(4,2); % works like
\draw (0,1) edge ++ (2,1)
edge ++ (3,0)
edge ++ (4,2);

```

```

% \tzedges+
\begin{tikzpicture}
\tzhelplines(4,3)
\tzedges+[bend right](0,1)[bend right=0]{A}
(1,1)[dotted]{Beta}[b]
(3,0)[dashed]{Cate}[near end,sloped,a]
(4,2);
\end{tikzpicture}

```

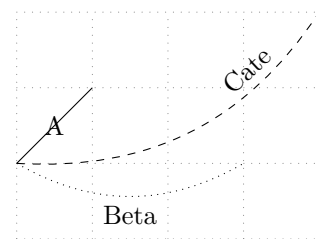

Remark: The option `<code>.append</code>` works with the first coordinate because `edge` and `node` do not change the current point.

```

% <code.append>
\begin{tikzpicture}
\tzhelplines(4,3)
\tzedges+(0,1)[bend right=0,->]{A}[fill=white]
(1,1)[bend right,dotted]{Beta}[midway]
(3,0)[bend right,dashed]{Cate}[near end]
(4,2);
< edge [bend left,thick,blue] (1,3) >
\end{tikzpicture}

```

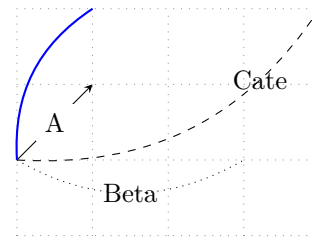

15.4 More curves

15.4.1 \tzplotcurve, \tzplot

You can draw curves with `\tzplotcurve` and `\tzplot`.

```

% \tzplotcurve(*)
\begin{tikzpicture}
\tzhelplines(4,3)
\tzplotcurve*[red,text=blue]
(0,0)(1,2){B}(2,2)(3,3)(4,1){E}[0];
\tzplotcurve(1,.5)(2,3)(3,2)(2,1)(3,1);
\end{tikzpicture}

```

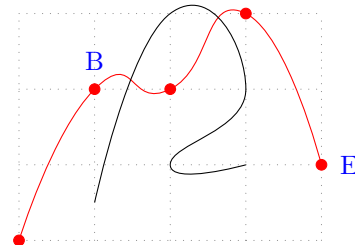

See Section 10.6 on page 64, for more details on `\tzplotcurve`.

See Section 10.1 on page 58, for more details on `\tzplot`.

15.4.2 \tzto, \tztos

You can draw curves with `\tzto` and `\tztos`. `\tztos` are quite useful to draw various curves.

```

% \tztos
\begin{tikzpicture}
\tzhelplines(4,3)
\tzcoors*(0,0)(A)(1,2)(B){B}[b](3,3)(C)(4,2)(D);
\tzto(A)[out=80,in=180]
(B)[out=0,in=180]
(C)[out=0,in=180]
(D){End!}[r];
\end{tikzpicture}

```

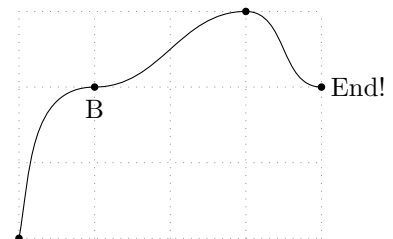

See Section 13.1 on page 87, for more details on `\tzto`.

See Section 13.3 on page 89, for more details on `\tztos`.

15.4.3 \tzlink, \tzlinks

You can also draw curves with `\tzlink` and `\tzlinks`.

```

% \tztos
\begin{tikzpicture}
\tzhelpelines(4,3)
\tzcoors*(0,0)(A)(1,2)(B){B}[b](3,3)(C)(4,2)(D);
\tzlinks(A)[to[out=80,in=180]]
          (B)[to[out=0,in=180]]
          (C)[to[out=0,in=180]]
          (D){End!}[r];
\end{tikzpicture}

```

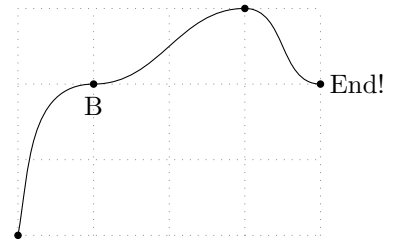

See Section 13.5 on page 92, for more details on `\tzlink`.

See Section 13.5 on page 95, for more details on `\tztos`.

15.4.4 `\tzfn`

With `\tzfn`, you can plot functions such as $f(x) = \frac{1}{3}(x-1)^3 + 1$, $g(x) = \sin x$, $h(x) = \sqrt{x-1}$, and so on. See Section 21.1 on page 153, for more details on `\tzfn`.

16 Polygons and Circles

16.1 Polygons: `\tzpolygon`: Semicolon versions

16.1.1 `\tzpolygon`

`\tzpolygon` connects an arbitrary number of coordinates to draw a polygon, a closed figure. `\tzpolygon` is equivalent to a *closed* `\tzlines`. Since `\tzpolygon` is a *semicolon version*, you need to enter a *semicolon* to indicate when the coordinate repetition ends.

```
% syntax: minimum
\tzpolygon(<coor>)(<coor>)..repeated..(<coor>) ;
% syntax: medium
\tzpolygon (<coor>){<text>}[<node opt>]..repeated..(<coor>){<text>}[<node opt>] ;
% syntax: full
\tzpolygon[<opt>]<shift coor>"<path name>"
    (<coor>){<text>}[<node opt>]
    ..repeated.. (){}[] ; <code.append>
% defaults
[]<>"(<m>){}[] ..repeated.. (){}[] ; <>
```

```
\tzpolygon(1,1)(2,2)(3,1)(4,3); % works like:
\draw (1,1) -- (2,2) -- (3,1) -- (4,3) -- cycle;
```

You can add text next to lines by specifying the options `{<text>}` and `[<node opt>]` *in-between* coordinates.

```
% \tzpolygon
\begin{tikzpicture}
\tzhelplines(4,3)
\tzpolygon[fill,blue,auto]
    (0,1){Side A}[sloped,red]
    (1,3){B}
    (2,3)
    (3,2){Side D}[swap,sloped]
    (1,0);
\end{tikzpicture}
```

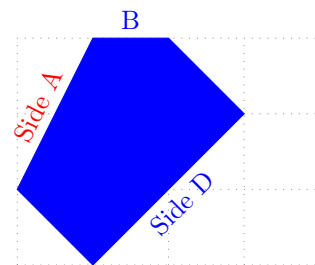

You can also move the polygon by specifying the option `<shift coor>` before the first coordinate. The *empty* shift option `<>` is *not allowed*.

```
% \tzpolygon: shift
\begin{tikzpicture}
\tzhelplines(4,3)
\tzpolygon[blue,auto]
    (0,1){Side A}[sloped,red]
    (1,3){B}
    (2,3)
    (3,2){Side D}[swap,sloped]
    (1,0);
\tzpolygon[auto,dashed]<1,-.5>
    (0,1)(1,3)(2,3){C}(3,2)(1,0);
\end{tikzpicture}
```

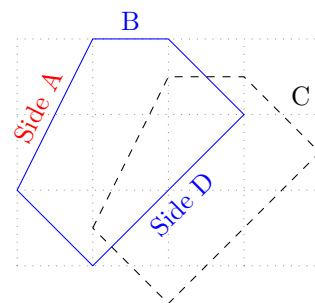

16.1.2 \tzpolygon*

The starred version `\tzpolygon*` paints the interior of the polygon with the default options `fill=black!50` with `fill opacity=.3` and `text opacity=1`.

```
% syntax: minimum
\tzpolygon*(<coor>)(<coor>)..repeated..(<coor>) ;
% syntax: medium
\tzpolygon*(<coor>){<text>}[<node opt>]..repeated..(<coor>){<text>}[<node opt>] ;
% syntax: full
\tzpolygon* [<opt>] <shift coor> "<path name>"
    (<coor>){<text>}[<node opt>]
    ..repeated.. (){}[] ; {<fill opacity>} <code.append>
% defaults
*[fill=black!50,fill opacity=.3,text opacity=1]<>"
(<m>){}[] .. repeated.. (){}[] ; {.3} <>
```

You can change the fill opacity by specifying the the last curly brace option `{<fill opacity>}` immediately *after the semicolon*.

```
% \tzpolygon: shift
\begin{tikzpicture}
\tzhelplines(4,3)
\tzpolygon*[draw=blue,auto]
    (0,1){Side A}[sloped,red]
    (1,3){B}
    (2,3)
    (3,2){Side D}[swap,sloped]
    (1,0);
\tzpolygon*[green,auto,dashed,text=black]<1,-.5>
    (0,1)(1,3)(2,3){C}(3,2)(1,0); {.7}
\end{tikzpicture}
```

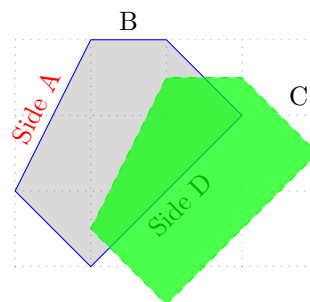

You can also change the defaults using `\setztzfillcolor` and `\setztzfillopacity`.

16.1.3 \tzpolygon+, \tzpolygon*+: Relative coordinates: Semicolon versions

The plus version `\tzpolygon+` uses each coordinate (except the first one) relative (with `++`) to the previous coordinate.

Everything else is the same as in \tzpolygon.

`\tzpolygon*+` is just a plus version of `\tzpolygon*`.

```
\tzpolygon+(1,1)(2,2)(3,1)(4,3); % works like:
\draw (1,1) -- ++(2,2) -- ++(3,1) -- ++(4,3) -- cycle;
```

```
\tzpolygon+[dashed]"AA"(1,1)(2,2){A}(3,1){B}[below]; % works like:
\draw [dashed,name path=AA] (1,1)
    -- ++(2,2)
    -- ++(3,1) node {A}
    -- ++(4,3) node [below] {B}
    -- cycle;
```

```

% \tzpolygon: shift
\begin{tikzpicture}
\tzhelplines(4,3)
\tzpolygon*[blue,auto]
(0,1){Side A}[sloped,red]
(1,2){B}
(1,0)
(1,-1){Side D}[swap,sloped]
(-2,-2);
\tzpolygon*[green,auto,dashed,text=black]<1,-.5>
(0,1)(1,2)(1,0){C}(1,-1)(-2,-2); {.7}
\end{tikzpicture}

```

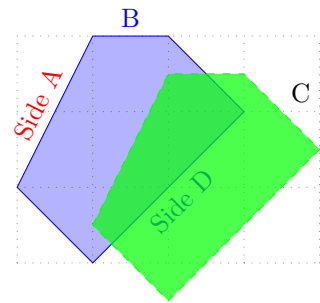

16.2 Rectangles

16.2.1 \tzframe and its variants

\tzframe accepts two coordinates draws a rectangle.

```

% syntax: minimum
\tzframe(<coor>)(<coor>)
% syntax: full
\tzframe[<opt>]<shift coor>"<path name>"(<coor1>)(<coor2>)<code.append>
% defaults
[]<>"(<m>)(<m>)<>

```

\tzrectangle and \tzbox are aliases of \tzframe.

```

\tzframe(0,1)(3,2) % works like:
\draw (0,1) rectangle (3,2);

```

The plus version \tzframe+ uses the second coordinate as the coordinate relative (with ++) to the first. \tzrectangle+ and \tzbox+ are aliases of \tzframe+.

```

\tzframe+(0,1)(3,2) % works like:
\draw (0,1) rectangle ++(3,2);

```

```

% \tzframe, \tzframe+
\begin{tikzpicture}
\tzhelplines(4,3)
\tzframe(0,0)(3,2)
\tzframe+[blue,rounded corners=2mm](1,3)(1,-2)
\end{tikzpicture}

```

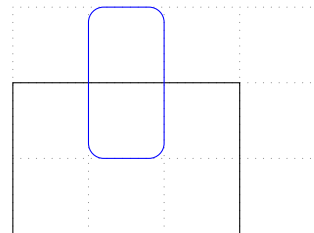

The starred version \tzframe* fills the interior with black!50 with fill opacity=.3 and text opacity=1, by default. (\tzrectangle* and \tzbox* are aliases of \tzframe*.)

\tzframe+ has also its starred version \tzframe*+. (\tzrectangle*+ and \tzbox*+ are aliases of \tzframe*+.)

```

% syntax
\tzframe*[<opt>]<shift coor>"<path name>"
(<coor1>)(<coor2>){<fill opacity>}<code.append>

```

```
% defaults
```

```
*[fill=black!50,fill opacity=.3,text opacity=1]<>"(<m>)(<m>){.3}<>
```

With the starred versions, you can change the fill opacity using the last option `{<fill opacity>}`.

```
% \tzframe*(+)
```

```
\begin{tikzpicture}  
\tzhelplines(4,3)  
\tzframe[fill](0,0)(3,2)  
\tzframe*+[green,rounded corners=2mm](1,3)(1,-2){.7} %%  
\end{tikzpicture}
```

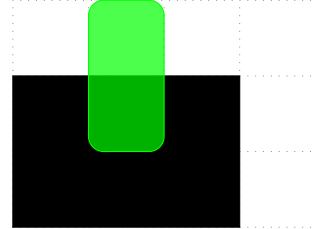

You can move `\tzframe` and its variants by specifying the option `<shift coor>` immediately before the first mandatory coordinate. The empty shift option `<>` is not allowed.

```
% \tzframe*(+): shift
```

```
\begin{tikzpicture}  
\tzhelplines*(4,4)  
\tzframe(0,0)(3,2)  
\tzframe[blue,dashed]<1,1>(0,0)(3,2)  
\tzcoors(1,3)(A)(1,-2)(B);  
\tzframe*+[blue,rounded corners=2mm](A)(B)  
\tzframe*+[red,rounded corners=2mm]<-.5,-.5>(A)(B)  
\tzframe*+[green,rounded corners=2mm]<1,1>(A)(B)  
\end{tikzpicture}
```

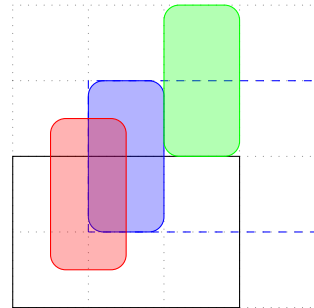

You can use the last option `<code.append>` to add more TikZ code.

```
% \tzframe(*), \tzrectangle(*): <code.append>
```

```
\begin{tikzpicture}  
\tzhelplines(4,4)  
\tzframe*[blue,even odd rule](0,0)(3,2)  
<(.5,.5) rectangle (2.5,1.5)>  
\tzframe[fill=green,even odd rule](2,1)(4,4)  
<(2.3,1.2) rectangle (3.5,3.6)>  
\end{tikzpicture}
```

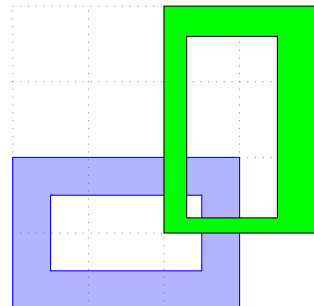

16.2.2 `\tzrectanglering*`

`\tzrectanglering*` draws two rectangles and draws a rectangle ring by filling the interior with the default options `even odd rule`, `fill=black!50`, `fill opacity=.3`, and `text opacity=1`.

```
% syntax: minimal
```

```
\tzrectanglering*(<coorA1>)(<coorA2>)(<coorB1>)(<coorB2>)
```

```
% syntax: full
```

```
\tzrectanglering* [<opt>] <shift coor>  
(<coorA1>)(<coorA2>)(<coorB1>)(<coorB2>)  
{<fill opacity>}<code.append>
```

```
% defaults:
```

```
*[even odd rule,fill=black!50,fill opacity=.3,text opacity=1]  
<>(<m>)(<m>)( )(.3)<>
```

```

\tzrectanglering*(A1)(A2)(B1)(B2) % works like:
\draw [fill=black!50,fill opacity=.3,text opacity=1, even odd rule]
(A1) rectangle (A2)
(B1) rectangle (B2) ;

```

```

% \tzrectanglering*
\begin{tikzpicture}
\tzhelplines(4,2)
\tzrectanglering*[blue](0,0)(3,2)(.5,.5)(2.5,1.5)
\end{tikzpicture}

```

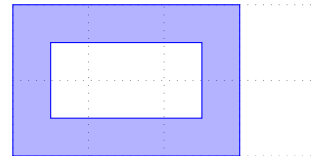

```

% \tzrectanglering*: shift
\begin{tikzpicture}
\tzhelplines(4,3)
\tzrectanglering*[blue](0,0)(3,2)(.5,.5)(2.5,1.5)
\tzrectanglering*[red]<.9,.9>(0,0)(3,2)(.5,.5)(2.5,1.5)
\end{tikzpicture}

```

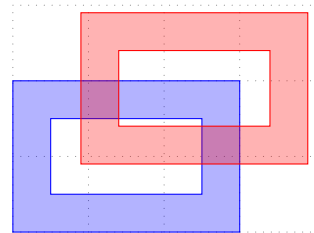

\tzrectanglering draws two rectangles with the default option even odd rule.

```

% syntax: minimal
\tzrectanglering(<coorA1>)(<coorA2>)(<coorB1>)(<coorB2>)
% syntax: full
\tzrectanglering[<opt>]<shift coor>(<coorA1>)(<coorA2>)
(<coorB1>)(<coorB2>)<code.append>
% defaults
[even odd rule]<>(<m>)(<m>)( ) ( ) <>

```

```

\tzrectanglering(0,0)(2,2)(.5,.5)(1.5,1.5) % works like:
\draw (0,0) rectangle (2,2)
(.5,.5) rectangle (1.5 and 1.5);

```

```

% \tzrectanglering: shift
\begin{tikzpicture}
\tzhelplines(4,3)
\tzrectanglering[blue](0,0)(3,2)(.5,.5)(2.5,1.5)
\tzrectanglering[red,fill=green]<.9,.9>
(0,0)(3,2)(.5,.5)(2.5,1.5)
\end{tikzpicture}

```

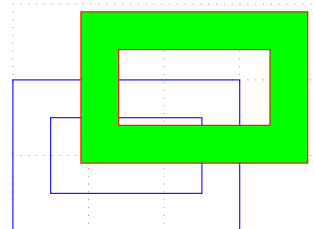

```

% \tzrectanglering*
\begin{tikzpicture}
\tzhelplines(4,3)
\tzrectanglering*[blue](0,0)(3,2)(1.5,1.5)(4,3)
\end{tikzpicture}

```

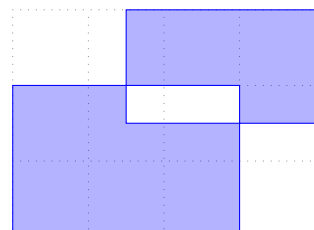

```

% \tzrectanglering(*): nonzero rule, fill opacity
\begin{tikzpicture}
\tzhelplines(4,3)
\tzrectanglering*[red,draw=none,nonzero rule]
(0,0)(3,2)(1.5,1.5)(4,3){1}
\tzrectanglering[fill=white](0,0)(3,2)(1.5,1.5)(4,3)
\end{tikzpicture}

```

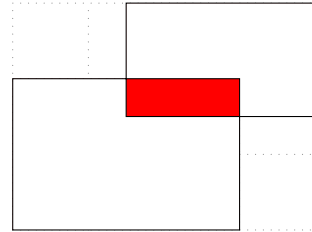

With the last option `<code.append>` you can add some more TikZ code.

```

% \tzframering(*), \tzboxring(*)
\begin{tikzpicture}
\tzhelplines(4,4)
\tzframering*[blue](0,0)(3,4)
< (1.3,1.3) circle (1cm) (2,3) circle (.5) >
\tzboxring[pattern=bricks](1,1)(4,3)
< (2.5,2) ellipse (1 and .7) >
\end{tikzpicture}

```

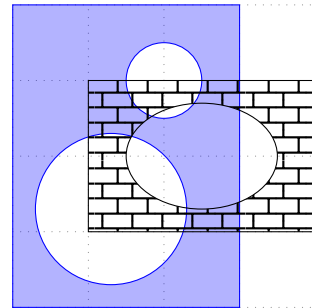

`\tzframering` and `\tzboxring` are aliases of `\tzrectanglering`.
`\tzframering*` and `\tzboxring*` are aliases of `\tzrectanglering*`.

16.3 Circles and rings

16.3.1 `\tzcircle(*)`

`\tzcircle` draws a circle around a specified coordinate with a specified radius. The coordinate and the radius are mandatory.

```

% syntax
\tzcircle[<opt>]<shift coor>"<path name>"(<coor>)(<radius>)<code.append>
% defaults
[]<>"(<m>)(<m>)<>

```

```

\tzcircle(0,0)(1cm) % works like:
\draw (0,0) circle (1cm);

```

```

% \tzcircle: "name path" and intersections
\begin{tikzpicture}
\tzhelplines(4,3)
\tzcircle(1,1)(1cm)
\tzcircle[blue,dashed]"AA"(2,2)(1cm)
\tzvXpointat{AA}{2.5}{A} % intersections
\tzdots*(A-1){$A_1$}[r](A-2){$A_2$}[r];
\end{tikzpicture}

```

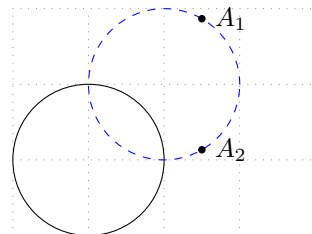

The starred version `\tzcircle*` fills the interior with `fill=black!50` with `fill opacity=.3` and `text opacity=1`, by default. You can change the fill opacity using the curly brace option `{<fill opacity>}` right after the option `(<radius>)`.

```

% syntax
\tzcircle* [<opt>] <shift coor> "<path name>"
            (<coor>) (<radius>) {<fill opacity>} <code.append>
% defaults
*[fill=black!50,fill opacity=.3,text opacity=1] <> "" (<m>) (<m>) {.3} <>

```

You can move the circles by specifying the option `<shift coor>` before the center coordinate or immediately before the option `"<path name>"` if it exists. The empty shift option `<>` is not allowed.

```

% \tzcircle(*): shift
\begin{tikzpicture}
\tzhelplines(4,4)
\tzcoors(2,2)(A)(3,1)(B);
\tzcircle(2,2)(1)
\tzcircle[blue,dashed]<-.5,0>(A)(1)
\tzcircle*(3,1)(.5cm)
\tzcircle*[blue]<.5,0>(B)(.5cm)
\end{tikzpicture}

```

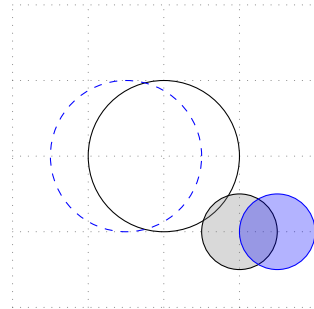

With the last option `<code.append>`, you can add some TikZ code.

```

% \tzcircle(*): <code.append>
\begin{tikzpicture}
\tzhelplines(4,4)
\tzcoors(2,2)(A)(3,1)(B);
\tzcircle*[blue,even odd rule](A)(1cm)
            <(2,2) circle (1.5)>
\tzcircle[fill=green,even odd rule](B)(1cm)
            <(3,1) circle (.7)>
\end{tikzpicture}

```

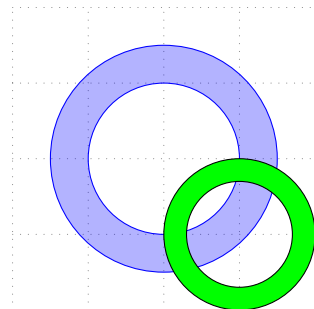

16.3.2 \tzring*

`\tzring*` draws two circles and draws a circle ring by filling the interior with the default options `even odd rule`, `fill=black!50`, `fill opacity=.3`, and `text opacity=1`.

```

% syntax: minimal
\tzring* (<coor>) (<radius>) (<coor>) (<radius>)
% syntax: full
\tzring* [<opt>] <shift coor>
            (<coor>) (<radius>) (<coor>) (<radius>) {<fill opacity>} <code.append>
% defaults:
*[even odd rule,fill=black!50,fill opacity=.3,text opacity=1]
<> (<m>) (<m>) () () {.3} <>

```

```

\tzring*(0,0)(1cm)(0,0)(1.5cm) % works like:
\draw [fill=black!50,fill opacity=.3,text opacity=1, even odd rule]
      (0,0) circle (1cm) (0,0) circle (1.5cm);

```



```

% \tzring*: fill opacity
\begin{tikzpicture}
\tzhelplines(4,4)
\tzring*[green] (2,2) (1) (2,2) (1.5)
\tzring*[fill=blue] (3,1) (1) (3,1) (.7) {1} %
\end{tikzpicture}

```

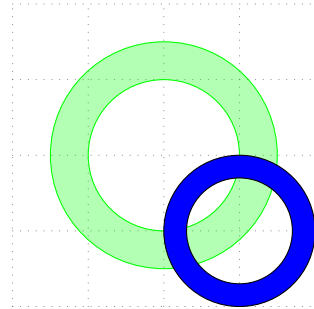

```

% \tzring*: nonzero rule
\begin{tikzpicture}
\tzhelplines(4,2)
\tzring*[fill=red,nonzero rule] (1,1) (1) (2,1) (1)
\end{tikzpicture}

```

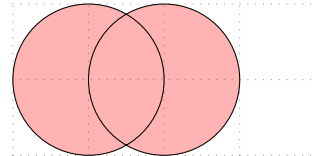

```

% \tzring*: nonzero rule
\begin{tikzpicture}
\tzhelplines(4,2)
\tzring*[fill=red,nonzero rule] (1,1) (1) (2,1) (1) {1}
\tzring*[fill=white] (1,1) (1) (2,1) (1) {1}
\end{tikzpicture}

```

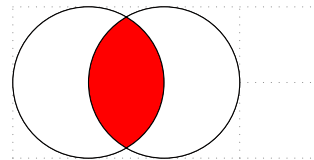

```

% \tzring*: nonzero rule
\begin{tikzpicture}
\tzhelplines(4,3)
\tzframe(0,0) (4,3)
\tzring*[blue] (1.5,1.5) (1) (2.5,1.5) (1)
\end{tikzpicture}

```

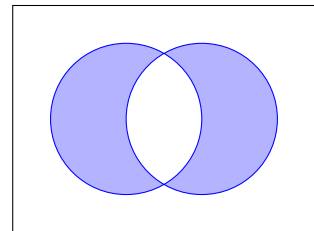

`\tzring` draws two circles with the default option `even odd rule`.

```

% syntax: minimal
\tzring*(<coor>) (<radius>) (<coor>) (<radius>)
% syntax: full
\tzring* [<opt>] <shift coor>
          (<coor>) (<radius>) (<coor>) (<radius>) <code.append>
% defaults:
[even odd rule] <> (<m>) (<m>) () () <>

```

```

% \tzring: shift
\begin{tikzpicture}
\tzhelplines(4,4)
\tzcoors(2,2) (A) (3,1) (B);
\tzring[blue] (2,2) (1) (2,2) (1.5)
\tzring[fill=green] <-1,0> (3,1) (1) (3,1) (.7) % shift
\end{tikzpicture}

```

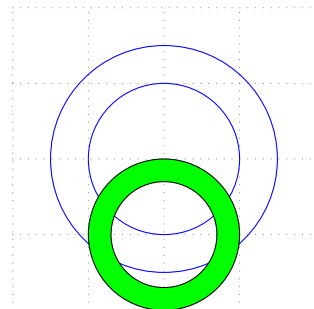

You can add some TikZ code with the last option `<code.append>`.

```

% \tzring(*): <code.append>
\begin{tikzpicture}
\tzhelplines(4,3)
\tzring*[blue](2,2)(1)< (1.5,2) circle (.3 and .5) >
\tzring*[pattern=bricks](3,1)(1)
  < (2.5,.5) rectangle ++(1,1) >
\end{tikzpicture}

```

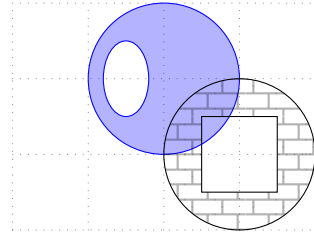

```

% \tzring(*): nonzero rule, fill opacity
\begin{tikzpicture}
\tzhelplines(4,3)
\tzring*[fill=red,draw=none,nonzero rule](1,1)(1){1}
  <(3,.5) rectangle (1.5,3)>
\tzring*[fill=white](1,1)(1)
  <(3,.5) rectangle (1.5,3)>
\end{tikzpicture}

```

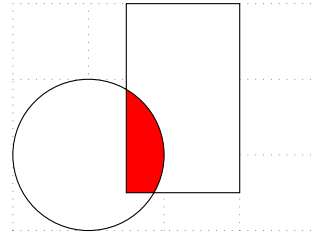

`\tzring` and `\tzring*` are aliases of `\tzring` and `\tzring*`, respectively.

16.4 Ellipses

16.4.1 `\tzellipse*`

`\tzellipse` draws an ellipse around a specified coordinate with the specified x-radius and y-radius.

The starred version `\tzellipse*` fills the interior with `fill=black!50` with `fill opacity=.3` and `text opacity=1`, by default.

`\tzellipse*` is basically the same as `\tzcircle*`.

```

% syntax
\tzellipse* [<opt>] <shift coor> "<path name>"
  (<coor>) (<x and y radius>) {<fill opacity>} <code.append>
% defaults: \tzellipse*
* [fill=black!50,fill opacity=.3,text opacity=1] <> "" (<m>) (<m>) {.3} <>
% defaults: \tzellipse
* [] <> "" (<m>) (<m>) <>

```

```

\tzellipse(0,0)(1 and .5) % works like:
\draw (0,0) ellipse (1 and .5);

```

```

% \tzellipse: "name path" and intersections
\begin{tikzpicture}
\tzhelplines(4,3)
\tzellipse(1,1)(1cm and 7mm)
\tzellipse[blue,dashed]"AA"(2,2)(1cm and 7mm)
\tzvXpointat{AA}{2.5}(A) % intersections
\tzdots*(A-1){$A_1$}[r](A-2){$A_2$}[r];
\end{tikzpicture}

```

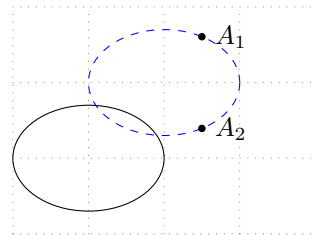

You can move the ellipse by specifying the option `<shift coor>` immediately before the mandatory coordinate. The *empty* shift option `<>` is *not allowed*.

Using the last option `{<fill opacity>}`, you can change the fill opacity.

```

% \tzellipse(*)
\begin{tikzpicture}
\tzhelplines(4,3)
\tzellipse(2,2)(1.5 and 1)
\tzellipse*[blue](2,1)(1 and 1.5){.5} % fill opacity
\tzellipse[fill=green](3,1)(1cm and .5cm)
\tzellipse*[red]<0,-.5>(3,1)(1cm and .5cm) % shift
\end{tikzpicture}

```

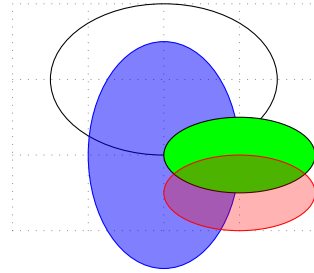

You can add some TikZ code with the option `<code.append>`.

```

% \tzellipse(*), \tzoval(*): <code.append>
\begin{tikzpicture}
\tzhelplines(4,4)
\tzoval*[blue,even odd rule](2,2)(1.5 and 1)
<(2,2) ellipse (2 and 1.5)>
\tzellipse[fill=green,even odd rule](3,1)(1 and 1)
<(3,1) ellipse (.5 and .8)>
\end{tikzpicture}

```

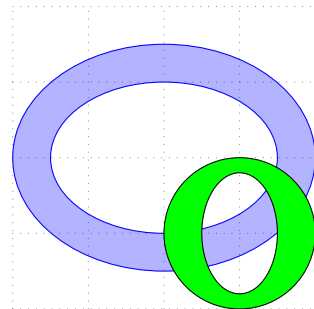

`\tzoval` is an alias of `\tzellipse` and `\tzoval*` is an alias of `\tzellipse*`.

16.4.2 `\tzellipsering(*)`

`\tzellipsering*` draws two ellipses and draws an ellipse ring by filling the interior with the default options `even odd rule`, `fill=black!50`, `fill opacity=.3`, and `text opacity=1`.

`\tzellipsering*` draws two ellipses with the default option `even odd rule`.

`\tzellipsering(*)` is basically the same as `\tzring(*)`.

```

% syntax: minimal
\tzellipsering*(<coor>)(<x and y radius>)(<coor>)(<x and y radius>)
% syntax: full
\tzellipsering* [<opt>] <shift coor>
<(coor)> (<x and y radius>) (<coor>) (<x and y radius>)
{<fill opacity>} <code.append>
% defaults: \tzellipsering*
*[even odd rule,fill=black!50,fill opacity=.3,text opacity=1]
<> (<m>) (<m>) () (.3) <>
% defaults: \tzellipsering
*[even odd rule] <> (<m>) (<m>) () () <>

```

```

\tzellipsering*(2,1)(1cm and 1.5cm)(2,2)(1.5cm and 1.5cm) % works like:
\draw [fill=black!50,fill opacity=.3,text opacity=1, even odd rule]
(2,1) ellipse (1cm and 1.5cm) (2,2) ellipse (1.5cm and 1.5cm);

```

```

% \tzring*: fill opacity
\begin{tikzpicture}
\tzhelplines(4,4)
\tzellipsering*[blue](2,2)(1 and 1)(2,2)(1.5cm)
\tzring*[fill=green](2,1)(1 and 1.5)(2,1)(.7 and 1){1}
\end{tikzpicture}

```

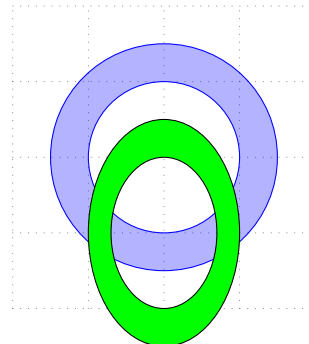

```

% \tzellipsering(*)
\begin{tikzpicture}
\tzhelplines(4,4)
\tzcoors(2,2)(A)(3,1)(B);
\tzellipsering*[blue](2,2)(1 and 1.5)
<(1.5,2.5) circle (3mm) >
\tzellipsering[pattern=bricks]<1,0>(2,1)(1 and 1.5)
<(2.5,.5) rectangle ++(1,1) >
\end{tikzpicture}

```

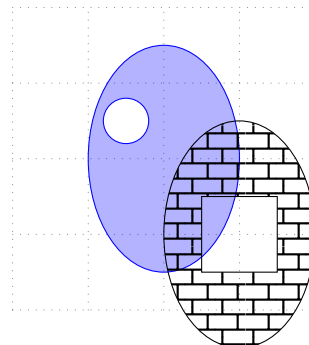

```

% \tzellipsering(*)
\begin{tikzpicture}
\tzhelplines(4,4)
\tzcoors(2,2)(A)(3,1)(B);
\tzovalring*[fill=red,draw=none,nonzero rule]
(2,2)(1 and 1.5)(3,1)(1 and 1.5){1}
\tzovalring[fill=white]
(2,2)(1 and 1.5)(3,1)(1 and 1.5)
\end{tikzpicture}

```

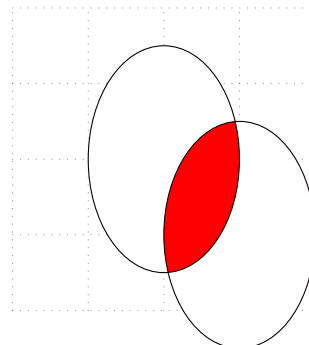

`\tzovalring` is an alias of `\tzellipsering` and `\tzovalring*` is an alias `\tzellipsering*`.

17 Arcs, Wedges, and Angle Marks

17.1 `\tzarc(')`: Centered arcs

17.1.1 Arcs

`\tzarc` draws an arc around a specified *center coordinate*.

```

% syntax: minimum
\tzarc(<coor>)(<angA:angB:radius>)
% syntax: full
\tzarc[<opt>]<shift coor>"<path name>"
(<coor>)(<angA:angB:radius>){<text>}[<node opt>]<code.append>
% defaults
[]<>"(<m>)(<m>){}[]<>

```

```

\tzarc(1,1)(30:120:1) % works like:
\draw (1,1) ++(30:1) arc (30:120:1);

```

The *swap version* `\tzarc'` switches its drawing direction from `counterclockwise` to `clockwise` and vice versa.

```
\tzarc'(1,1)(30:120:1) % works like:
\draw (1,1) ++(30:1) arc (30:120-360:1);
```

```
% \tzarc, \tzarc'
\begin{tikzpicture}
\tzhelplines(4,3)
\tzdots*(1,1)(3,2);
\tzarc [blue,->] (1,1)(-45:180:1)
\tzarc' [dashed,->] (1,1)(-45:180:1)
\draw [->] (3,2) ++(-45:1) arc (-45:180:1);
\draw [dashed,->] (3,2) ++(-45:1) arc (-45:180-360:1);
\end{tikzpicture}
```

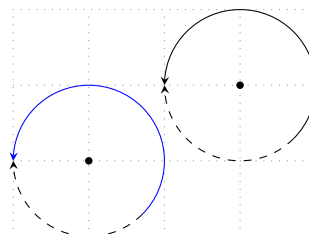

You can add text along the arc by specifying the options `{<text>}` and `[<node opt>]` immediately after the two mandatory arguments.

```
% \tzarc(): adding text
\begin{tikzpicture}
\tzhelplines(4,3)
\tzarc [blue,->] (1,1)(-45:180:1){A}[r]
\tzarc' [dashed,->] (1,1)(-45:180:1)
\tzarc [->] (3,2)(-45:180:1){arc}[midway,sloped]
\tzarc' [dashed,->] (3,2)(-45:180:1)
\end{tikzpicture}
```

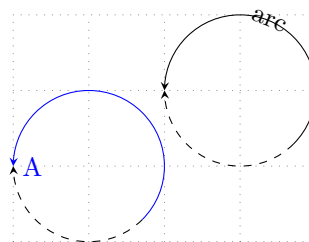

You can move arcs by specifying the option `<shift coor>` before the center coordinate or immediately before the option `"<path name>"` if it exists. The *empty shift option* `<>` is *not allowed*.

```
% \tzarc(): shift, name path, intersection
\begin{tikzpicture}
\tzhelplines(4,3)
\tzarc [blue,->] (1,1)(-45:180:1){A}[r]
\tzarc' [dashed,->] (1,1)(-45:180:1)
\tzarc [blue,->] <2,1>(1,1)(-45:180:1){A-shifted}[r]
\tzarc' [dashed,->]<2,1>"AA"(1,1)(-45:180:1) %%
\tzvXpointat*{AA}{2.5}
\end{tikzpicture}
```

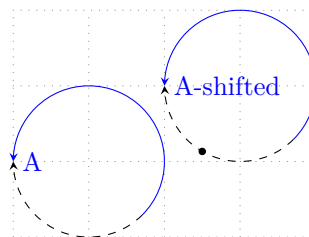

You can also extend the path of `\tzarc` by specifying the last option `<code.append>` with TikZ code written in it. For example, `<--cycle>` makes the path closed.

```
% \tzarc(): <code.append>
\begin{tikzpicture}
\tzhelplines(4,3)
\tzarc [blue,->] (1,1)(-45:180:1)
< to[bend left] ++(1,-1) >
\tzarc [red,->] <2,1>(1,1)(-45:180:1)<--cycle>
\end{tikzpicture}
```

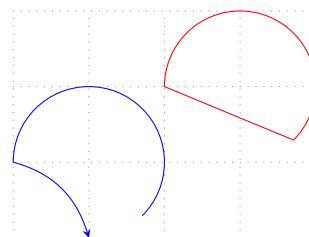

17.1.2 Elliptical arcs

`\tzarc` draws an *elliptical arc* if you specify x-radius and y-radius.

```
% \tzarc: elliptical
\begin{tikzpicture}
\tzhelplines(4,4)
\tzarc[->,red](1,1)(30:270:1.5 and 0.5)
\tzarc'[->,dotted](1,1)(30:270:1.5 and 0.5)
\tzdots*(1,1)(2,2);
\tzarc[->,blue,dashed](2,2)(0:-270:1 and 2)
\tzarc'[->](2,2)(0:-270:1 and 2)
\end{tikzpicture}
```

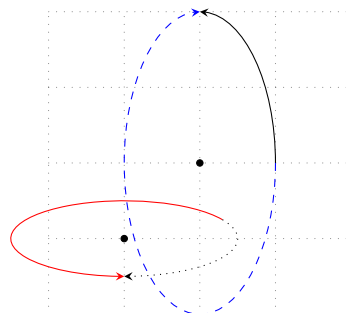

```
% \tzarc: elliptical
\begin{tikzpicture}
\tzhelplines(4,4)
\tzarc[->,red](1,1)(30:270:1.5 and 0.5)
\tzdots*(1,1)(2,2);
\tzarc[blue,fill=green,fill opacity=.3]
(2,2)(0:-270:1 and 2)<--(2,2)--cycle> % code.append
\tzarc[->,blue,dashed]
<1,0>(2,2)(0:-270:1 and 2) % shift
\end{tikzpicture}
```

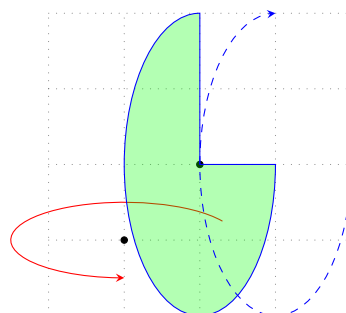

17.2 `\tzarcfrom`('): Arcs as in TikZ

`\tzarcfrom` draws an arc starting from a specified point, like TikZ does.

```
% syntax: minimum
\tzarcfrom(<coor>)(<angA:angB:radius>)
% syntax: full
\tzarcfrom[<opt>]<shift coor>"<path name>"
(<coor>)(<angA:angB:radius>){<text>}[<node opt>]<code.append>
% defaults
[]<>"(<m>)(<m>){}[]<>
```

```
\tzarcfrom(1,1)(30:120:1) % works like:
\draw (1,1) arc (30:120:1);
```

Everything else is the same as in `\tzarc`.

`\tzarcfrom'` is the *swap version* of `\tzarcfrom`.

```
% \tzarcfrom
\begin{tikzpicture}
\tzhelplines(4,3)
\tzdots*(1,1)(3,2);
\tzarcfrom [blue,->] (1,1)(-45:180:1){A}[r]
\tzarcfrom' [dashed,->] (1,1)(-45:180:1)
\tzarcfrom[->] (3,2)(-45:180:1){arc}[midway,sloped]
\tzarcfrom' [dashed,->] (3,2)(-45:180:1)
\end{tikzpicture}
```

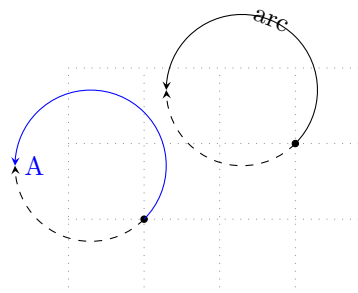

17.3 \tzarcsfrom: Connected arcs: Semicolon version

The macro \tzarcsfrom (i.e. \tzarcs + from) accepts an arbitrary number of parenthesis arguments in the form of (<angA:angB:radius>) following the start coordinate. Since tzarcsfrom is a semicolon version, you need to enter a *semicolon* to indicate when the repetition ends.

```
% syntax: minimum
\tzarcsfrom(<start coor>
            (<angA:angB:radius>)..repeated..(<angA:angB:radius>) ;
% syntax: full
\tzarcsfrom[<opt>]<shift coor>"<path name>"
            (<start coor>)(<angA:angB:radius>){<text>}[<node opt>]
            ..repeated..(){}[] ; <code.append>
% defaults
[]<>"(<m>) (<m>){}[]..repeated..(){}[] ; <>
```

```
% \tzarcfrom: adding text, <code.append>
\begin{tikzpicture}
\tzhelplines(4,4)
\tzcoor*(3,2)(A)
\tzarcsfrom[->,auto](A)
  (0:180:1){1}[midway]
  (180:360:1.2){2}[midway]
  (0:180:1.4){3}[midway,swap]
  (180:360:1.6){4}[midway,swap];
  < node [right,blue] {End!} >
\end{tikzpicture}
```

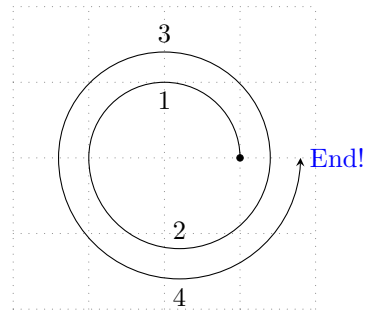

```
% \tzarcfrom: shift
% flag: step 1
\begin{tikzpicture}
\tzhelplines(-2,-2)(2,2)
\tzdot*(0,0)
\edef\x{atan(2/3)}
\tzarcsfrom[red,->](0,0)
  (-\x:-\x-180:1){red 1}[midway];
\tzarcsfrom[blue,->](0,0)
  (180-\x:-\x:1){blue 1}[midway];
\tzarcsfrom[dashed,-><.5,.5>](0,0)
  (180-\x:-\x:1){blue 1}[midway];
\end{tikzpicture}
```

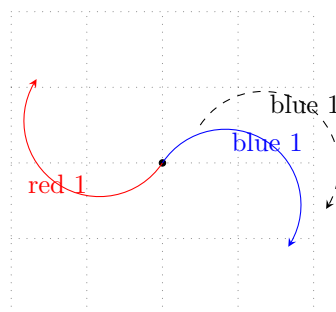

```
% flag: step 2
\begin{tikzpicture}
\edef\x{atan(2/3)}
\tzarcsfrom[red](0,0)
  (-\x:-\x-180:1){1}[midway]
  (-\x+180:-\x:2){2}[midway];
\tzarcsfrom[blue](0,0)
  (180-\x:-\x:1){1}[midway]
  (-\x:-\x-180:2){2}[midway];
\end{tikzpicture}
```

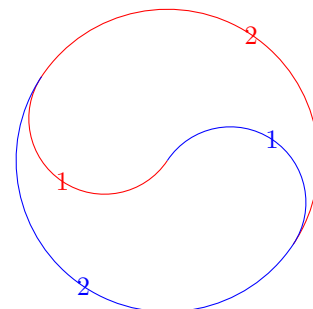

```

% flag: step 3
\definecolor{flagred}{RGB}{205,48,57}
\definecolor{flagblue}{RGB}{17,73,156}
\begin{tikzpicture}[scale=1]
\edef\x{atan(2/3)}
\tzarcfrom[draw=none,fill=flagred](0,0)
(-\x:-\x-180:1)
(-\x+180:-\x:2)
(-\x:-\x+180:1);<-- cycle>
\tzarcfrom[draw=none,fill=flagblue](0,0)
(180-\x:-\x:1)
(-\x:-\x-180:2)
(-\x+180:-\x+360:1);<-- cycle>
\end{tikzpicture}

```

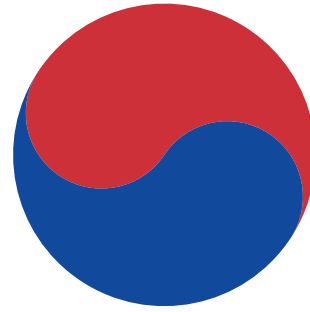

```

% flag: shift
\definecolor{flagred}{RGB}{205,48,57}
\definecolor{flagblue}{RGB}{17,73,156}
\begin{tikzpicture}[scale=1]
\edef\x{atan(2/3)}
\tzarcfrom[draw=none,fill=flagred]<.1,.3>
↪ (0,0)
(-\x:-\x-180:1)
(-\x+180:-\x:2)
(-\x:-\x+180:1);<-- cycle>
\tzarcfrom[draw=none,fill=flagblue](0,0)
(180-\x:-\x:1)
(-\x:-\x-180:2)
(-\x+180:-\x+360:1);<-- cycle>
\end{tikzpicture}

```



17.4 Wedges

17.4.1 \tzwedge(')

\tzwedge draws a wedge around a specified *center* coordinate.

\tzwedge works similarly to \tzarc, but it forms a closed path from the center coordinate. \tzwedge does not have the option <code>.append</code>.

```

% syntax
\tzwedge[<opt>]<shift coor>"<path name>"
(<coor>)(<angA:angB:radius>){<text>}[<node opt>]
% defaults
[]<>"(<m>)(<m>){}[midway]

```

```

\tzwedge(1,1)(30:120:1) % works like:
\draw (1,1) -- ++(30:1) arc (30:120:1) -- cycle;

```

The swap version \tzwedge' is the *swap version* of \tzwedge. It switches the drawing direction from counterclockwise to clockwise and vice versa.

```
\tzwedge'(1,1)(30:120:1) % works like:
\draw (1,1) -- ++(30:1) arc (30:120:360:1) -- cycle;
```

```
% \tzwedge, \tzwedge'
\begin{tikzpicture}
\tzcoor*(2,1)(A)(3pt)
\tzhelplines(4,3)
\tzwedge[blue,very thick](A)(30:120:1.5)
\tzarc[->,green](A)(30:120:1.3)
\tzwedge'[dashed](A)(0:135:1.5){clockwise}[sloped,red]
\tzarc'[->,green](A)(0:135:1.3)
\tzwedge'[fill](A)(-60:240:1)
\end{tikzpicture}
```

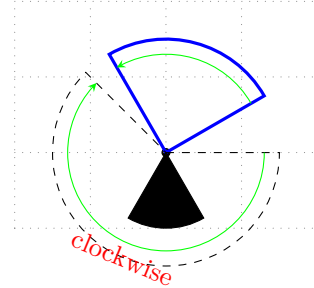

```
% \tzwedge('): shift
\begin{tikzpicture}
\tzcoor*(2,1)(A)
\tzhelplines(4,3)
\tzwedge[blue,very thick]<.1,.1>(A)(30:120:1.5) % shift
\tzarc[->,lightgray]<.1,.1>(A)(30:120:1.3) % shift
\tzwedge'[dashed](A)(0:135:1.5){clockwise}[sloped,red]
\tzarc'[->,lightgray](A)(0:135:1.3)
\tzwedge'[fill]<2,0>(A)(-60:240:1) % shift
\end{tikzpicture}
```

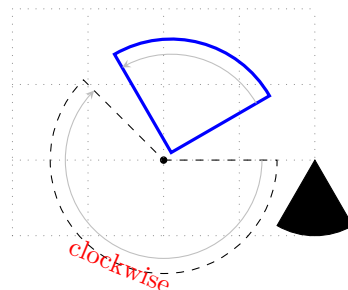

17.4.2 \tzwedge*(')

The starred version `\tzwedge*` fills the wedges with `fill=black!50` with `fill opacity=.3` and `text opacity=1`, by default. With `\setztzfillcolor` and `\setztzfillopacity`, you can change the default values. You can also change the fill opacity by specifying the last optional argument `{<fill opacity>}`.

```
% syntax:
\tzwedge* [<opt>] <shift coor> "<path name>"
  (<coor>) (<angA:angB:radius>) {<text>} [<node opt>] {<fill opacity>}
% defaults:
*[fill=black!50,fill opacity=.3,text opacity=1] <> "(<m>)<(>)<(>)" {<midway>} {<.3>}
```

`\tzwedge*` is the *swap version* of `\tzwedge*`.

```
% \tzwedge*, \tzwedge*'
\begin{tikzpicture}[->,>=stealth]
\tzhelplines(3,3)
\tzwedge[very thick,blue](1,1)(30:120:1.5)
\tzwedge*[-,very thick,blue,fill=red](1,1)(30:120:1)
\tzwedge'[dashed](1,1)(30:120:1.5){clockwise}[pos=.45]
\tzwedge*'[dashed,fill=green](1,1)(-90:180:1)
\tzdot*(1,1)
\end{tikzpicture}
```

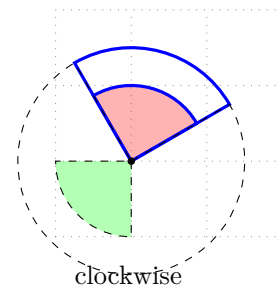

```

% \tzwedge*(): shift, fill opacity
\begin{tikzpicture}
\tzdot*(1,1)
\tzhelplines(3,3)
\tzwedge[blue,very thick](1,1)(30:120:1.5)
\tzwedge[red,very thick]<.5,.5>(1,1)(30:120:1.5)
\tzwedge'[dashed](1,1)(0:135:1.5)
\tzwedge*[fill=blue](1,1)(300:240:1){B}[b]
\tzwedge*[blue]<2,0>(1,1)(300:240:1){B}[b]{.7}
\end{tikzpicture}

```

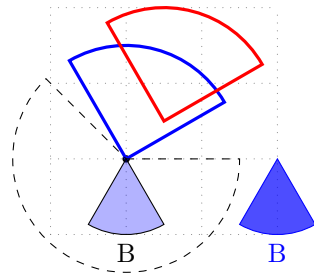

```

% \tzwedge*(): name path, intersections
\begin{tikzpicture}
\tzhelplines(3,3)
\tzwedge'[blue]"AA"(0,1)(45:330:2)
\tzvXpointat{AA}{1}(A)
\tzdots*(A){A}[al](A-2);
\tzwedge*[blue,fill=red]
(0,1)(45:330:2mm){$\theta$}[midway,r]
\end{tikzpicture}

```

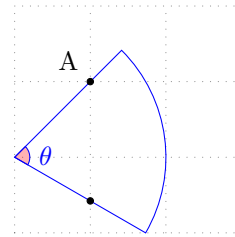

17.5 Angle marks

17.5.1 \tzpointangle: Angles between points

`\tzpointangle(<coor1>(<coor2>(<\mymacro>)` computes the angle between two points and allows you to use, where `(coor1)` serves as the coordinate of the center.

```

\begin{tikzpicture}[font=\scriptsize]
\tzhelplines(5,4)
\tzcoors*(4,2)(A){A}(1,1)(B){B}[135];
\tzline[red,dashed](0,1)(5,1)
\tzline[tzextend={1cm}{1cm}](B)(A) % (B): center
\tzpointangle(B)(A){\myAngA}
\tznode(3,1){\myAngA\textdegree}[ar=2mm,absolute]
\tzarc(1,1)(0:\myAngA:2cm)
\end{tikzpicture}

```

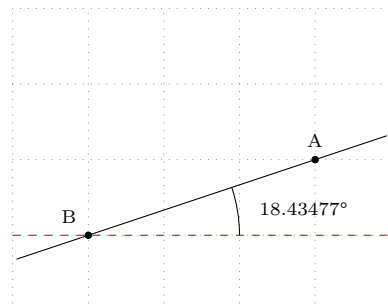

```

\begin{tikzpicture}[font=\scriptsize]
\tzhelplines(5,4)
\tzcoors*(4,2)(A){A}(1,1)(B){B}[135](2,3)(C){C};
\tzline[red,dashed](0,1)(5,1)
\tzline[tzextend={1cm}{1cm}](B)(A)
\tzline[tzextend={1cm}{1cm}](B)(C)
\tzpointangle(B)(A){\myAngA}
\tznode(3,1){\myAngA\textdegree}[ar=2mm,absolute]
\tzarc(1,1)(0:\myAngA:2cm)
\tzpointangle(B)(C){\myAngC}
\tznode(2,2){\myAngC\textdegree}[r=3mm]
\tzarc(1,1)(0:\myAngC:1.5cm)
\tzarc(1,1)(\myAngA:\myAngC:10pt){$\theta$}[ar,midway]
\tzarc(1,1)(\myAngA:\myAngC:11pt)
\end{tikzpicture}

```

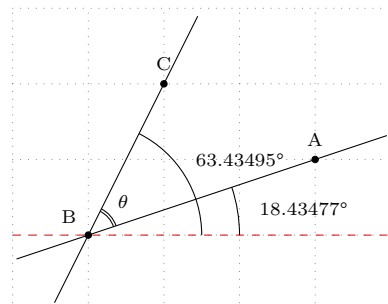

```

\begin{tikzpicture}[font=\scriptsize]
\tzhelplines(5,4)
\tzcoors*(4,2)(A){A}(1,1)(B){B}[135](2,3)(C){C} ;
\tzline[tzextend={1cm}{1cm}](B)(A)
\tzline[tzextend={1cm}{1cm}](B)(C)
\tzpointangle(B)(A){\myAngA}
\tzpointangle(B)(C){\myAngC}
\tzarc(1,1)(\myAngA:\myAngC:10pt){\theta}[ar,midway]
\tzarc(1,1)(\myAngA:\myAngC:11pt)
\end{tikzpicture}

```

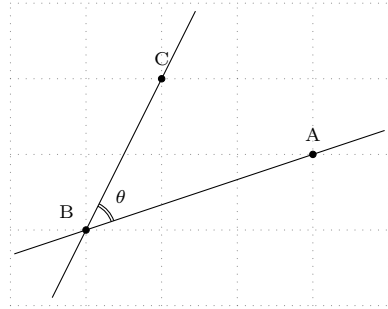

17.5.2 \tzanglemark('): Angle marks

\tzanglemark accepts three mandatory coordinates to display an angle mark by an arc (of radius 10pt, by default) for the second coordinate, on the **behind** layer by default. You can change the angle arc radius by \settzAAradius. You can change the layer by \settzanglelayer. Its alias is \settzanglemarklayer.

The default line width of angle marks is `very thin`. You can change the default line with with \settzAAlinestyle.

```

% syntax: minimum
\tzanglemark(<coorA>)(<coorB>)(<coorC>)
% syntax: full
\tzanglemark[<opt>](<coorA>)(<coorB>)(<coorC>){<text>}[<node opt>](<arc radius>)
% defaults
[very thin](<m>)(<m>)(<m>){}[pos=1.5](10pt)

```

You can add angle text by the options {<text>} and [<node opt>].

```

% simple example
\begin{tikzpicture}
\tzcoors*(4,2)(A){A}(1,1)(B){B}[180](2,3)(C){C} ;
\tzlines(A)(B)(C);
\tzanglemark(A)(B)(C){\theta} % angle mark
\end{tikzpicture}

```

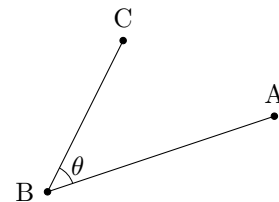

```

% \settzAAradius
\begin{tikzpicture}
\tzcoors(4,2)(A){A}(1,1)(B){B}[180](2,3)(C){C} ;
\tzlines(A)(B)(C);
\tzlines[thick,blue](A)(2.5,0)(C);
\tzanglemark(A)(B)(C){\theta} %%
\settzAAradius{20pt} %%
\tzanglemark(C)(2.5,0)(A){\alpha}[pos=.7] %%
\end{tikzpicture}

```

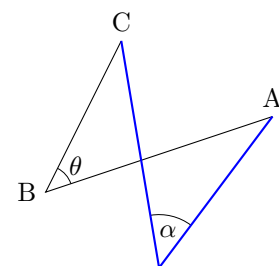

How it works Every \tzanglemark calculates angles (from 0° to 360°) and stores the values under the names \tzangleONE and \tzangleTWO. The difference of the two numbers is stored as an absolute value under the name \tzangleresult. Of course, you can use these values *only after* running \tzanglemark.

- \tzanglemark draws an angle mark between two angles, **counterclockwise**, from small to large.
- \tzanglemark' draws an angle mark between two angles, **clockwise**, from small to large.

```

\begin{tikzpicture}
\tzhelplices(4,3)
\tzcoors*(4,2)(A){A}(1,1)(B){B}[180](2,3)(C){C} ;
\tzlines(A)(B)(C);
\tzanglemark[->](A)(B)(C){$\theta$}
\tznode[scale=.7](3,1){ONE: \tzangleONE}[r]
\tznode[scale=.7](3,.5){TWO: \tzangleTWO}[r]
\tznode[scale=.7](3,0){$\theta$: \tzangleresult}[r]
\end{tikzpicture}

```

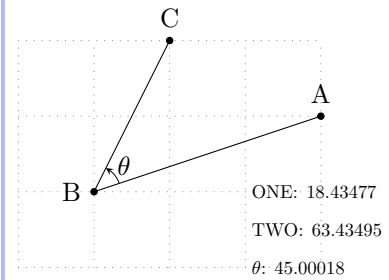

Remark: Simple to use:

- `\tzmarkangle(A)(B)(C)` draws an angle mark by an arc from (A) to (C) about (B).
- `\tzmarkangle(C)(B)(A)` draws an angle mark by an arc from (C) to (A) about (B).
- Ignoring the direction, `\tzanglemark(A)(B)(C)` and `\tzanglemark(C)(B)(A)` give the same result.

```

\begin{tikzpicture}
\tzhelplices(4,3)
\tzcoors*(4,2)(A){A}(1,1)(B){B}[180](2,3)(C){C} ;
\tzlines(A)(B)(C);
\tzanglemark[->](C)(B)(A){$\theta$}
\tznode[scale=.7](3,1){ONE: \tzangleONE}[r]
\tznode[scale=.7](3,.5){TWO: \tzangleTWO}[r]
\tznode[scale=.7](3,0){$\theta$: \tzangleresult}[r]
\end{tikzpicture}

```

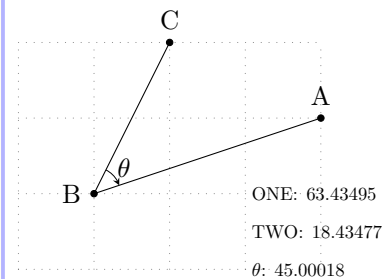

Swap version The *swap version* `\tzanglemark'` draws an angle mark for an angle in $360^\circ - \theta$. In other words, `\tzanglemark'` switches the direction of drawing an angle arc from counterclockwise to clockwise, and vice versa.

```

\begin{tikzpicture}
\tzhelplices(4,3)
\tzcoors*(4,3)(A){A}(1,2)(B)(3,0)(C){C}[0] ;
\tzlines[thick](A)(B)(C);
\tzanglemark[->](A)(B)(C){$\theta$}
\tznode[scale=.7](3,2){ONE: \tzangleONE}[r]
\tznode[scale=.7](3,1.5){TWO: \tzangleTWO}[r]
\tznode[scale=.7](3,1){$\theta$: \tzangleresult}[r]
\tzanglemark'[->](A)(B)(C){$\theta'$}(15pt) % swap
\end{tikzpicture}

```

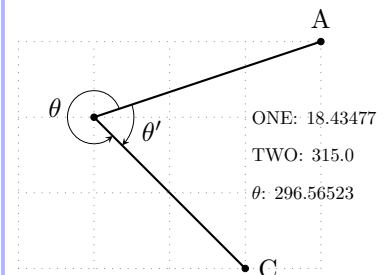

Angle mark text position The midpoint of an angle arc is stored under the coordinate name `tzAAamid`. The angle mark text is put on the line that goes through the middle point and (`tzAAamid`). The default `<arc radius>` is 10pt and the default position of angle text is `pos=1.5` in `[<node opt>]`.

```

% angle marc text position
\begin{tikzpicture}
\zhelplines(4,3)
\tzcoors*(4,2)(A){A}(1,1)(B){B}[180](2,3)(C){C} ;
\tzlines(A)(B)(C);
\tzanglemark(C)(B)(A){$\theta$}[pos=.65](20pt) %%
\tzdot*(tzAAmid)
\tzline[red,dashed,tzextend={1cm}{2cm}](B)(tzAAmid)
\end{tikzpicture}

```

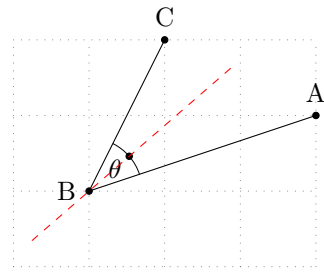

Remark: Instead of using the options `<text>` and `[<node opt>]`, you can also use the coordinate `(tzAAmid)` to place the angle text wherever you want, without using `\tzanglemark(')`. Of course, you can use the correct `(tzAAmid)` only after running `\tzanglemark`.

17.5.3 `\tzanglemark*(')`: Fill angle marks

`\tzanglemark*` fills (in the behind layer, by default) the angle mark area with `fill=black!50` and with the options `fill opacity=.3` and `text opacity=1` by default. It does not draw any lines: `[draw=none]` by default.

Using the macros such as `\settzfillcolor`, `\settzfillopacity`, and `\settzanglelayer`, you can change the default values.

```

% syntax: minimum
\tzanglemark*(<coorA>)(<coorB>)(<coorC>)
% syntax: full
\tzanglemark[<opt>](<coorA>)(<coorB>)(<coorC>){<text>}[<node opt>](<arc radius>)
% defaults
[very thin](<m>)(<m>)(<m>){}[pos=1.5](10pt)
% syntax
\tzanglemark*[<opt>](<coor1>)(<coor2>)(<coor3>)
<text>[<node opt>](<arc radius>){<fill opacity>}
% defaults
*[very thin,draw=none,fill=black!50,fill opacity=.3,text opacity=1]
(<m>)(<m>)(<m>){}[pos=1.5](10pt){.3}

```

```

% \tzanglemark*
\begin{tikzpicture}
\zhelplines(4,3)
\tzcoors*(4,2)(A){A}(1,1)(B){B}[180](2,3)(C){C} ;
\tzlines(A)(B)(C);
\tzanglemark*[red](C)(B)(A){$\theta$}
\end{tikzpicture}

```

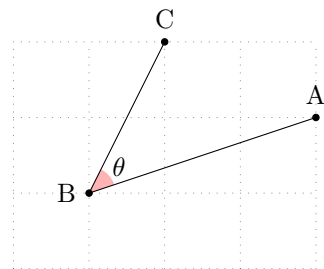

`\tzanglemark*` is the *swap* version of `\tzanglemark*`.

```

% \tzanglemark*(')
\begin{tikzpicture}
\zhelplines(4,3)
\tzcoors*(4,3)(A){A}(1,2)(B)(3,0)(C){C}[0] ;
\tzlines(A)(B)(C);
\tzanglemark*[red](A)(B)(C){$\theta$}
\tzanglemark*' [blue](A)(B)(C){$\theta'$}(15pt) % swap
\end{tikzpicture}

```

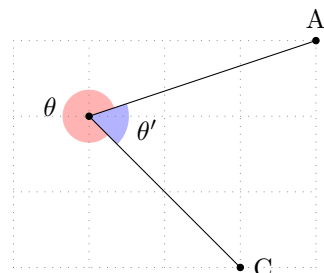

```

% \tzanglemark*('): \settzAAlinestyle
\begin{tikzpicture}
\settzAAlinestyle{thick}
\tzhelplines(4,3)
\tzcoors*(4,3) (A){A}(1,2) (B) (3,0) (C){C}[0] ;
\tzlines[thick,blue] (A) (B) (C);
\tzanglemark*[red] (A) (B) (C){$\theta$}
\tzanglemark(A) (B) (C)
\settzAAlinestyle{very thin} % default
\tzanglemark'(A) (B) (C) (14pt)
\tzanglemark'(C) (B) (A) (15pt){$\theta'$}
\end{tikzpicture}

```

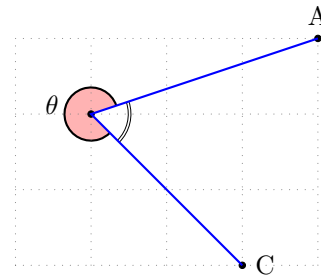

17.5.4 \tzrightanglemark: Right angle marks

`\tzrightanglemark` takes three coordinates as mandatory arguments to display a right angle mark for the second coordinate. The mark is drawn on the `behind` layer by default, which can be changed by `\settzanglelayer`.

The default line width is `very thin`, which can be changed by the option `[<opt>]`. You can also change the line width using `\settzRALinestyle`, which is valid until the end of `tikzpicture` environment. `\settzRALinestyle` is an alias of `\settzAAlinestyle`. The length of the side is `5pt` by default, and it can be changed by the last option (`<size>`). You can also change the size with `\settzRAsize`, which is valid until the end of the `tikzpicture` environment.

```

% syntax: minimum
\tzrightanglemark(<coorA>)(<coorB>)(<coorC>)
% syntax: full
\tzrightanglemark[<opt>](<coorA>)(<coorB>)(<coorC>){<text>}[<node opt>](<size>)
% defaults
[very thin](<m>)(<m>)(<m>){}[] (5pt)

```

```

% simple example (with angle text)
\begin{tikzpicture}[font=\scriptsize]
\tzhelplines(4,3)
\tzcoors(1,2) (A){A}(1,0) (B){B}[180] (4,0) (C){C}[0];
\tzlines(A) (B) (C);
\tzrightanglemark(A) (B) (C){90\textdegree}
\end{tikzpicture}

```

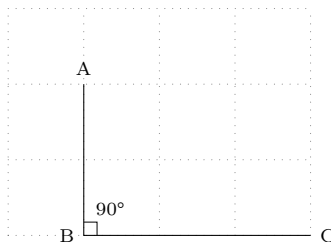

Remark:

- `\tzrightanglemark(A) (B) (C)` and `\tzrightanglemark(C) (B) (A)` give the same result.
- `\tzrightanglemark'` is redundant, but it is provided to avoid frequent coding errors.

Each `\tzrightanglemark` defines `(tzRAvertex)` as the coordinate of the right angle mark vertex. The angle text is placed on the line going through the second coordinate and `(tzRAvertex)`. The default position is `pos=2` in `[<node opt>]`.

```

% \settzRsize
\begin{tikzpicture}
\tzhelplices(4,3)
\tzcoors(2,3)(A){A}(1,1)(B){B}[180](3,0)(C){C}[0];
\tzlines(A)(B)(C);
\settzRsize{15pt}
\tzrightanglemark(A)(B)(C){90\textdegree}[pos=1.7]
\tzdot*(tzRAvertex)
\tzline[red,dashed,tzextend={2mm}{2cm}](B)(tzRAvertex)
\end{tikzpicture}

```

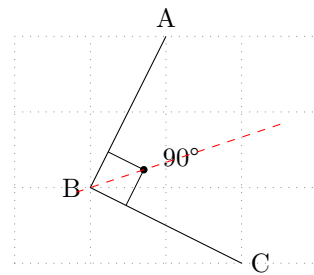

Remark: You can also use the coordinate (tzRAvertex) to place angle text wherever you want, after \tzrightanglemark.

17.5.5 \tzrightanglemark*: Fill right angle marks

The starred version \tzrightanglemark* fills the interior of right angle marks with `fill=black!50`, with `fill opacity=.3` and `text opacity=1`. It does not draw any line: `[draw=none]` by default. The filled mark is drawn on the behind layer by default, which can be changed by \settzanglelayer. Its alias is \settzanglemarklayer.

```

% syntax: minimum
\tzrightanglemark*(<coorA>)(<coorB>)(<coorC>)
% syntax: full
\tzrightanglemark* [<opt>] (<coorA>)(<coorB>)(<coorC>)
                    {<text>}[<node opt>](<size>){<fill opacity>}
% defaults
*[draw=none,very thin,fill=black!50,fill opacity=.3,text opacity=1]
(<m>)(<m>)(<m>){}[] (5pt){.3}

```

With \settzfillcolor and \settzfillopacity, you can also change the default fill color and fill opacity.

```

% \rightanglemark*
\begin{tikzpicture}[scale=.8,font=\scriptsize]
\tzhelplices(5,5)
\tzcoorsquick(0,5)(A)(4,0)(B)(0,1)(C)(5,5)(D);
\tzline"AB"(A)(B)
\tzline"CD"(C)(D)
\tzXpoint{AB}{CD}(E)
\tzrightanglemark*(A)(E)(D){90\textdegree}
\tzrightanglemark*[red](A)(E)(C)(20pt)
\tzrightanglemark*[draw=blue,fill=green](B)(E)(C)(20pt)
\end{tikzpicture}

```

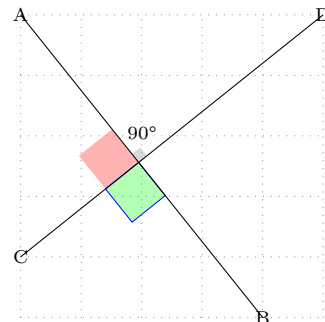

```

% \settzRAsize
\begin{tikzpicture}[scale=.8,font=\scriptsize]
\tzhelplines(5,5)
\tzcoorsquick(0,5)(A)(4,0)(B)(0,1)(C)(5,5)(D);
\tzline[dotted]"AB"(A)(B)
\tzline[dotted]"CD"(C)(D)
\tzXpoint{AB}{CD}(E)
\settzRAsize{20pt} %%
\tzrightanglemark*[red](A)(E)(D){\rho}[pos=1.3]
\tzrightanglemark[blue,thin](A)(E)(D)
\tzrightanglemark*[draw=blue,thin,fill=green](B)(E)(C)
\end{tikzpicture}

```

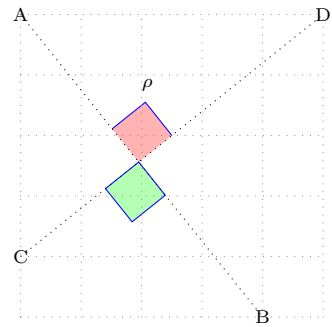

17.6 \tzdistance: Distances and changes

`\tzdistance(<coor1>)(<coor2>){<mylength>}` calculates the Cartesian distance *from* (`<coor1>`) *to* (`<coor2>`) and stores the (absolute) value to the user-specified macro `\mylength` in centimeters. And `\tzdistance` also stores the changes in x and y to `{<\Deltax>}` and `{<\Deltay>}`, respectively. Note that the calculated distance is *approximate*.

```

% syntax: minimum
\tzdistance(<coorA>)(<coorB>){<mylength>}
% syntax: full
\tzdistance(<coorA>)(<coorB>){<mylength>}{<\Deltax>}{<\Deltay>}
% defaults:
(<m>)(<m>){<m>}{-}{-}

```

```

% \tzdistance
\begin{tikzpicture}
\tzhelplines(4,3)
\tzcoors*(0,0)(A)(4,0)(B)(0,3)(C);
\tzdistance(A)(B){\lenA}
\tzdistance(B)(C){\lenB}
\tzpolygon(A){\lenA}[b](B){\lenB}[sloped,a](C);
\end{tikzpicture}

```

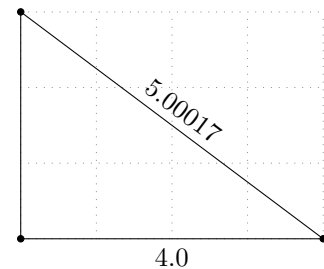

```

% \tzdistance, \tzpointangle
\begin{tikzpicture}
\tzhelplines(4,3)
\tzcoors*(1,0)(A){A}[180](3,1)(B){B}[0];
\tzdistance(A)(B){\lenA}{\xdist}{\ydist}
\tzpointangle(A)(B){\angA}
\tzline[red](A)(B)
\tzarc[blue](A){\angA:90:\lenA}
\tzline+[->]<0,-.5>(A){\xdist,0}
\tzline+[->]<1,0>(A-|B)(0,\ydist)
\end{tikzpicture}

```

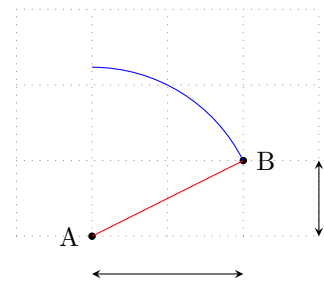

```

% \Delta: (+), \Delta: (-)
\begin{tikzpicture}
\zhelplines(4,3)
\tzcoors*(1,2)(A){A}[180](3,1)(B){B}[0];
\tzdistance(A)(B){\lenA}{\xdist}{\ydist} % A to B
\tzpointangle(A)(B){\angA}
\tzline[red](A)(B)
\tzarc[->,blue](A){\angA:90:\lenA}
\tzline+[|->|<0,-.5>(A|-B)
          {\Delta\x=\xdist}[b]
          (\xdist,0)
\tzline+[|->|<-1,0>(A)(0,\ydist)
\end{tikzpicture}

```

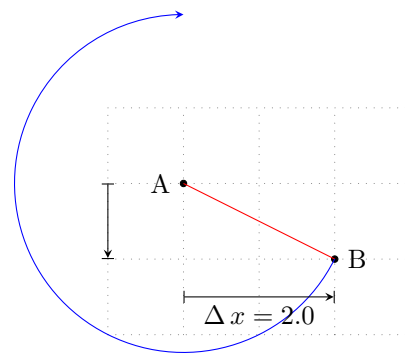

```

% \Delta: (-), \Delta: (+)
\begin{tikzpicture}
\zhelplines(4,3)
\tzcoors*(1,2)(A){A}[180](3,1)(B){B}[0];
\tzdistance(B)(A){\lenA}{\xdist}{\ydist} % B to A
\tzpointangle(B)(A){\angA}
\tzline[red](B)(A)
\tzarc'[->,blue](A){\angA-180:90:\lenA}
\tzline+[|->|<0,-.5>(B)
          {\Delta\x=\xdist}[b]
          (\xdist,0)
\tzline+[|->|<-1,0>(B|-A)(0,\ydist)
\end{tikzpicture}

```

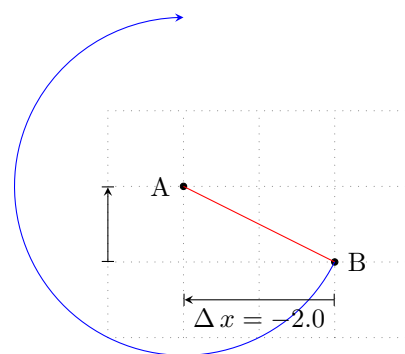

Part IV Plotting Graphs

18 Axes

18.1 Draw axes

18.1.1 `\tzaxes`

Basically, `\tzaxes(<x1,y1>)(<x2,y2>)` draws the x axis from $<x1>$ to $<x2>$ and the y axis from $<y1>$ to $<y2>$. The coordinate $(<x1,y1>)$ represents the origin and $(<x2,y2>)$ represents the opposite corner of the rectangle formed by the two coordinates.

`\tzaxes` takes only one coordinate $(<x2,y2>)$ as a mandatory argument, in which case the coordinate $(<x1,y1>)$ is considered as $(0,0)$.

```
% syntax: minimal
\tzaxes(<x2,y2>){<x-axis label>}{<y-axis label>}
% syntax: full
\tzaxes[<opt>]<x-shift,y-shift>"<path name>"(<x1,y1>)(<x2,y2>)
    {<x-axis label>}[<node opt>]{<y-axis label>}[<node opt>]
% defaults
[-><0,0>"axes"(0,0)(<m>){}[right]{}[above]
% arguments
[#1]: line style, arrow type (for x-axis & y-axis)
<#2>: axes shift coor      %% axes intersect at (#2)
"#3": name path=#3        %% default: axes
(#4): (x1,y1)              %% origin: if omitted, regarded as (0,0)
(#5): (x2,y2)              %% opposite corner: mandatory
{#6}: x-axis label
[#7]: x-axis label option  %% node option
{#8}: y-axis label
[#9]: y-axis label option  %% node option
```

Here, $(<m>)$ stands for a mandatory argument.

```
% tzaxes
\begin{tikzpicture}[scale=.7]
\tzhelplines(4,3)
\tzaxes(4,3){$x$}{$y$}
\end{tikzpicture}
```

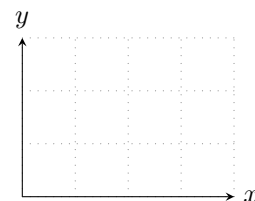

Shift By default, the x and y axes intersect at $(0,0)$. Specifying the option `<x-shift,y-shift>` shifts the axes to intersect at $(<x-shift,y-shift>)$.

```
% tzaxes: intersects at (1,.5)
\begin{tikzpicture}[scale=.7]
\tzhelplines(4,3)
\tzaxes<1,.5>(4,3){$x$}{$y$}
\end{tikzpicture}
```

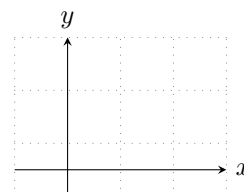

```

% \tzaxes: shift
\begin{tikzpicture}[scale=.5]
\tzhelplines(-1,-1)(7,7)
\tzshoworigin*
\tzaxes[thick,blue]<1,2>(7,7){$x$}{$y$} %%
\tzaxes[-,dashed](7,7){$X$}[below]{$Y$}[left]
\tzaxes<6,1>(6,1)(3,6){$a$}[left]{$b$} %%
\end{tikzpicture}

```

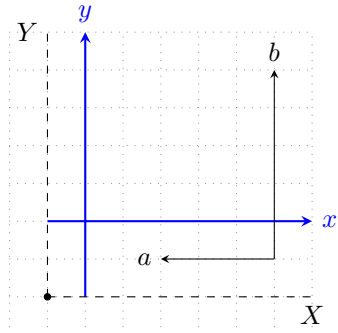

name path With the option "<path name>", you can name the path of `\tzaxes` (by default, axes). This makes it easy to find *x-intercepts* and *y-intercepts* of a graph.

```

% \tzaxes; name path=axes (by default)
\begin{tikzpicture}
\tzhelplines(-1,-1)(3,3)
\tzaxes(-1,-1)(3,3){$x$}{$y$}
\tzline"line"(-1,2)(3,-.5)
\tzXpoint{axes}{line}(K) %% default: axes
\tzdot*(K)
\tzdot(K-2)
\end{tikzpicture}

```

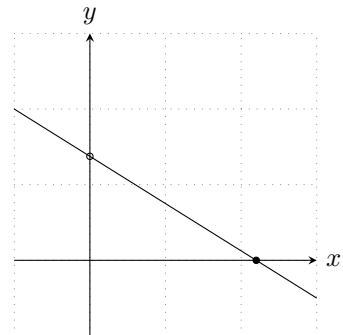

The x-intercepts are found first and then the y-intercepts are found, as in the following example.

```

\begin{tikzpicture}[scale=.7]
% \tzaxes: name path
\tzhelplines(-2,-2)(5,5)
\tzaxes"myaxes"(-2,-2)(5,5) %% name path = myaxes
\tzparabola"curve"(-2,-2)(1,4)(5,-1)
\tzXpoint{myaxes}{curve}(K) %%
\tzdot*(K){$A$}
\tzdot(K-2){$B$}
\tzdot(K-3){$C$}
\end{tikzpicture}

```

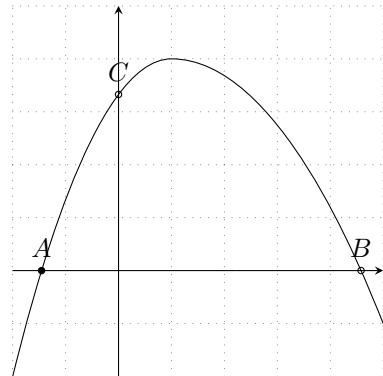

18.1.2 \tzaxes*

The starred version `\tzaxes*` sets the current state to a *bounding box* when the macro `\tzaxes` execution is complete. It is recommended for you to use `\tzaxes*` as the first graphics command in `tikzpicture` environment or before any larger graphics.

```

\begin{tikzpicture}[scale=.5]
\tzaxes*(8,5){$x$}{$f(x)$} %% bounding box
\tzhelplines(-2,-1)(10,8)
\tzto[out=90,in=-135,dashed](-2,8)(12,-2)
\tzbezier[blue](-1,-1)(3,-2)(7,12)(10,10)
\end{tikzpicture}

```

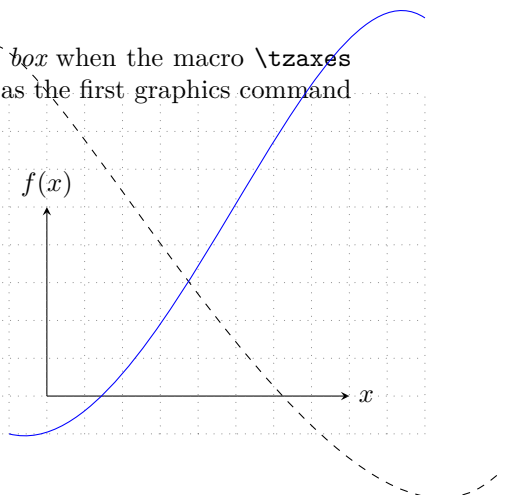

18.2 \tzaxisx and \tzaxisy

\tzaxisx draws only the x axis.

```
% syntax
\tzaxisx [<opt>]<y-shift>"<path name>"{<from>}{<to>}
        {<x-axis label>}[<node opt>]
% defaults
[->]<0>"axisx"{<m>}{<m>}{}[right]
% arguments:
[#1]: line style, arrow type (for x-axis)
<#2>: y-shift of x-axis
"#3": name path = #3      %% default: axisx
{#4}: x-axis starts from %% <m>
{#5}: x-axis runs to     %% <m>
{#6}: x-axis label
{#7}: x-axis label option %% node option
```

\tzaxisy draws only the y axis.

```
% syntax
\tzaxisy [<opt>]<x-shift>"<path name>"{<from>}{<to>}
        {<y-axis label>}[<node opt>]
% defaults
[->]<0>"axisy"{<m>}{<m>}{}[right]
% arguments:
[#1]: line style, arrow type (for y-axis)
<#2>: x-shift of y axis
"#3": name path = #3      %% default: axisy
{#4}: y-axis starts from %% <m>
{#5}: y-axis runs to     %% <m>
{#6}: y-axis label
{#7}: y-axis label option %% node option
```

```
% \tzaxisx, \tzaxisy
\begin{tikzpicture}[scale=.5]
\tzshoworigin
\tzhelplines(5,5)
\tzaxisx[blue]{-1}{5}{$xx$}
\tzaxisy[red]{-1}{5}{$yy$}[green]
\end{tikzpicture}
```

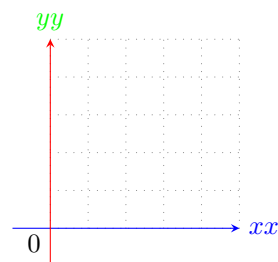

```
% \tzaxisx, \tzaxisy: shift
\begin{tikzpicture}[scale=.5]
\tzhelplines(7,7)
\tzshoworigin
\tzaxisx{-1}{7}{$xx$}[very near end,below]
\tzaxisy{-1}{7}{$yy$}[midway,sloped,auto]
\tzaxisx[-,dashed,red]<2>{-1}{7}{$xx'$}[blue]
\tzaxisy[-,dashed,blue]<3>{-1}{7}{$yy'$}
\end{tikzpicture}
```

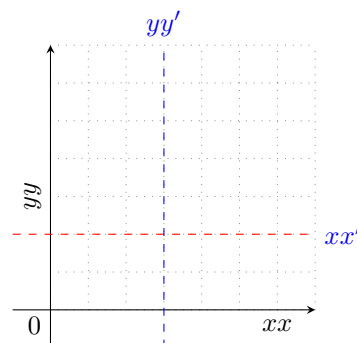

With the option "<path name>", you can name each path of \tzaxisx and \tzaxisy (by default, axisx and axisy, respectively).

```

% name path = axisx, axisy (defaults)
\begin{tikzpicture}[scale=.5]
\tzhelplines(7,7)
\tzshoworigin
\tzaxisx{-1}{7}{$xx$}[near start,below]
\tzaxisy{-1}{7}{$yy$}[midway,sloped,auto]
%\tzaxisx[-,dashed,red]<2>{-1}{7}{$xx'$}[blue]
%\tzaxisy[-,dashed,blue]<3>{-1}{7}{$yy'$}
\tzLFn"line"(1,3)(5,0)[-1:6]
\tzXpoint*{line}{axisx}(A){$A$}
\tzXpoint*{line}{axisy}(B){$B$}[0]
\end{tikzpicture}

```

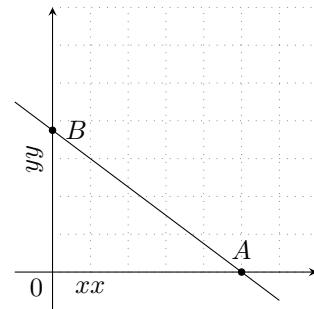

```

% name path = axisx, axisy (defaults)
\begin{tikzpicture}[scale=.5]
\tzhelplines(7,7)
\tzshoworigin
\tzaxisx{-1}{7}{$xx$}[near start,below]
\tzaxisy{-1}{7}{$yy$}[midway,sloped,auto]
\tzaxisx[-,dashed,red]<2>{-1}{7}{$xx'$}[blue]
\tzaxisy[-,dashed,blue]<3>{-1}{7}{$yy'$}
\tzLFn"line"(1,3)(5,0)[-1:6]
\tzXpoint*{line}{axisx}(A){$A$}
\tzXpoint*{line}{axisy}(B){$B$}[0]
\end{tikzpicture}

```

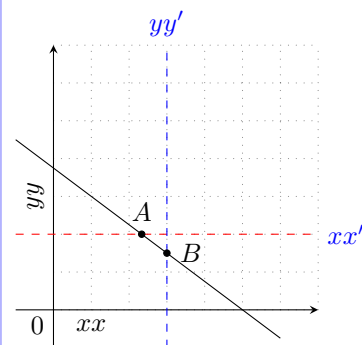

18.3 Display the origin

18.3.1 \tzshoworigin

\tzshoworigin prints '0' (approximately) at the bottom left of the origin (0,0), by default.

```

% syntax
\tzshoworigin<shift coor>(<origin>){<text>}[<node opt>]
% default
<>(0,0){0}[below left,text height=1.25ex,text depth=.25ex]

```

All arguments of \tzshoworigin are optional.

```

% \tzshoworigin
\begin{tikzpicture}[scale=.45]
\tzhelplines(8,5)
\tzshoworigin
\tzaxes(8,5)
\end{tikzpicture}

```

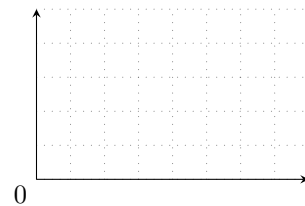

You can change the text by specifying the curly brace option {<text>}, like, for example, \tzshoworigin{0\$}. You can also change the coordinate of origin by the option (<origin>). Specifying the option <shift coor> also moves the origin.

```

% \tzshoworigin: shift
\begin{tikzpicture}[scale=.45]
\tzhelplines(-2,-1)(8,6)
\tzshoworigin{ $O_1$ } %%
\tzaxes(8,6){ $x$ }{ $y$ }
\tzshoworigin<2,1>{ $O_2$ }[red] %%
\tzaxes[dashed]<2,1>(8,6)
\end{tikzpicture}

```

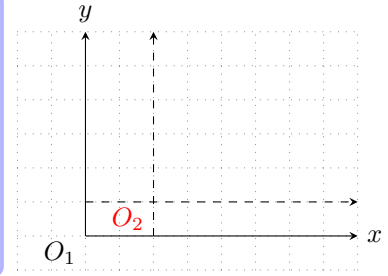

18.3.2 \tzshoworigin*

\tzshoworigin* prints a node dot at the origin with no text by default. Internally the dot is processed by \tzdot*. All arguments are optional.

```

% syntax
\tzshoworigin* [<dot opt>] <shift coor> (<origin>) {<text>} [<node opt>] (<dot size>)
% default
* [] <> (0,0) {} [below left, text height=1.25ex, text depth=-.25ex] (2.4pt)

```

```

% \tzshoworigin*
\begin{tikzpicture}[scale=.45]
\tzhelplines(-2,-1)(6,4)
\tzshoworigin*
\tzaxes(-2,-1)(6,4)
\end{tikzpicture}

```

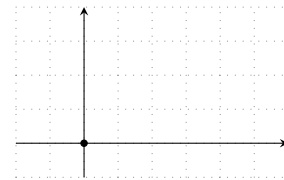

You can add text with the option {<text>}. The default size of the dot is 2.4pt, and it can be changed with the last option (<dot size>). You can change the dot style using the first optional argument [<dot opt>]. You can also move the dot by specifying the option <shift coor>.

```

% \tzshoworigin*
\begin{tikzpicture}[scale=.5]
\tzhelplines(-1,-1)(7,7)
\tzshoworigin*[blue]{ $O_1$ }[red] (5pt)
\tzaxes(-1,-1)(7,7){ $x$ }{ $y$ }
\tzaxes<6,4>(6,4)(1,1){ $x'$ }[left]{ $y'$ }[below]
\tzshoworigin*[fill=none]<6,4>{ $O'$ }[blue,ar] (3pt)
\end{tikzpicture}

```

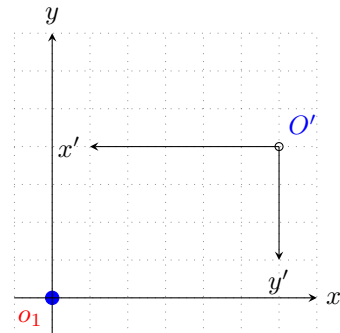

Remark: For \tzshoworigin*, text for the origin and the dot are placed independently. In other words, the position of node text does not depend on the size of a node dot. (In fact, the node text for the origin should look good with the ‘ticks labels’, so it was not designed as a label for the node dot. This also means that the origin text cannot be positioned by an <angle>.)

```

% \tzshoworigin* (with tick labels)
\begin{tikzpicture}[scale=.5]
\tzhelplines(-2,1)(6,5)
\tzshoworigin*{0} (5pt)
\tzaxes(-2,-1)(6,5){ $x$ }{ $y$ }
\tzticks{1,...,5}{1,...,4}
\end{tikzpicture}

```

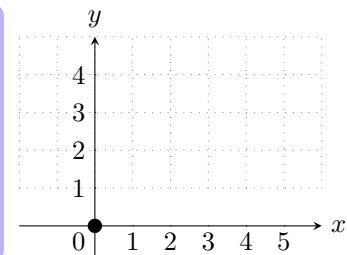

18.4 \tzaxesL('): L-type axes

\tzaxesL is similar to \tzaxes, but it draws only the 'L' type axes with $(\langle x1,y1 \rangle)$ as the origin and $(\langle x2,y2 \rangle)$ as the opposite corner of the rectangle. Those two coordinates are mandatory.

```
% syntax
\tzaxesL[<opt>]<shift coor>"<path name>"(<x1,y1>)(<x2,y2>)
    {<x-axis label>}[<node opt>]{<y-axis label>}[<node opt>]
% defaults
[]<>"axesL"(<m>)(<m>){}[right]{}[above]
% arguments:
[#1]: line style, arrow type
<#2>: shift coordinate
"#3": name path=#3          %% default: axesL
(#4): (x1,y1)                %% mandatory
(#5): (x2,y2)                %% mandatory
{#6}: x-axis label
[#7]: x-axis label option %% node option
{#8}: y-axis label
[#9]: y-axis label option %% node option
```

The *swap version* \tzaxesL' swaps $(\langle x1,y1 \rangle)$ and $(\langle x2,y2 \rangle)$. That is, \tzaxesL' (A) (B) is equivalent to \tzaxesL(B) (A).

```
% \tzaxesL, \tzaxesL'
\begin{tikzpicture}[scale=.5]
\tzhelplines(8,7)
\tzshoworigin
\tzaxes(8,7){$x$}{$y$}
\tzaxesL[red,thick](2,2)(6,5){$a$}{$b$}
\tzaxesL'[blue,dashed,->](2,2)(6,5){$c$}{$d$}
\tzaxesL'[->](7,1)(4,7){m}[draw,r]{n}[draw,circle]
\end{tikzpicture}
```

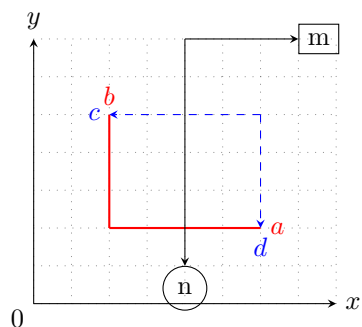

Shift The option <shift coor> moves the whole L-type axes. The empty option <> is not allowed.

```
% \tzaxesL, \tzaxesL': shift
\begin{tikzpicture}[scale=.5]
\tzhelplines(8,7)
\tzshoworigin
\tzaxes(8,7){$x$}{$y$}
\tzaxesL[red,thick](2,2)(6,5){$a$}{$b$}
\tzaxesL[red,thick]<.5,.5>(2,2)(6,5){$a'$}{$b'$}
\tzaxesL'[blue,dashed,->](2,2)(6,5){$c$}{$d$}
\tzaxesL'[blue,dashed,->]<-1,-1>(2,2)(6,5){$c'$}{$d'$}
\end{tikzpicture}
```

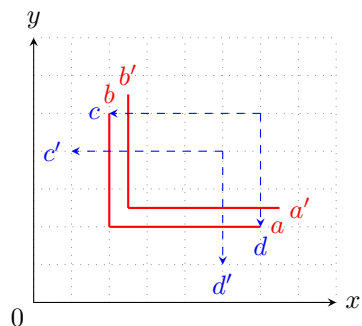

name path With the option "<path name>", you can name the path of \tzaxesL (by default, axesL). This makes it easy to find the intercepts.

```

% \tzaxesL: name path (by default, axesL)
\begin{tikzpicture}[scale=.5]
\tzhelpelines(8,7)
\tzshoworigin
\tzaxes(8,7){$x$}{$y$}
\tzaxesL[red,thick](2,2)(6,5){$a$}{$b$}
\tzaxesL'[blue,dashed,->]<-1,-1>(2,2)(6,5){$c'$}{$d'$}
\tzparabola"curve"(1,6)(3,1.5)(6,5)
\tzXpoint{axesL}{curve}(K) % default: axesL
\tzdot*(K)
\tzdot(K-2)
\end{tikzpicture}

```

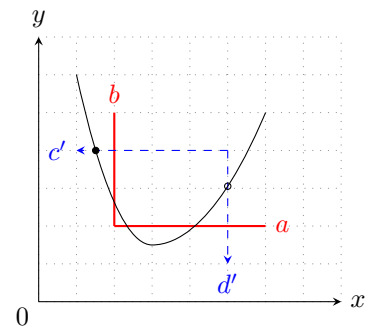

19 Ticks

19.1 \tzticks: Tick labels

By default, `\tzticks` prints tick labels and draws zero length tick marks, i.e. from (0pt) to (0pt).

```

% syntax: minimal
\tzticks{<x-ticks pos>}{<y-ticks pos>}
% syntax: medium
\tzticks(<x-from:x-to>){<x-ticks pos/labels>}[<node opt>]
      (<y-from:y-to>){<y-ticks pos/labels>}[<node opt>]
% syntax: full
\tzticks[<opt>]<x-shift,y-shift>
      (<x-from:x-to>){<x-ticks pos/labels>}[<node opt>]
      (<y-from:y-to>){<y-ticks pos/labels>}[<node opt>]
% defaults
[]<0,0>{<opt>:<opt>}{<m>}[text height=1.25ex,text depth=.25ex,below]{<opt>:<opt>}{}[left]

```

Tick labels Internally, `\tzticks` uses TikZ's `foreach` operation. So you need to provide comma separated lists to print tick labels. If only one comma separated list is specified, it is for x tick labels.

```

% \tzticks
\begin{tikzpicture}[scale=.4,font=\scriptsize]
\tzhelpelines(10,10)
\tzaxes(-1,-1)(10,10)
\tzticks[blue]{1,...,8}{2,...,7}
\end{tikzpicture}

```

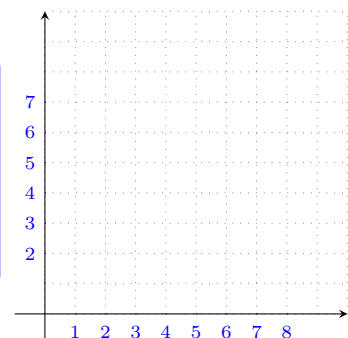

You can change the numbered labels to a different format with slashes and other text, as follows: `<number>/<other text>`.

```

% \zticks: tick labels
\begin{tikzpicture}[scale=.4,font=\scriptsize]
\zhelplines(10,10)
\tzaxes(-1,-1)(10,10)
\zticks{1/$x_1$,2,5/$x_2$,8/y}[blue]
        {2/$\sqrt{x}$,3/y,4/m,5,7/$k$}[red]
\end{tikzpicture}

```

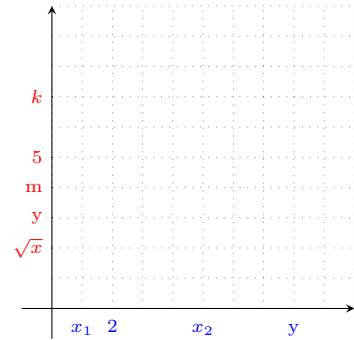

Tick marks By specifying the options ($\langle x\text{-from}:x\text{-to}\rangle$) for x ticks and/or ($\langle y\text{-from}:y\text{-to}\rangle$) for y ticks, you can print tick marks. (The default is (0pt:0pt) for both options.)

```

% \zticks: tick marks with (<a pt:b pt>)
\begin{tikzpicture}[scale=.4,font=\scriptsize]
\zhelplines(10,10)
\tzshoworigin
\tzaxes(-1,-1)(10,10)
\zticks[draw=red,thick]
        (-15pt:10pt){1,...,5,6/$k$,7/$\alpha$,8/$\beta$}
        (0pt:3cm) {2,...,6,7/$\gamma$}
\end{tikzpicture}

```

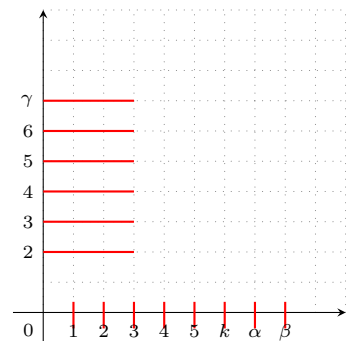

The position of tick labels does not depend on the length of the tick marks. You can change the position of tick labels using [$\langle \text{node opt}\rangle$].

```

% \zticks: position of tick labels
\begin{tikzpicture}[scale=.4,font=\scriptsize]
\zhelplines(10,10)
\tzshoworigin
\tzaxes(-1,-1)(10,10)
\zticks[draw=red,thick]
        (-15pt:10pt){1,...,6,7/$t$,8/$\alpha$}[b=5pt]
        (0pt:3cm) {2,...,6,7/$\beta$}
\end{tikzpicture}

```

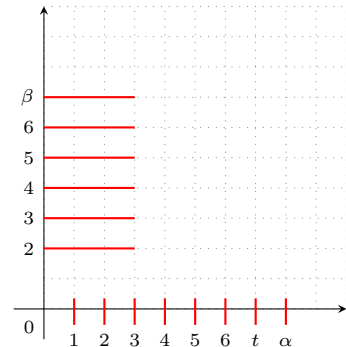

Shift You can move (or shift) the tick marks and labels together by specifying the optional argument $\langle x\text{-shift},y\text{-shift}\rangle$, where $\langle x\text{-shift}\rangle$ is for y -ticks and $\langle y\text{-shift}\rangle$ is for x -ticks.

```

% \zticks: shift
\begin{tikzpicture}[scale=.4,font=\scriptsize]
\zhelplines(10,10)
\tzshoworigin
\tzaxes(-1,-1)(10,10)
\tzaxes[dashed]<4,2>(-1,-1)(10,10)
\zticks[draw=red]<4,2>
        (-5pt:10pt){5,...,8}
        (0pt:3cm) {3,...,7}
\end{tikzpicture}

```

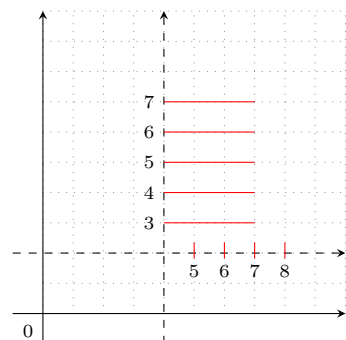

19.2 \zticks*: Tick marks

The starred version `\zticks*` always ignores all tick labels and draws tick marks from `0pt` to `3pt`, by default.

```
% syntax: minimal
\zticks*{<x-ticks pos>}{<y-ticks pos>}
% syntax: medium
\zticks*(<x-from:x-to>){<x-ticks pos>}<y-from:y-to>){<y-ticks pos>}
% syntax: full
\zticks* [<opt>] <x-shift,y-shift>
          (<x-from:x-to>){<x-ticks pos>}(<y-from:y-to>){<y-ticks pos>}
% defaults
[] <0,0>(0pt:3pt){<m>}(0pt:3pt){}
% starred(*) version always suppresses tick labels
```

```
% \zticks*
\begin{tikzpicture}[scale=.4,font=\scriptsize]
\zhelplines(10,10)
\tzshoworigin
\tzaxes(-1,-1)(10,10)
\zticks*[draw=red,thick]
          {1,...,7,8/ $\alpha$} % labels ignored
          (0pt:3cm){2,...,6,7/ $\beta$} % labels ignored
\end{tikzpicture}
```

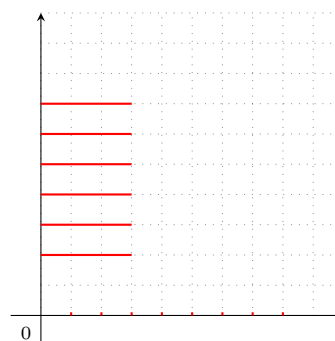

```
% \zticks(*)
\begin{tikzpicture}[scale=.5]
\zhelplines(10,8)
\tzaxes(-1,-1)(10,8)
\zticks*
  {0,0.2,...,8}
  {0,0.2,...,7} % default (Opt:3pt)
\zticks*
  (Opt:10pt){1,...,8}
  (Opt:10pt){1,...,7}
\zticks
  {1,...,8}
  {2,...,7} % default (Opt:Opt)
\end{tikzpicture}
```

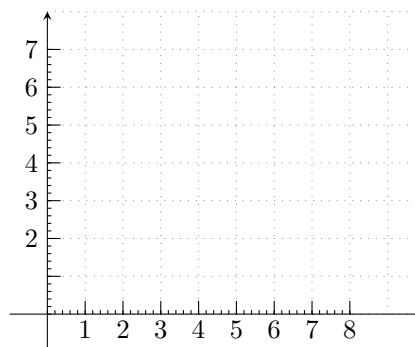

19.3 \zticksx(*) and \zticksy(*)

You can handle x ticks and y ticks independently.

X ticks `\zticksx` only prints x -tick labels but not tick marks, by default. To print tick marks you need to specify `(<x-from>:<x-to>)`.

```
% syntax:
\zticksx [<opt>] <y-shift> (<from>:<to>){<x-tick pos/labels>} [<node opt>]
% defaults
[] <>(0pt:0pt){<m>} [text height=1.25ex,text depth=.25ex,below]
```

`\zticksx*` only prints x-tick marks from 0pt to 3pt, by default, suppressing tick labels.

```
% syntax:
\zticksx* [<opt>] <y-shift> (<from>:<to>) {<xtick pos>}
% defaults
* [] <> (Opt:3pt) {<m>}
% starred(*) version always suppresses tick labels
```

Y ticks `\zticksy` only prints y-tick labels but not tick marks, by default. To prints tick marks you need to specify (<x-from>:<x-to>).

`\zticksy*` only prints y-ticks from 0pt to 3pt by default, suppressing tick labels.

```
% syntax:
\zticksy [<opt>] <x-shift> (<from>:<to>) {<y-ticks pos/labels>} [<node opt>]
% defaults
[] <> (Opt:0pt) {<m>} []
```

```
% syntax:
\zticksy* [<opt>] <x-shift> (<from>:<to>) {<y-ticks pos>}
% defaults
[] <> (Opt:0pt) {<m>}
% starred(*) version suppresses tick labels
```

```
% \zticka(*), \zticky(*)
\begin{tikzpicture}[scale=.4,font=\scriptsize]
\zhelplines(10,10)
\tzshoworigin
\tzaxes(-1,-1)(10,10)
\zticksx [draw=red,thick]
(-5pt:1cm){1,...,7,8/\alpha$}
\zticksy* [draw=blue,thick]
(Opt:3cm){2,...,6,7/\beta$} % labels ignored
\end{tikzpicture}
```

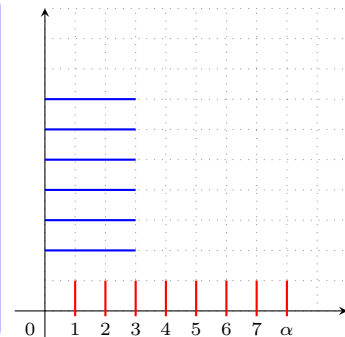

Shift The options <y-shift> and <x-shift> move x-ticks and y-ticks, respectively.

```
% \zticka(*), \zticky(*): shift
\begin{tikzpicture}[scale=.4,font=\scriptsize]
\zhelplines(10,10)
\tzshoworigin
\tzaxes(-1,-1)(10,10)
\tzaxes [dashed] <2,1> (-1,-1)(10,10)
\zticksx* [draw=red,thick]
<1> (-5pt:10pt){1,...,7,8/\alpha$} % labels ignored
\zticksy [draw=blue,thick]
<2> (Opt:3cm){2,...,6,7/\beta$}
\end{tikzpicture}
```

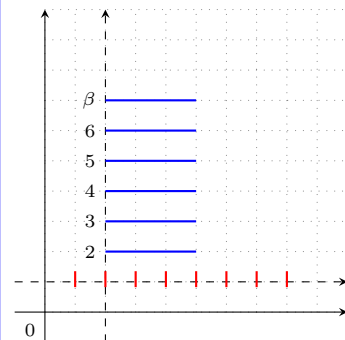

20 Projections

20.1 `\tzproj(*)`: Projections on the axes

`\tzproj` accepts a mandatory coordinate and draws perpendicular lines onto each axis from the coordinate. The lines are dotted, by default.

```
% syntax: minimum
\tzproj(<coord>)
% syntax: medium
\tzproj*(<coord>){<x-text>}[<node opt>]{<y-text>}[<node opt>]
% syntax: full
\tzproj* [<opt>] <x-shift,y-shift> (<coord>)
    {<x-text>}[<node opt>]{<y-text>}[<node opt>](<dot size>)
% defaults
* [dotted] <0,0> (<m>) {} [text height=1.25ex,text depth=.25ex,below] {} [left] (2.4pt)
```

`\tzproj*` additionally prints a ‘black node dot’ of the size 2.4pt, by default. Internally, the node dot is processed by `\tzdot*`. The first option [`<opt>`] does not control the node dot.

Dot size You can only control the size of dots by the last optional argument (`<dot size>`) or by the THREE WAYS on page 46. If you want to control fill or color of dots, use `\tzdot*` separately.

```
% \tzproj(*)
\begin{tikzpicture}[scale=.5]
\tzaxes(8,6)
\tzproj[dashed,blue](2,3)
\tzcoors(30:7)(A)(50:6)(B);
\tzproj*(A)
\tzproj*[dashed,text=blue](B)(5pt)
\end{tikzpicture}
```

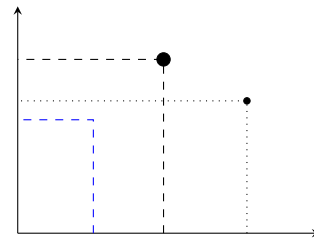

Adding text You can also add text around the projection point on each axis by the option `{<text>}`. The position and color of the text is controlled by the option [`<node option>`]. The default position is (approximately) `[below]` for the x axis and `[left]` for the y axis.

```
% \tzproj(*): adding text
\begin{tikzpicture}[scale=.5]
\tzhelplines(8,6)
\tzaxes(8,6)
\tzproj[dashed,blue](2,3){$x$}{$y$}
\tzcoors(30:7)(A)(50:6)(B);
\tzproj*[text=blue](A){$a_1$}{$a_2$}
\tzproj*[dashed](B){$x^*$}[green]{$y^*$}[red]
\end{tikzpicture}
```

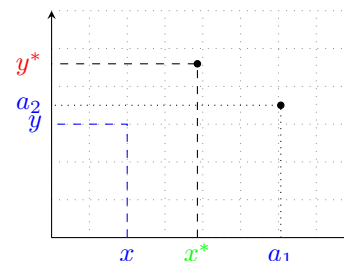

Projection shift Specifying the option `<x-shift,y-shift>` moves the projection point and text on each axis.

```

% \tzproj(*): projection shift
\begin{tikzpicture}[scale=.5]
\tzhelplines(8,6)
\tzaxes(8,6)
\tzproj[dashed,blue](2,3){$x$}{$y$}
\tzcoors(30:7)(A)(50:6)(B);
\tzaxes[blue]<3,1>(8,6)
\tzproj*[dashed,text=blue]<3,1>(A){$a_1$}{$a_2$} %%
\end{tikzpicture}

```

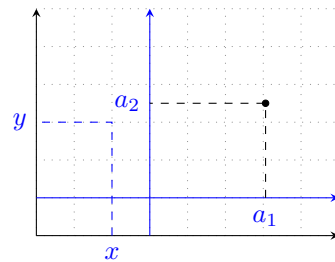

20.2 \tzprojx(*) and \tzprojy(*)

\tzprojx draws a dotted line, which is perpendicular to the x axis.

\tzprojx* additionally prints a ‘black node dot’ of the size 2.4pt, by default.

```

% syntax:
\tzprojx[<opt><x-shift,y-shift>(<coor>){<x-text>}[<node opt>](<dot size>)
% defaults
[]<0,0>(<m>){}[text height=1.25ex,text depth=.25ex,below](2.4pt)

```

\tzprojy draws a dotted line, which is perpendicular to the y axis.

\tzprojy* additionally prints a ‘black node dot’ of the size 2.4pt, by default.

```

% syntax:
\tzprojy[<opt><x-shift,y-shift>(<coor>){<y-text>}[<node opt>](<dot size>)
% defaults
[]<0,0>(<m>){}[left](2.4pt)

```

You can only control the size of dots by the last option (<dot size>). If you want to control fill or color of dots, use \tzdot* separately. You can also add text around the projection point on each axis by specifying the option {<x-text>} or {<y-text>} followed by the option [<node option>].

```

% \tzprojx(*), \tzprojy(*)
\begin{tikzpicture}[scale=.5,font=\scriptsize]
\tzhelplines(-1,-2)(6,6)
\tzshoworigin
\tzaxes(-1,-1)(6,6)
\tzproj*[dashed](4,5){4}{5}(3pt)
\tzprojx*[green,thick,solid](3,4){$x=3$}[blue]
\tzprojy*[thick](5,2){2}(5pt)
\end{tikzpicture}

```

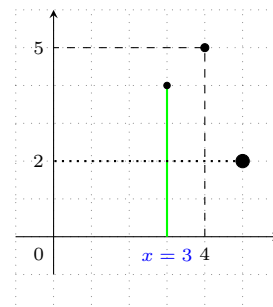

Specifying the option <x-shift,y-shift> with \tzprojx(*) and \tzprojy(*) moves the projection point and text accordingly.

```

% \tzprojx(*), \tzprojy(*): shift
\begin{tikzpicture}[scale=.5,font=\scriptsize]
\tzhelplines(-1,-2)(6,6)
\tzshoworigin
\tzaxes(-1,-1)(6,6)
\tzaxes[blue]<2,1>(-1,-1)(6,6)
\tzprojx*[green,thick,solid]<2,1>(3,4){$x=3$}[blue]
\tzprojy*[thick]<2,1>(5,2){2}(5pt)
\end{tikzpicture}

```

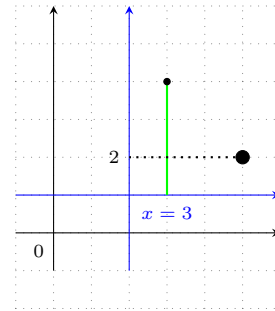

20.3 \tzprojs(*): Semicolon versions

\tzprojs accepts any number of coordinates and draws perpendicular lines onto each axis from the coordinates. The lines are dotted, by default. \tzprojs is a semicolon version of \tzproj, so a semicolon is needed to indicate when the coordinate iteration ends. Its repeating pattern is (<coor>){<x-text>}[<node opt>]{<y-text>}[<node opt>].

```

% syntax: minimum
\tzprojs(<coor>(<coor> ..repeated.. (<coor> ) ;
% syntax: medium
\tzprojs*(<coor>){<x-text>}[<node opt>]{<y-text>}[<node opt>]
..repeated.. (){}[]{}[]
% syntax: full
\tzprojs* [<opt>] <x-shift,y-shift>
(<coor>){<x-text>}[<node opt>]{<y-text>}[<node opt>]
..repeated.. (){}[]{}[] ; (<dot size>)
% defaults
*[dotted]<0,0>
(<m>){}[text height=1.25ex,text depth=.25ex,below]{}[left]
..repeated.. (){}[]{}[] ; (2.4pt)

```

\tzprojs* additionally prints \tzdots* of the 2.4pt (by default) on the coordinates. The first option [<opt>] does not control the node dots.

```

% \tzprojs(*): adding text
\begin{tikzpicture}[scale=.5]
\tzhelplines(8,6)
\tzaxes(8,6)
\tzcoors(30:7)(A)(50:6)(B);
\tzprojs*[dashed,text=blue]
(2,3){$x$}{$y$}
(A){$a_1$}{$a_2$}
(B){$x^*$}[green]{$y^*$}[red];
\end{tikzpicture}

```

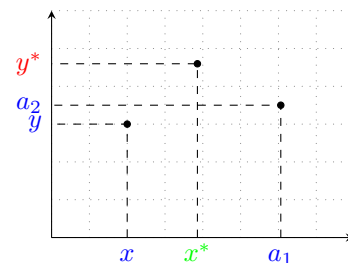

You can move the projection points and text accordingly, using the option <x-shift,y-shift> before the first coordinate. The empty shift option <> is not allowed. You can also change the dot size with the last option (<dot size>) after the semicolon, as in \tzproj(*).

```

% \tzprojs(*): shift and dot size
\begin{tikzpicture}[scale=.5]
\tzhelplines(8,6)
\tzaxes(8,6)
\tzaxes[blue]<1,1>(8,6)
\tzcoors(30:7)(A)(50:6)(B);
\tzprojs*[dashed,text=blue]<1,1>          %%
    (2,3){$x$}{$y$}
    (A){$a_1$}{$a_2$}
    (B){$x^*$}[green]{$y^*$}[red];(4pt) %%
\end{tikzpicture}

```

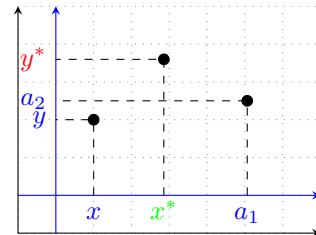

20.4 \tzprojsx(*) and \tzprojsy(*): Semicolon versions

\tzprojsx is a semicolon versions of \tzprojx. It draws dotted lines, which are perpendicular to the x axis from the specified coordinates, by default.

\tzprojsx* additionally prints \tzdots* of the size 2.4pt, by default.

```

% syntax:
\tzprojsx* [<opt>] <x-shift,y-shift>
    (<coor>){<x-text>} [<node opt>] ..repeated.. (){}[]; (<dot size>)
% defaults
* [] <0,0> (<m>){} [text height=1.25ex,text depth=.25ex,below]
    ..repeated.. (){}[]; (2.4pt)

```

\tzprojsy and \tzprojsy* work similarly as \tzprojsx and \tzprojsx* do but to the y axis.

```

% syntax:
\tzprojsy* [<opt>] <x-shift,y-shift>
    (<coor>){<y-text>} [<node opt>] ..repeated.. (){}[]; (<dot size>)
% defaults
[] <0,0> (<m>){} [left] ..repeated.. (){}[]; (2.4pt)

```

```

% \tzprojsx(*), \tzprojsy(*)
\begin{tikzpicture}[scale=.5,font=\scriptsize]
\tzhelplines(-1,-2)(6,6)
\tzshoworigin
\tzaxes(-1,-1)(6,6)
\tzprojsx*[thick]
    (4,5){4}
    (3,4){$x=3$}[blue]
    (5,2){2};(5pt)
\end{tikzpicture}

```

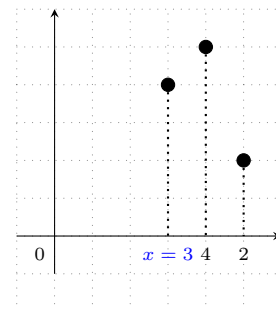

Specifying the option <x-shift,y-shift> moves the projection points and text accordingly.

```

% \tzprojx(*), \tzprojsy(*): shift
\begin{tikzpicture}[scale=.5,font=\scriptsize]
\tzhelplines(-1,-2)(6,6)
\tzshoworigin
\tzaxes(-1,-1)(6,6)
\tzaxes[blue]<2,1>(-1,-1)(6,6)
\tzprojx*[red,solid]<2,1>
(3,4){$x=3$}[blue]
(5,2){2};
\end{tikzpicture}

```

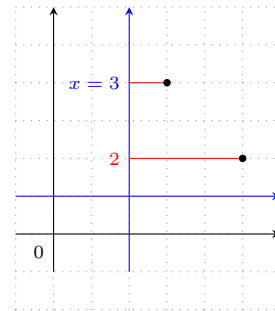

21 Plot Functions

21.1 \tzfn and \tzfn': Plot functions and inverse functions

21.1.1 \tzfn

\tzfn plots a function of x .

```

% syntax: minimum
\tzfn{<fn of \x>[<domain>]
% syntax: medium
\tzfn{<fn of \x>[<domain>]{<text>}[<pos>]
% syntax: full
\tzfn[<opt>]<shift coor>"<path name>"
    {<fn of \x>[<domain>]{<text>}[<node opt>]<code.append>
% [<domain>] should be of the form [<from num:to num>]
% defaults
[samples=201]<>"{<m>}[<m>]{ } [ ] <>

```

\tzfn takes two mandatory arguments: {<fn of x >} and [<domain>]. The domain should be of the form [<from num:to num>], like [1:5].

```

\tzfn{.5*(\x)^2-1}[1:5] % works like:
\draw [samples=201,domain=1:5] plot (\x,{.5*(\x)^2-1});

```

```

% \tzfn : simple example
\begin{tikzpicture}[scale=.5]
\tzhelplines(-2,-2)(5,5)
\tzaxes*(-2,-2)(5,5)
\tzfn{.5*(\x)^2-1}[0:3.5]
\end{tikzpicture}

```

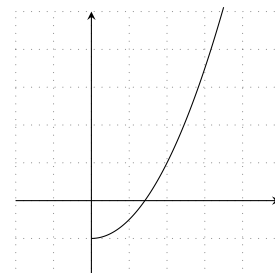

21.1.2 Inverse functions: \tzfn'

The *swap version* \tzfn' draws the *inverse function* of \tzfn.

```

\tzfn' {.5*(\x)^2-1}[1:5] % works like:
\draw [samples=201,domain=1:5] plot ({.5*(\x)^2-1},\x);

```



```

% \tzfn' : inverse function (with text)
\begin{tikzpicture}[scale=.5]
\tzhelplines(-2,-2)(5,5)
\tzaxes*(-2,-2)(5,5)
\tzfn{.5*(\x)^2-1}[0:3.5]
\tzfn'[red]{.5*(\x)^2-1}[0:3.5]{inversed}[r] %%
\end{tikzpicture}

```

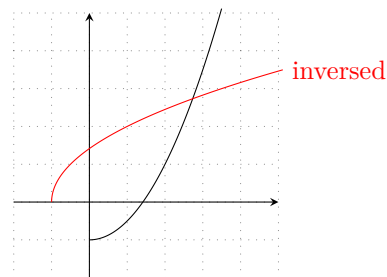

You can add text at the end of the graph, by specifying `{<text>}` and `[<node opt>]` immediately after the domain.

```

% \tzfn(')
\begin{tikzpicture}[scale=.5]
\tzhelplines(8,8)
\tzaxes(8,8){$Q$}{$P$}
\tzfn{5-5/7*\x}[0:7]{demand}[a=5mm]
\tzfn'[blue]{5-5/7*\x}[0:7]
      {inverse\\demand}[r=5mm,align=center]
\tzticks{5,7}{5,7}
\end{tikzpicture}

```

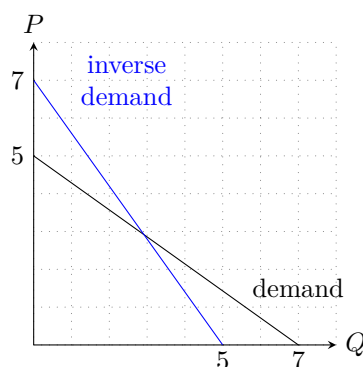

21.1.3 Define and name functions

To use `\tzfn` you need to express a function as a function of `\x`.

```

% \tzfn
\begin{tikzpicture}[scale=.5]
\tzhelplines(8,8)
\tzaxes(8,8)
\def\Dx{7-\x}      % define
\tzfn{\Dx}[0:7]{$D$}[ar]
\tzfn{1+\x}[0:7]{$S$}[blue,r]
\end{tikzpicture}

```

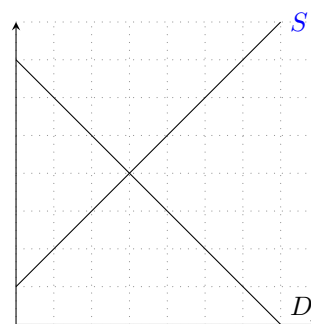

You can also use the predefined functions of TikZ such as `sin`, `cos`, `ln`, `log10`, `log2`, `exp`, `sqrt`, and so on. (See TikZ manual.)

```

% \tzfn
\begin{tikzpicture}[scale=.5]
\tzhelplines(-2,-2)(8,6)
\tzaxes*(-2,-2)(8,6)
\def\Fx{sin(\x r)+3}
\def\Gx{exp(\x)}
\def\Hx{ln(\x)}
\tzfn\Fx[-2:2*pi]{$\sin\,x+3$}[blue,r]
\tzfn[blue]\Gx[-2:2]{$e^x$}[red,r]
\tzfn[dashed]\Hx[.2:7]{$\ln\,x$}[r]
\end{tikzpicture}

```

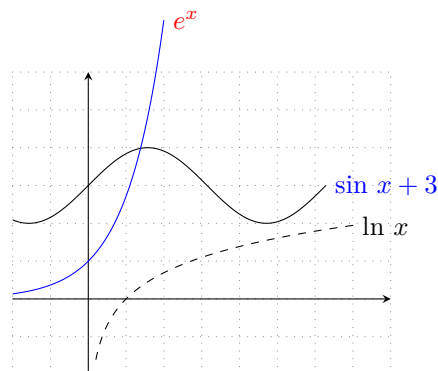

21.1.4 Name paths: name path

You can name the path of `\tzfn` by specifying the option "`<path name>`" *immediately before* the mandatory argument `{<fn of \x>}`. You can use the path names to find intersection points.

```
\tzfn"mypath"\Fx[1:5] % works like:
\draw [samples=201,,domain=1:5,name path=mypath] plot (\x,{\Fx});
```

Remark: Advantage of defining functions:

Suppose that the function's expression `<fn of \x>` consists *only of a macro name*, say, `\Fx`. Then

- The macro name `Fx` (*without the backslash*) is *automatically assigned* to `<path name>`, unless you give another name.
- That is, `\tzfn\Fx` is equivalent to `\tzfn"Fx"\Fx`. (*You don't need to type the same thing twice.*)

```
\tzfn\Fx[1:5] % works like:
\draw [samples=201,domain=1:5,name path=Fx] plot (\x,{\Fx});
```

```
% \tzfn: name path: intersection point
\begin{tikzpicture}[scale=.5]
\tzhelplines(8,8)
\tzaxes(8,8)
\def\Dx{7-\x}
\def\Sx{1+\x}
\tzfn"Dx"\Dx[0:7]{$D$}[ar] % name path = Dx
\tzfn \Sx[0:7]{$S$}[blue,r] % name path = Sx
\tzXpoint*\Dx*\Sx(E){E} % intersection
\end{tikzpicture}
```

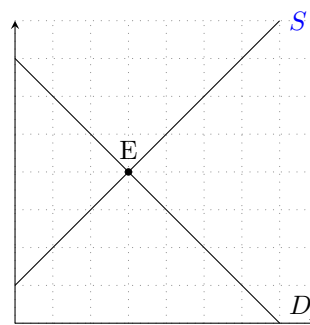

21.1.5 Move graphs: shift

You can move the graph of `\tzfn` by specifying the option `<shift coor>` *before* the mandatory argument `{<fn of \x>}` or *immediately before* the option "`<path name>`", if it exists. The *empty* shift option `<>` is *not allowed*.

```
% \tzfn: shift
\begin{tikzpicture}[scale=.6]
\tzhelplines(8,8)
\def\Dx{7-\x}
\def\Sx{1+\x}
\tzfn \Dx[0:7]{$D$}[right] % name path = Dx
\tzfn"supply"\Sx[0:7]{$S$}[right] % name path = supply
\tzXpoint*\Dx*\supply(E){E$}
\tzfn[dashed]<1,1>"demandA"\Dx[0:7]{$D'$}[r]
\tzfn[dashed]<1,-1>"supplyA"\Sx[0:7]{$S'$}[r]
\tzXpoint*\demandA*\supplyA(E1){E'$}
\end{tikzpicture}
```

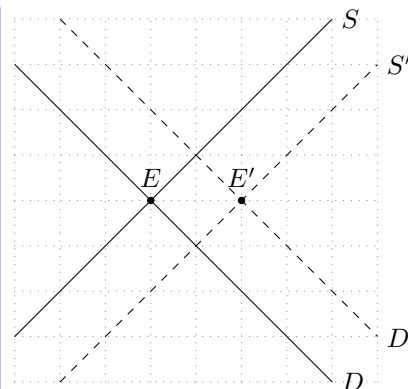

21.1.6 Extend paths: `<code.append>`, `\tzfnAtBegin`, `\tzfnAtEnd`

`<code.append>` You can extend the path of `\tzfn`, by writing TikZ code in the *last optional argument* `<code.append>`. Internally it adds the TikZ code to the path *after* the options `{<text>}` and `[<node opt>]`.

```
% \tzfn: <code.append>
\begin{tikzpicture}[scale=.5]
\tzhelplines(-2,-2)(8,6)
\tzaxes*(-2,-2)(8,6)
\def\Fx{sin(\x r)+3}
\tzfn[->]\Fx[-2:2*pi]{\sin\x+3}[blue,r]
    < to [bend right] ++(2,-2) node [b] {End!} >
\end{tikzpicture}
```

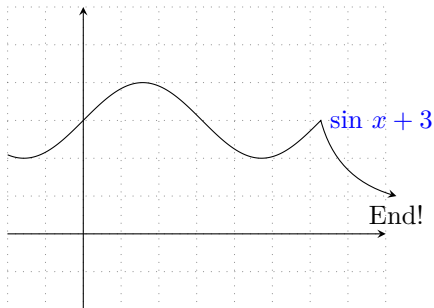

`\tzfnAtEnd` You can also extend the path of `\tzfn` at the end using `\tzfnAtEnd`. Internally it adds TikZ code immediately *before* the options `{<text>}` and `[<node opt>]`. But you have to use `\tzfnAtEnd` (immediately) *before each* `\tzfn`.

```
% \tzfnAtEnd (before \tzfn)
\begin{tikzpicture}[scale=.5]
\tzhelplines(-2,-2)(8,6)
\tzaxes*(-2,-2)(8,6)
\def\Fx{sin(\x r)+3}
\tzfnAtEnd{to [bend right] ++(2,-2) node [b] {End!}}
\tzfn[->]\Fx[-2:2*pi]{\sin\x+3}[blue,r]
\end{tikzpicture}
```

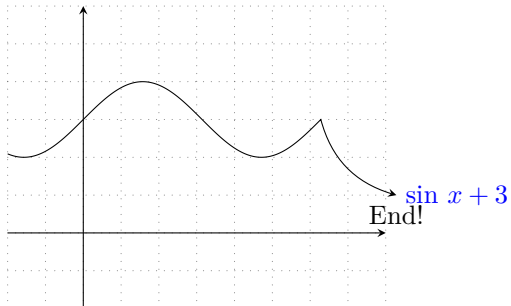

Specifying the option `<code.append>` extends the path after `\tzfnEnd` if it exists.

```
% \tzfnAtEnd (before \tzfn)
\begin{tikzpicture}[scale=.5]
\tzhelplines(-2,-2)(8,6)
\tzaxes*(-2,-2)(8,6)
\def\Fx{sin(\x r)+3}
\tzfnAtEnd{to [bend right] ++(2,-2) node [b] {End!}}
\tzfn[->]\Fx[-2:2*pi]{\sin\x+3}[blue,r]
    < arc (0:90:4cm) node [draw,red,left] {Here!!} >
\end{tikzpicture}
```

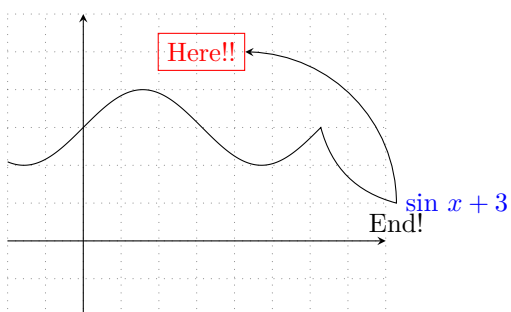

`\tzfnAtBegin` You can use `\tzfnAtBegin` (immediately) *before each* `\tzfn` to insert TikZ code at the beginning of the path of `\tzfn`.

```
% \tzfnAtBegin (before \tzfn)
\begin{tikzpicture}[scale=.5]
\tzhelplines(-2,-2)(8,6)
\tzaxes*(-2,-2)(8,6)
\def\Fx{sin(\x r)+3}
\tzfnAtBegin{ (1,1) -| }
\tzfn[->]\Fx[-2:2*pi]{\sin\x+3}[blue,r]
\end{tikzpicture}
```

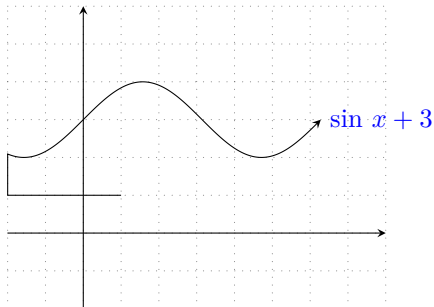

Remark:

- `\tzfn` is based on the `plot` operation of `TikZ`.
- Appending `TikZ` code at the beginning of `\tzfn` may cause a problem when you use some operations (such as `to` or `-|` or `|-`) that expect a coordinate to link.
- In the version 2 of the `tzplot` package, this issue is internally taken care of by using (`current subpath start`), which is a special coordinate pre-defined in `TikZ`. (See `TikZ` manual for more details.)

21.2 `\tzfnofy` and `\tzfnofy'`: Functions of variable y

`\tzfnofy` plots a function of y . Define a function with the (predefined) variable y .

`\tzfnofy` works just like `\tzfn` but as a function of y .

```
% syntax: minimum
\tzfnofy{<fn of \y>}[<domain>]
% syntax: medium
\tzfnofy{<fn of \y>}[<domain>]{<text>}[<pos>]
% syntax: full
\tzfnofy[<opt>]<shift coor>"<path name>"
    {<fn of \y>}[<domain>]{<text>}[<node opt>]<code.append>
% [<domain>] should be of the form [<from num>:<to num>]
% defaults
[samples=201]<>"{<m>}[<m>]{[]}<>
```

```
\tzfnofy{2*\y+1}[1:5] % works like:
\draw [samples=201,domain=1:5,variable=\y] plot ({2*\y+1},\y);
```

The *swap version* `\tzfnofy'` plots the *inverse function* of `\tzfnofy`.

```
\tzfnofy'{2*\y+1}[1:5] % works like:
\draw [samples=201,domain=1:5,variable=\y] plot (\y,{2*\y+1});
```

```
% \tzfnofy('): variable = \y
\begin{tikzpicture}[scale=.5]
\tzhelplines(8,8)
\tzaxes(8,8){$x$}{$y$}
\tzfnofy{5-5/7*\y}[0:7]{$f(y)$}[r=5mm]
\tzfnofy'[blue]{5-5/7*\y}[0:7]
    {$f^{-1}(y)$}[a=5mm,align=center]
\tzticks{5,7}{5,7}
\end{tikzpicture}
```

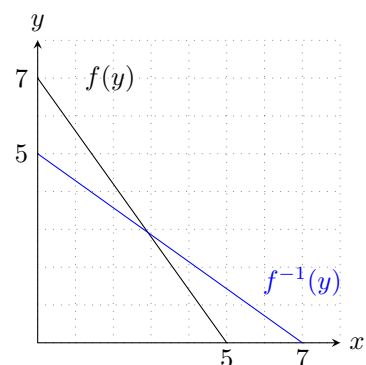

```

% \tzfnofy: shift: intersections
\begin{tikzpicture}[scale=.6]
\tzhelplines(8,8)
\def\Fy{7-\y}
\def\Gy{1+\y}
\tzfnofy\Fy[0:7]{f(y)}[right] % name path = Fy
\tzfnofy\Gy[0:7]{g(y)}[right] % name path = Gy
\tzXpoint*\Fy*\Gy(E){$E$}
\tzfnofy[dashed]<1,1>"Fyy"\Fy[0:7]{shifted}[r]
\tzfnofy[dashed]<1,-1>"Gyy"\Gy[0:7]{shifted}[r]
\tzXpoint*\Fyy*\Gyy(E1){$E'$}
\end{tikzpicture}

```

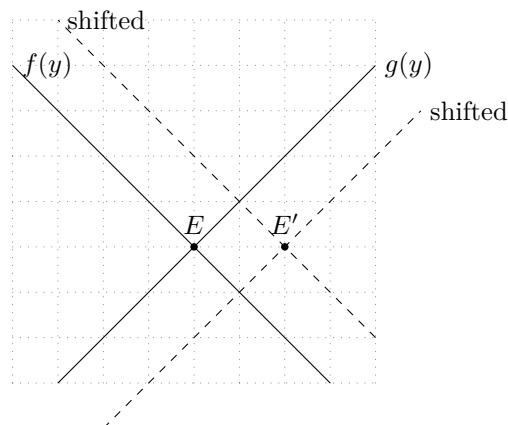

You can also extend the path of `\tzfnofy` using the option `<code.append>` or the macros `\tzfnofyAtBegin` and `\tzfnofyAtEnd`.

```

% \tzfnofy: shift: intersections
\begin{tikzpicture}[scale=.5]
\tzhelplines(8,8)
\def\Fy{7-\y}
\tzfnofyAtBegin{(6,3) node [a] {Start} to[bend left]}
\tzfnofyAtEnd{ -| ++(3,-1) }
\tzfnofy[->]\Fy[1:7]
< to[bend right] ++(3,2) node [draw,r] {End!} >
\end{tikzpicture}

```

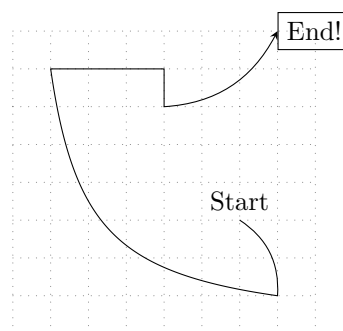

21.3 Horizontal lines

21.3.1 \tzhfnat

`\tzhfnat` draws a horizontal line at a specified value of y .

```

% syntax: minimal
\tzhfnat{<y-val>}[<domain>]
% syntax: full
\tzhfnat[<opt>]<shift coor>"<path name>"
    {<y-val>}[<domain>]{<text>}[<node opt>]<code.append>
% defaults
[]<>"{<m>}[west:east (of current bounding box)]{[]}<>

```

`\tzhfnat` accepts only one mandatory argument `{<y-val>}`. The domain is optional and should be of the form `[<from num>:to num>]`. The default domain is from left to right of the current bounding box.

Remark: Internally, the default domain of `\tzhfnat` depends on the current bounding box.

- Each `\tzhfnat` may draw a line with a (slightly) different length.
- If an appropriate current bounding box is not formed before `\tzhfnat` is executed, you will probably get an unexpected result.
- In that case, you can fix a bounding box in the beginning of the `tikzpicture` environment using macros such as `\tzbbox`, `\tzhelplines*`, `\tzaxes*`, or TikZ's `\useasboundingbox`.

```

% \tzhfnat
\begin{tikzpicture}
\tzhelplines(4,3)
\tzhfnat[blue,thick]{0}
\tzhfnat[red,thick]{1}[1:3]{line A}[r]
\tzhfnat[blue]{2}{line B}[r]
\tzhfnat[red]{3}[0:3]{line C}[draw=blue,red,r]
\end{tikzpicture}

```

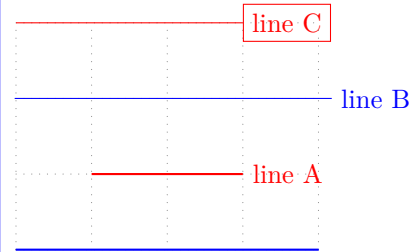

You can name the path of `\tzhfnat` by the option "`<path name>`". You can move the line by the option `<shift coor>`. You can also extend the path from the end of the line by writing TikZ code in the last optional argument `<code.append>`.

```

% \tzhfnat: shift, <code.append>
\begin{tikzpicture}
\tzhelplines*(4,4) % bounding box
\tzfn"XX"{\x}[0:4]
\tzhfnat[blue,thick]{0}
\tzhfnat[red,thick]<-.5,.5>"AA"{1}[1:3]{line A'}[r]
\tzXpoint*{AA}{XX}
\tzhfnat[blue,->]{2}{line B}[r]
    < arc (0:120:1.5) node [b,draw] {End!} >
\end{tikzpicture}

```

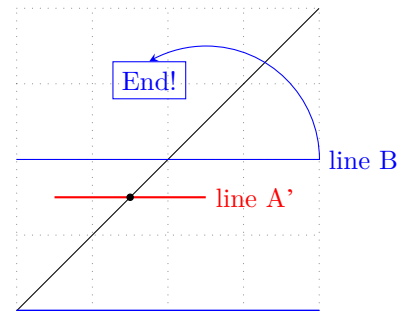

You can also use `\tzhfnatAtBegin` and `\tzhfnatAtEnd` to extend the path of `\tzhfnat` at the beginning and at the end. Specifying the option `<code.append>` extends the path after `\tzhfnatAtEnd` if it exists. (See other examples of using `\tz<...>AtBegin` and `\tz<...>AtEnd`.)

21.3.2 `\tzhfn`

`\tzhfn` accepts a coordinate as a mandatory argument and draws a horizontal line at the y value of the coordinate. For example, `\tzhfn(<x>,3)`, ignoring `<x>`, is equivalent to `\tzhfnat{3}`.

Everything else is the same as in `\tzhfnat`.

```

% syntax: minimal
\tzhfn(<coor>)[<domain>]
% syntax: full
\tzhfn[<opt>]<shift coor>"<path name>"
    (<coor>)[<domain>]{<text>}[<node opt>]<code.append>
% defaults
[]<>"<m>"[west:east (of current bounding box)]{}[]<>

```

```

% \tzhfn: shift, <code.append>
\begin{tikzpicture}
\tzhelplines*(4,4) % bounding box
\tzcoors(0,1)(A)(0,2)(B);
\tzfn"XX"{\x}[0:4]
\tzhfn[blue,thick](5,0) % x=5 ignored
\tzhfn[red,thick]<-.5,.5>"AA"(A)[1:3]{line A'}[r]
\tzXpoint*{AA}{XX}
\tzhfn[blue,->](B){line B}[r]
    < arc (0:120:1.5) node [b,draw] {End!} >
\end{tikzpicture}

```

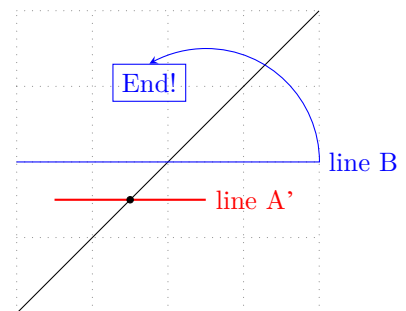

You can also use `\tzhfnAtBegin` and `\tzhfnAtEnd` to extend the path of `\tzhfn` at the beginning and at the end. Specifying the option `<code.append>` extends the path after `\tzhfnAtEnd` if it exists. (See other examples of using `\tz<...>AtBegin` and `\tz<...>AtEnd`.)

21.4 Vertical lines

21.4.1 `\tzvfnat`

`\tzvfnat` draws a vertical line at a specified value of x .

```
% syntax: minimal
\tzvfnat{<x-val>}[<domain>]
% syntax: full
\tzvfnat[<opt>]<shift coor>"<path name>"
    {<x-val>}[<domain>]{<text>}[<node opt>]<code.append>
% defaults
[]<>"[<m>][south:north (of current bounding box)]{ }[]<>
```

`\tzvfnat` accepts only one mandatory argument `{<x-val>}`. The domain is optional and should be of the form `[<from num>:to num>]`. The default domain is from bottom to top of the current bounding box.

```
% \tzvfnat
\begin{tikzpicture}
\tzhelplines(4,4)
\tzvfnat[blue,thick]{0}
\tzvfnat[red,thick]{1}[1:3]{line A}[a]
\tzvfnat[blue]{2}{line B}[a]
\tzvfnat[red]{3}[0:3]{line C}[draw=blue,red,a]
\end{tikzpicture}
```

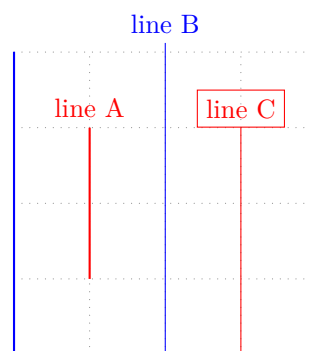

You can name the path of `\tzvfnat` by the option `"<path name>"`. You can move the line by the option `<shift coor>`. You can also extend the path from the end of the line by writing `TikZ` code in the last optional argument `<code.append>`.

```
% \tzvfnat: shift, <code.append>
\begin{tikzpicture}
\tzhelplines*(4,4) % bounding box
\tzfn"XX"{\x}[0:4]
\tzvfnat[blue,thick]{0}
\tzvfnat[red,thick]<.5,-.5>"AA"{1}[1:3]{line A'}[a]
\tzXpoint*{AA}{XX}
\tzvfnat[blue,->]{2}{line B}[a]
    < arc (90:-30:1.5) node [b,draw] {End!} >
\end{tikzpicture}
```

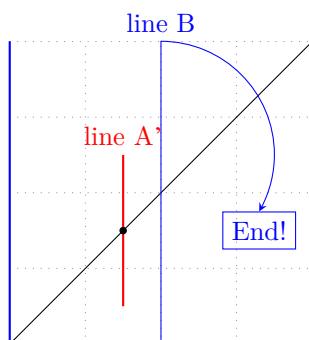

In the previous example, `\tzhelplines*` is used to fix a bounding box. (See Section 7.2 on page 40, for more details.)

You can also use `\tzvfnatAtBegin` and `\tzvfnatAtEnd` to extend the path of `\tzvfnat` at the beginning and at the end. Specifying the option `<code.append>` extends the path after `\tzvfnatAtEnd` if it exists. (See other examples of using `\tz<...>AtBegin` and `\tz<...>AtEnd`.)

21.4.2 \tzvfn

\tzvfn accepts a coordinate as a mandatory argument and draws a horizontal line at the x value of the coordinate. For example, \tzvfn(3,<y>), ignoring <y>, is equivalent to \tzvfnat{3}.

Everything else is the same as in \tzvfnat.

```
% syntax: minimal
\tzvfn(<coor>)[<domain>]
% syntax: full
\tzvfn[<opt>]<shift coor>"<path name>"
    (<coor>)[<domain>]{<text>}[<node opt>]<code.append>
% defaults
[]<>"(<m>)[south:north (of current bounding box)]{}[]<>
```

```
% \tzvfn: shift, <code.append>
\begin{tikzpicture}
\tzhelplines*(4,4) % bounding box
\tzcoors(1,0)(A)(2,0)(B);
\tzfn"XX"{\x}[0:4]
\tzvfn[blue,thick](0,5) % y=5 ignored
\tzvfn[red,thick]<.5,-.5>"AA"(A)[1:3]{line A'}[a]
\tzXpoint*{AA}{XX}
\tzvfn[blue,->](B){line B}[a]
    < arc (90:-30:1.5) node [b,draw] {End!} >
\end{tikzpicture}
```

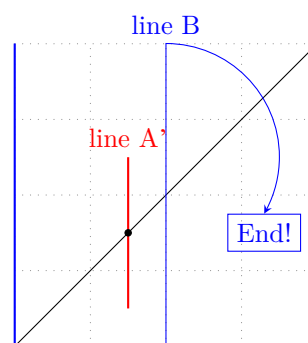

You can also use \tzvfnAtBegin and \tzvfnAtEnd to extend the path of \tzvfn at the beginning and at the end. Specifying the option <code.append> extends the path after \tzvfnAtEnd if it exists. (See other examples of using \tz<...>AtBegin and \tz<...>AtEnd.)

22 Plot Linear Functions

22.1 \tzLFn: Plot linear functions

22.1.1 \tzLFn and \tzLFn'

Knowing two coordinates or one coordinate with a slope, you can draw a linear function with the macro \tzLFn, *without writing the explicit definition of a linear function*.

- \tzLFn(<coor1>)(<coor2>) is prepared for when you know two coordinates on a line.
 - If you provide two points (x_1, y_1) and (x_2, y_2) , \tzLFnofy(x1,x2)(y1,y2) draws the graph of $f(x) = \frac{y_2 - y_1}{x_2 - x_1}(x - x_1) + y_1$.
- \tzLFn(<coor1>){<slope>} is used when you know one coordinate and the slope of a line.
- If you specify all the three arguments (<coor1>)(<coor2>){<slope>}, then the slope is ignored.

For example, \tzLFn(1,1)(2,3)[0:4] draws a line passing through two points: (1,1) and (2,3), over $0 \leq x \leq 4$. \tzLFn(1,1){.5}[0:4] draws a line passing through a point (1,1) with a slope .5, over $0 \leq x \leq 4$.

\tzLFn accepts two mandatory arguments: (<coor1>) and [<domain>].

- The *domain* should be of the form [<from num>:to num>].
- If just one coordinate is specified without a slope, the slope is regarded as 1, by default.

```
% syntax: minimum
\tzLFn(<coor1>)(<coor2>)[<domain>] % two coordinates
\tzLFn(<coor1>){<slope>}[<domain>] % one coordinate and slope
```



```

% syntax: full
\tzLFn[<opt>]<shift coor>"<path name>"
    (<coor1>)<coor2>){<slope>}[<domain>]{<text>}[<node opt>]<code.append>
% defaults
[]<>"(<m>){1}{<m>}{ }[]<>

```

You can add text at the end of the line of `\tzLFn` by the options `{<text>}` and `[<node opt>]`. You can also name the path of `\tzLFn` by specifying the option `"<path name>"` *immediately before* the mandatory coordinate.

```

% \tzLFn: two coordinates
\begin{tikzpicture}
\tzhelplines(4,3)
\tzcoors*(1,1)(A)(1,2)(B)(3,1)(C);
\tzLFn[blue]"Gx"(B)(C)[0:4]{$g(x)}[r]
\end{tikzpicture}

```

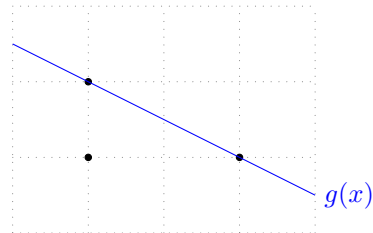

```

% \tzLFn: one coordinate and slope
\begin{tikzpicture}
\tzhelplines(4,3)
\tzcoors*(1,1)(A)(1,2)(B)(3,1)(C);
\tzLFn[red]"Fx"(A){.5}[0:4]{$f(x)}[a]
\end{tikzpicture}

```

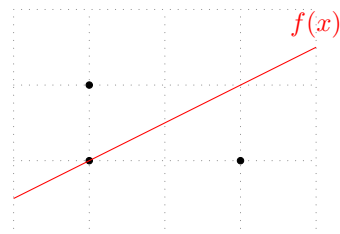

Remark: If you inadvertently try an *infinite slope*, you will get an *error message*.

Inverse function The *swap version* `\tzLFn'` draws the *inverse function* of `\tzLFn`.

```

% \tzLFn' : inverse function : intersection
\begin{tikzpicture}[scale=.8]
\tzhelplines(4,4)
\tzcoors*(1,1)(A)(1,2)(B)(3,1)(C);
\tzLFn'[red]"Fx"(A){.5}[0:4]{$f(x)}[a]
\tzLFn'[blue]"Gx"(B)(C)[0:4]{$g(x)}[r]
\tzXpoint*[fill=none]{Fx}{Gx}(E){$E$}(3pt)
\end{tikzpicture}

```

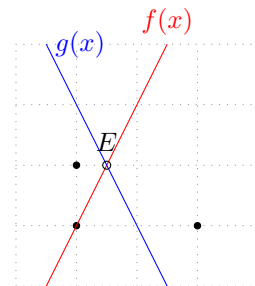

You can move the line of `\tzLFn` by specifying the option `<shift coor>` immediately before the option `"<path name>"`. (The *empty* shift option `<>` is *not allowed*.) You can also extend the path of `\tzLFn` by writing TikZ code in the last optional argument `<code.append>`.

```

% \tzLFn: shift, extending path
\begin{tikzpicture}[scale=.8]
\tzhelplines(4,4)
\tzcoors*(1,1)(A)(1,2)(B)(3,1)(C);
\tzLFn[blue]"Gx"(B)(C)[0:4]{$g(x)}[r]
\tzLFn[dashed,red,-><1,1>"Gx"(B)(C)[0:4]{$g(x)}[r]
    < arc (0:140:2) node [below] {End!} >
\end{tikzpicture}

```

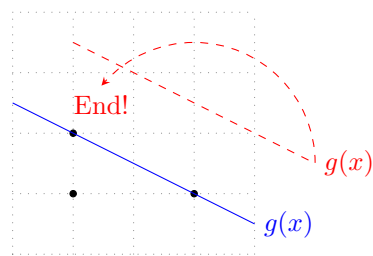

`\tzLFnAtBegin` and `\tzLFnAtEnd` are available to extend a path of `\tzLFn` at the beginning and the end, respectively. Specifying the option `<code.append>` extends the path after `\tzLFnAtEnd`, if it exist.

```

% \tzLFnAtBegin and \tzLFnAtEnd
\begin{tikzpicture}[scale=.8]
\tzhelplines*(4,4)
\tzcoors*(1,1)(A)(1,2)(B)(3,1)(C);
\tzLFn[blue]"Gx"(B)(C)[0:4]{$g(x)$}[r]
\tzLFnAtBegin{(1,0) to [bend left] }
\tzLFnAtEnd{ arc (0:140:2) }
\tzLFn[dashed,red,-><1,1>"Gx"(B)(C)[0:4]{$g(x)$}[r]
\end{tikzpicture}

```

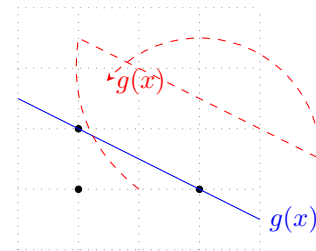

22.1.2 \tzLFnofy and \tzLFnofy'

\tzLFnofy draws a line as a function of y . \tzLFnofy works just like \tzLFn but for the variable y . If you provide two points (x_1, y_1) and (x_2, y_2) , \tzLFnofy(x_1, x_2)(y_1, y_2) draws the graph of $f(y) = \frac{x_2 - x_1}{y_2 - y_1}(y - y_1) + x_1$.

Everything else is the same as \tzLFn.

```

% syntax: minimum
\tzLFnofy(<coor1>)(<coor2>)[<domain>]
\tzLFnofy(<coor1>){<slope>}[<domain>]
% syntax: full
\tzLFnofy[<opt>]<shift coor>"<path name>"
    (<coor1>)(<coor2>){<slope>}[<domain>]{<text>}[<node opt>]<code.append>
% defaults
[]<>"(<m>){1}[<m>]{}[]<>

```

```

% \tzLFnofy
\begin{tikzpicture}[scale=.8]
\tzhelplines(4,4)
\tzcoors*(1,1)(A)(1,2)(B)(3,1)(C);
\tzLFnofy[red]"Fx"(A){.5}[0:4]{$f(y)$}[a]
\tzLFnofy[blue]"Gx"(B)(C)[.5:2.5]{$g(y)$}[a]
\tzXpoint*[fill=none]{Fx}{Gx}(E){$E$}(3pt)
\end{tikzpicture}

```

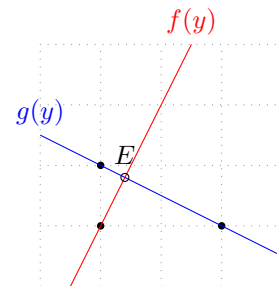

Remark: If you inadvertently try an *infinite slope*, you will get an *error message*.

Inverse function The *swap version* \tzLFnofy' draws the *inverse function* of \tzLFnofy.

```

% \tzLFnofy'
\begin{tikzpicture}[scale=.8]
\tzhelplines(4,4)
\tzcoors*(1,1)(A)(1,2)(B)(3,1)(C);
\tzLFnofy'[red]"Fx"(A){.5}[0:4]{$f(y)$}[a]
\tzLFnofy'[blue]"Gx"(B)(C)[.5:2.5]{$g(y)$}[r]
\tzXpoint*[fill=none]{Fx}{Gx}(E){$E$}(3pt)
\end{tikzpicture}

```

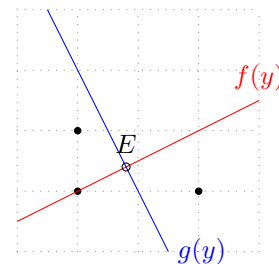

You can use \tzLFnofyAtBegin and \tzLFnofyAtEnd to extend the path of \tzLFnofy at the beginning and at the end. Specifying the optional argument `<code.append>` extends the path after \tzLFnofyAtEnd if it exists. (See other examples of using \tz<...>AtBegin and \tz<...>AtEnd.)

22.2 \tzdefLFn

\tzdefLFn simply defines a linear function $ax + b$ and saves it to a macro. You can use \tzdefLFn together with \tzfn to graph a linear function, *without writing an explicit definition* of a linear function. (Of course, you can directly use \tzLFn.)

```
% syntax
\tzdefLFn{<fn csname>}<coor1><coor2><slope>
% defaults
{<m>}<m>() {1}
```

If (<coor2>) is specified, <slope> is ignored. If (<coor2>) is missing <slope> is considered as the slope of the line (by default 1).

For example, \tzdefLFn{\Gx}(1,1){.5} defines as \Gx a linear function passing through the point (1, 2) with a slope .5. That is, it defines a function as $f(x) = .5(x - 1) + 1$. Knowing two coordinates, linear function \Gx passing through the two points can be defined, for example, by \tzdefLFn{\Gx}(1,2)(3,1). That is, it defines a function as $g(x) = \frac{1-2}{3-1}(x - 1) + 2$.

```
\tzdefLFn{\Fz}(1,2)(3,1) % works like
\def\Fz{-1/2*(\x-1)+2}
```

Remark: If you inadvertently try an *infinite slope*, you will get an *error message*.

```
% \tzdefLFn and \tzfn
\begin{tikzpicture}
\tzhelplines(4,4)
\tzaxes(4,4){\x}{\y}
\tzticks{1,2,3,4}{1,2,3,4}
\tzcoors*(1,1)(A){A}[-90](1,2)(B){B}(3,1)(C){C}[45];
\tzdefLFn\Fz(A){.5}
\tzdefLFn\Gz(B)(C)
\tzfn[red]\Fz[0:4]{f(x)}[r]
\tzfn[blue]\Gz[0:4]{g(x)}[r]
\end{tikzpicture}
```

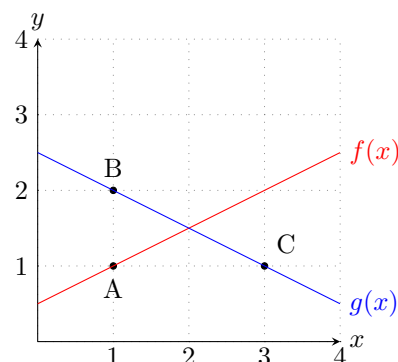

Remark: The swap version \tzfn' simply draws the graph of the inverse function of \tzfn. So \tzfn'(A)(B) and \tzfn'(A){.5} do not guarantee passing through the coordinate (A) or (B).

```
% \tzdefLFn and \tzfn'
\begin{tikzpicture}
\tzhelplines(4,4)
\tzaxes(4,4){\x}{\y}
\tzticks{1,2,3,4}{1,2,3,4}
\tzcoors*(1,1)(A){A}[-90](1,2)(B){B}(3,1)(C){C}[45];
\tzdefLFn\Fz(A){.5}
\tzdefLFn\Gz(B)(C)
\tzfn'[red]\Fz[0:4]{f(x)}[r]
\tzfn'[blue]\Gz[0:4]{g(x)}[r]
\end{tikzpicture}
```

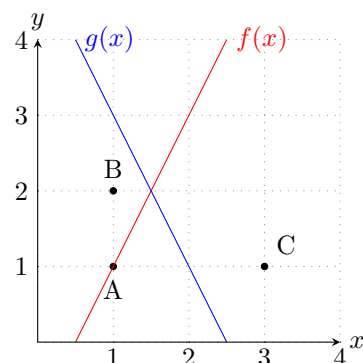

22.3 \tzdefLFnofy

\tzdefLFnofy defines a function of \y.

```

% syntax
\tzdefLFnofy{<fn csname>}{<coor1>}{<coor2>}{<slope>}
% defaults
{<m>}{<m>}{1}

```

If (<coor2>) is specified, {<slope>} is ignored. If (<coor2>) is missing <slope> is considered as the slope of the line (by default 1).

```

\tzdefLFnofy\Fy(1,1){.5} % works like
\def\Fy{.5*(\y-1)+1}

```

```

\tzdefLFnofy\Gy(1,2)(3,1) % works like
\def\Gy{-2*(\y-2)+1}

```

Remark: If you inadvertently try an *infinite slope*, you will get an *error message*.

You can use \tzdefLFnofy together with \tzFnofy to graph a linear function of y . (Of course, you can directly use \tzLFnofy.)

```

% \tzdefLFnofy and \tzLFnofy
\begin{tikzpicture}
\tzhelplines(4,4)
\tzaxes*(4,4){$x$}{$y$}
\tzticks{1,2,3,4}{1,2,3,4}
\tzcoors*(1,1)(A){A}[-90](1,2)(B){B}(3,1)(C){C}[45];
\tzdefLFnofy\Fy(A){.5}
\tzdefLFnofy\Gy(B)(C)
\tzfnofy[red]\Fy[0:4]{$f(y)$}[r]
\tzfnofy[blue]\Gy[0:4]{$g(y)$}[a]
\end{tikzpicture}

```

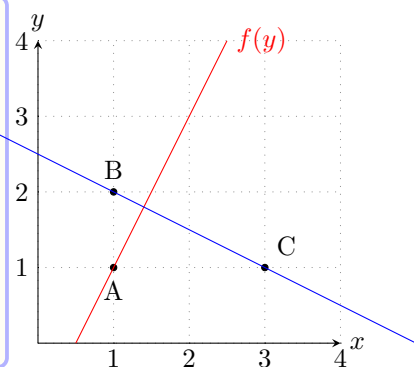

Remark: The swap version \tzfnofy' simply draws the graph of the inverse function of \tzfnofy. So \tzfnofy'(A)(B) and \tzfnofy'(A){.5} do not guarantee passing through the coordinate (A) or (B).

```

% \tzdefLFnofy and \tzLFnofy'
\begin{tikzpicture}
\tzhelplines(4,4)
\tzaxes*(4,4){$x$}{$y$}
\tzticks{1,2,3,4}{1,2,3,4}
\tzcoors*(1,1)(A){A}[-90](1,2)(B){B}(3,1)(C){C}[45];
\tzdefLFnofy\Fy(A){.5}
\tzdefLFnofy\Gy(B)(C)
\tzfnofy'[red]\Fy[0:4]{$f(y)$}[r]
\tzfnofy'[blue]\Gy[0:4]{$g(y)$}[r]
\end{tikzpicture}

```

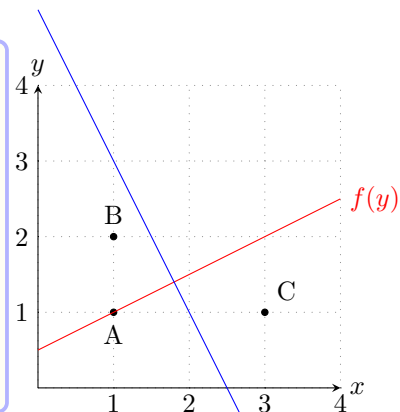

23 Some More Functions

23.1 `\tzpdfN(*)` and `\tzpdfZ`: Normal distributions

`\tzpdfN`, `\tzpdfN*` and `\tzpdfZ` are predefined functions to plot the *probability density function* (pdf) of a *normal distribution* $N(\mu, \sigma^2)$.

Normal distributions `\tzpdfN` accepts two mandatory arguments, `{<mean>}` μ and `{<variance>}` σ^2 , to define the pdf function:

$$\frac{1}{\sigma\sqrt{2\pi}} e^{-\frac{1}{2}\left(\frac{x-\mu}{\sigma}\right)^2}$$

`\tzpdfN*` uses a standard deviation σ instead of a variance.

With these predefined functions together with `\tzfn` you can plot the pdf of normal distributions.

```
% \tzpdfN, \tzpdfN*
\begin{tikzpicture}
  \rightarrow [xscale=0.5,yscale=5,font=\scriptsize]
  \tzhelplines [ystep=0.1] (-4,0) (6,.5)
  \tzaxes (-4,0) (6,.5)
  \tzticks {1,...,5} {0.1,0.2,0.3,0.4}
  \tzfn [blue] {\tzpdfN{0}{1.5}} [-4:4] % \tzpdfN
  \tzfn [red] {\tzpdfN*{2}{sqrt(1.5)}} [-2:6] % \tzpdfN*
\end{tikzpicture}
```

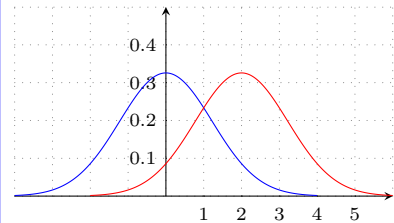

```
% \tzpdfN, \tzpdfN*
\begin{tikzpicture}[x=0.5cm,y=5cm,font=\scriptsize]
  \tzhelplines [step=.5cm] (-4,0) (6,.5)
  \tzaxes (-4,0) (6,.5)
  \tzticks {1,2,3} {0.1,0.2,0.3,0.4}
  \tzfn [blue] {\tzpdfN{0}{1.5}} [-4:4]
  \tzfn [red] {\tzpdfN*{2}{sqrt(1.5)}} [-2:6]
\end{tikzpicture}
```

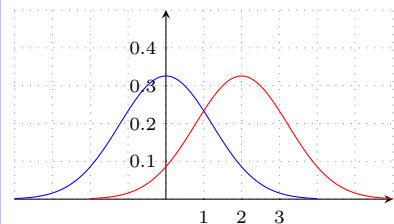

Remark: If `tikzpicture` is scaled when plotting the inverse function using `\tzfn'`, you may want to change the scale accordingly.

```
% \tzpdfN and \tzfn'
\begin{tikzpicture}[x=0.5cm,y=5cm,,font=\scriptsize]
  \tzhelplines [step=0.5cm] (-4,-.3) (6,.5)
  \tzaxes (-4,-.3) (6,.5)
  % scale change
  \begin{scope}[xscale={1/0.5*5},yscale={1/5*0.5}]
    \tzfn' [blue] {\tzpdfN{0}{1.5}} [-4:4]
    \tzfn' [red] {\tzpdfN*{2}{sqrt(1.5)}} [-2:6]
  \end{scope}
\end{tikzpicture}
```

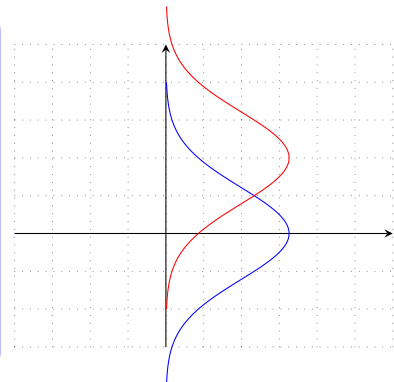

Standard normal distributions `\tzpdfZ` (with no arguments) represents the pdf of the *standard normal distribution*.

```

% \tzpdfZ: shift
\begin{tikzpicture}[x=0.5cm,y=5cm,font=\scriptsize]
\tzhelplines[step=0.5cm](-4,0)(6,.5)
\tzaxes(-4,0)(6,.5)
\tzticks{1,...,5}{0.1,0.2,0.3,0.4}
\tzfn[blue]{\tzpdfZ}[-3:3] % \tzpdfZ
\tzfn[red]<2,0>{\tzpdfZ}[-3:3] % shift
\tzfn[dashed]<3,.1>{\tzpdfZ}[-3:3] % shift
\end{tikzpicture}

```

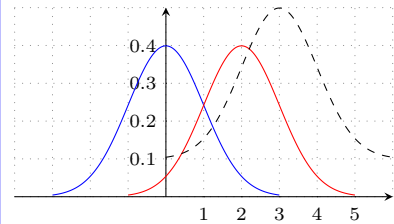

23.2 \tzfnarea(*): Fill under the graph

23.2.1 \tzfnarea(*)

\tzfnarea fills the area between the graph of a function and the x axis, with a color or pattern, on the behind layer by default. With \setztzfnarealayer, you can change the layer of \tzfnarea.

\tzfnarea accepts two mandatory arguments: {<fn of \x>} and [<domain>], like \tzfn.

```

% syntax: minimum
\tzfnarea{<fn of \x>}[<domain>]
% syntax: full
\tzfnarea[<opt>]{<fn of \x>}[<domain>]{<fill opacity>}<code.append>
% defaults
[] {<m>} [<m>] { .3 } <>

```

```

% \tzfnarea
\begin{tikzpicture}
\tzhelplines(0,-1)(4,2)
\tzaxes(0,-1)(4,2)
\def\Fx{.5*(\x-1)^2-1}
\tzfn[very thick]\Fx[0:3.5]
\tzfnarea[fill=red]\Fx[1:3] %
\end{tikzpicture}

```

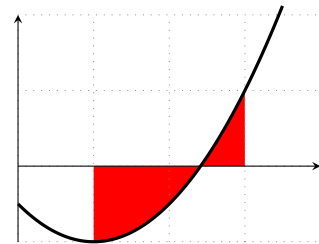

```

% \tzfnarea: layer: comparison
\begin{tikzpicture}
\tzhelplines(0,-1)(4,2)
\setztzfnarealayer{main} %%
\tzaxes(0,-1)(4,2)
\def\Fx{.5*(\x-1)^2-1}
\tzfn[very thick]\Fx[0:3.5]
\tzfnarea[fill=red]\Fx[1:3] %
\end{tikzpicture}

```

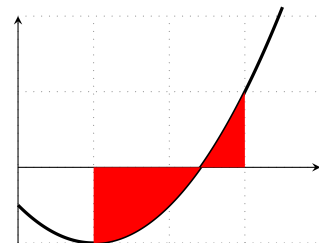

The starred version \tzfnarea* fills the area with fill=black!50 and fill opacity=.3, and text opacity=1, by default. The default values can be changed by \setztzfillcolor, \setztzfillopacity, and the option {<fill opacity>}.

```

% \tzfnarea*
\begin{tikzpicture}[x=0.5cm,y=5cm,font=\scriptsize]
\tzhelplines[step=.5cm](-4,-.1)(6,.5)
\tzaxes(-4,-.1)(6,.5)
\tzfn[blue]{\tzpdfZ}[-3:3]
\tzfnarea*{\tzpdfZ}[-3:1]
\tzfn"AA"{\tzpdfN21}[-1:5]
\tzfnarea*[pattern=north east lines]{\tzpdfN21}[1:3]
\end{tikzpicture}

```

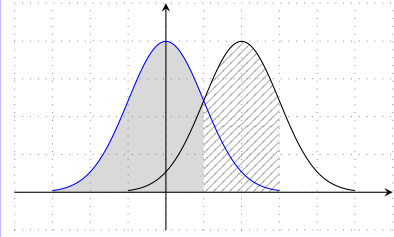

```

% \tzfnarea*: default change and <code.append>
\begin{tikzpicture}
\setztzfnarealayer{main} %
\tzhelplines(0,-1)(4,2)
\tzaxes(0,-1)(4,2)
\def\Fx{.5*(\x-1)^2-1}
\tzfn\Fx[0:3.5]
\tzfnarea*[red]\Fx[1:3]{.1}
<(2,-1) node[black]{Area}>
\end{tikzpicture}

```

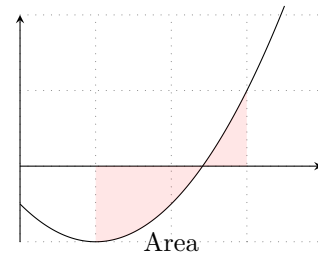

```

% \tzfnarea*
\begin{tikzpicture}
\tzhelplines(0,-2)(4,3)
\tzaxes(0,-2)(4,3){\x$}{\y$}
\def\Fx{.5*(\x-1)^2-1}
\tzfn\Fx[0:3.5]{\f(x)$}[a]
\tzfnarea*[red]\Fx[1:3]
\tzvXpointat{Fx}{1}(A)
\tzvXpointat{Fx}{3}(B)
\tzline[blue,thick](A)(A|-0,0)
\tzline[very thick](B)(B|-0,0)
\end{tikzpicture}

```

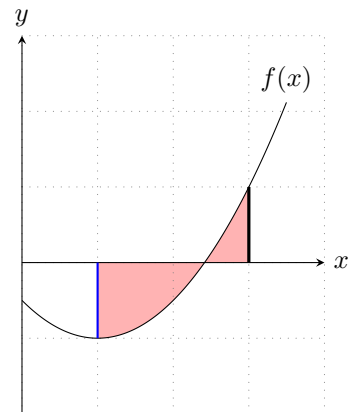

23.2.2 \tzfnarealine(')

\tzfnarealine draws one or two boundary lines of \tzfnarea using \tzto, on the behind layer by default. The layer can be changed by \setztzfnarealayer. It takes two mandatory arguments: {<path>} and {<x1>}.

- \tzfnarealine{<path>}{<x1>} draws a vertical line to the x axis at <x1>.
- \tzfnarealine{<path>}{<x1>}{<x2>} draws two vertical lines at <x1> and <x2>.

The first option [opt] controls both lines and is overwritten by each of [opt1] (for the line at <x1>) and [opt2] (for the line at <x2>). The line width is very thin by default, which can be changed by \setztzfnarealinesstyle.

You can also change the length of lines by specifying (<coor1>) and (<coor2>).

```

% syntax: minimum
\tzfnarealine{<path>}{<x1>}
% syntax: minimal
\tzfnarealine{<path>}{<x1>}{<x2>}
% syntax: medium
\tzfnarealine{<path>}{<x1>}[<opt1>]{<x2>}[<opt2>]

```

```

% syntax: full
\tzfnarealine[<opt>]{<path>}{<x1>}[<opt1>](<coor1>)
                                     {<x2>}[<opt2>](<coor2>)

% defaults:
[very thin]{<m>}{<m>}[] (0,0){} [] (0,0)

```

```

% \tzfnarealine
\begin{tikzpicture}[x=0.5cm,y=5cm,font=\scriptsize]
\tzhelplines[step=.5cm](-4,-.1)(6,.5)
\tzaxes(-4,-.1)(6,.5)
\tzfn"AA"{\tzpdfN21}[-1:5]
\tzfnarea*[pattern=north east lines]{\tzpdfN21}[1:3]
\tzfnarealine[red]{AA}{1}{3} %%
\end{tikzpicture}

```

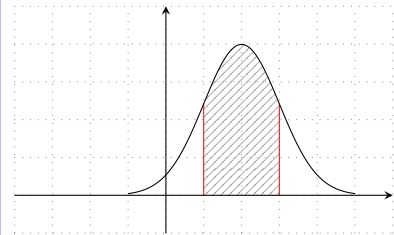

```

% \tzfnarealine: one line
\begin{tikzpicture}
\tzhelplines(0,-1)(4,2)
\tzaxes(0,-1)(4,2)
\def\Fx{.5*(\x-1)^2-1}
\tzfn\Fx[0:3.5]
\tzfnarea*[red]\Fx[1:3]{.1}<(2,-1) node[black]{Area}>
\tzfnarealine[blue]{Fx}{3}
\end{tikzpicture}

```

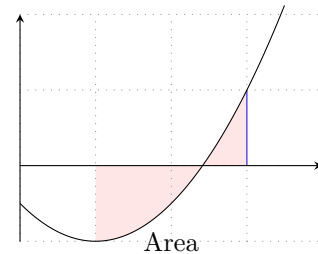

```

% \tzfnarealine: two lines
\begin{tikzpicture}
\tzhelplines(0,-1)(4,2)
\tzaxes(0,-1)(4,2)
\def\Fx{.5*(\x-1)^2-1}
\tzfn\Fx[0:3.5]
\tzfnarea*[red]\Fx[1:3]{.1}<(2,-1) node[black]{Area}>
\tzfnarealine[blue,thick]{Fx}{1}{3}[very thick,red]
\end{tikzpicture}

```

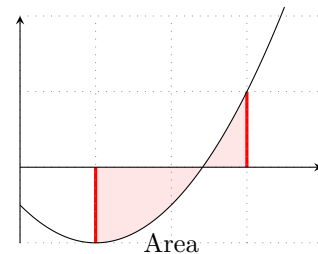

The *swap version* `\tzfnarealine'` draws one or two horizontal lines from the point $(x_i, f(x_i))$ to the y axis. Everything else is the same as in `\tzfnarealine`.

```

% \tzfnarealine'
\begin{tikzpicture}
\tzhelplines(0,-1)(4,2)
\setztzfnarealinestyle{thick}
\tzaxes(0,-1)(4,2)
\def\Fx{.5*(\x-1)^2-1}
\tzfn\Fx[0:3.5]
\tzfnarea*[blue]\Fx[1:3]{.1}<(2,-1) node[black]{Area}>
\tzfnarealine'[->,red]{Fx}{2}{3}
\end{tikzpicture}

```

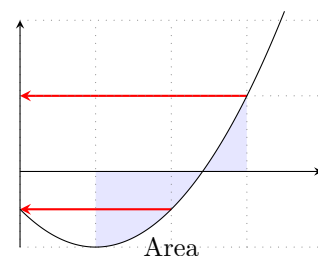

23.3 Envelope curves

23.3.1 `\tzfnmax`: Upper envelope curves

`\tzfnmax` plots the maximum of a list of functions, that is, an *upper envelope curve*. The first mandatory argument should be a comma separated list of functions. The second mandatory argument [`<domain>`] should be colon separated.

The default line width of `\tzfnmax` is `thick`.

```
% syntax: minimum
\tzfnmax{<fn list>}[<domain>]
% syntax: full
\tzfnmax[<opt>]<shift coor>"<path name>"
    {<fn list>}[<domain>]{<text>}[<node opt>]<code.append>
% remark:
- {<fn list>} should be comma separated
- [<domain>] should be of the form [<from num>:<to num>]
% defaults
[thick,samples=201]<>"{<m>}[<m>]{ }[]<>
```

```
% \tzfnmax
\begin{tikzpicture}
\tzhelplines*(4,4)
\def\Fx{x}
\def\Gx{.5*x+.5}
\def\Hx{-.25*x+2}
\tzfn{\Fx}[0:4] \tzfn{\Gx}[0:4] \tzfn{\Hx}[0:4]
\tzfnmax[blue]{\Fx,\Gx,\Hx}[0:4]{upper envelope}[1]
\end{tikzpicture}
```

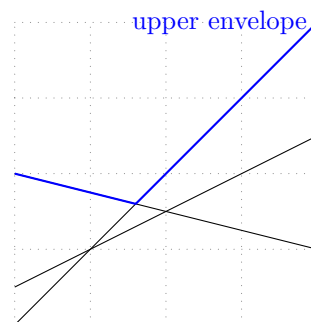

Remark: If you want sharp corners at kinked points, you may need to select an appropriate number of sample points, which is `samples=201`, by default. You can try an odd number.

If you want, you can shift and extend path using the option `<shift coor>` and `<code.append>`, respectively. You can also use `\tzfnmaxAtBegin` and `\tzfnmaxAtEnd` to extend the path of `\tzfnmax` at the beginning and at the end, respectively.

```
% shift, <code.append>
\begin{tikzpicture}
\tzhelplines*(4,5)
\def\Fx{x}
\def\Gx{.5*x+.5}
\def\Hx{-.25*x+2}
\tzfn{\Fx}[0:4] \tzfn{\Gx}[0:4] \tzfn{\Hx}[0:4]
\tzfnmax[blue,thick]{\Fx,\Gx,\Hx}[0:4]
\tzfnmaxAtBegin{ (-1,0) -- }
\tzfnmax[dashed]<0,.5>{\Fx,\Gx,\Hx}[0:4]
    < to[bend left] ++ (1,-1) >
\end{tikzpicture}
```

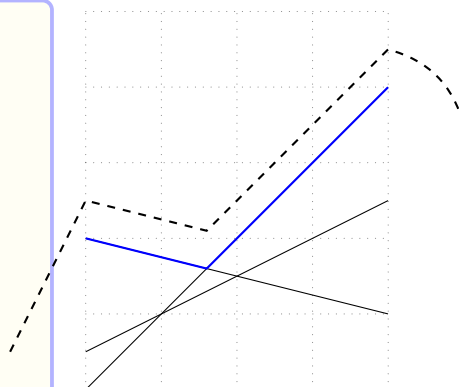

23.3.2 `\tzfnmin`: Lower envelope curves

`\tzfnmin` plots the minimum of a list of functions. `\tzfnmin` works just like `\tzfnmax`, but it draws a *lower envelope curve*.

```

% \tzXpoint
\begin{tikzpicture}[scale=.5]
\tzhelplines(8,8)
\tzaxes(8,8)
\tzto[red,bend right]"AA"(1,8)(8,1)
\tzto[blue,bend right]"BB"(0,2)(8,6)
\tzXpoint{AA}{BB}(A)
\tzdot*(A)
\end{tikzpicture}

```

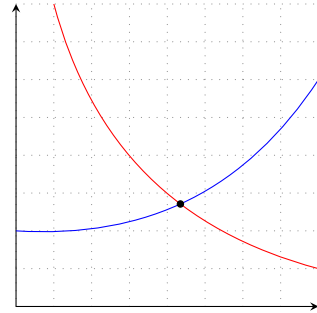

Warning: When using `\tzXpoint`, the intersection of two paths must actually exist. Otherwise, an error will occur when using coordinates.

`\tzXpoint*` The starred version `\tzXpoint*` simply adds a node dot to `\tzXpoint`. The default dot size is 2.4pt and it can be changed by the last option (`<dot size>`) or the THREE WAYS (on page 46).

```

% syntax: minimum
\tzXpoint*{<path>}{<path>}
% syntax: medium
\tzXpoint*{<path>}{<path>}(<coord name>){<label>}[<angle>]
% syntax:
\tzXpoint*{<opt>}{<path>}{<path>}
                (<coord name>)[<nth>]{<label>}[<label opt>angle](<dot size>)
% defaults
[tzdot=2.4pt]{<m>}{<m>}(intersection)[1]{ } (2.4pt)

```

```

% \tzXpoint*
\begin{tikzpicture}[scale=.5]
\tzhelplines(10,10)
\tzaxes(10,10)
\def\bgt{8-\x}
\def\Fx{\x}
\def\IC{7/\x}
\tzfn\bgt[0:8] % name path=bgt
\tzfn\Fx[0:8]{ray}[red,ar] % name path=Fx
\tzfn\IC[.8:8]{u}[r] % name path=IC
\tzXpoint*\bgt{Fx}(A){A}[[draw,red] r] % <angle> or %
  ↳ abb
\tzproj[dashed](A){$x$}{$y$}
\tzXpoint*[fill=none,red]{bgt}{IC}(B){B}[0](4pt)
\tzdot*[blue](B-2){B2}[[red]45](4pt)
\end{tikzpicture}

```

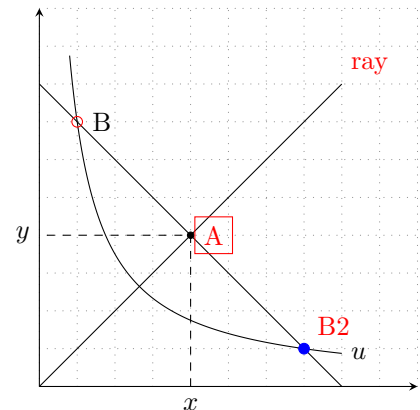

24.2 Vertical intersection points

24.2.1 `\tzvXpointat(*)`

`\tzvXpointat` determines *vertical intersection* points of a path at a specified value of x . So it takes `{<path>}` and `{<x-val>}` as mandatory arguments.

Remark: Internally, `\tzvXpointat` depends on the current bounding box, which generally does not cause a problem because it is used after paths to be intersected are formed. In case of any

problem of no intersection point, you may want to fix a bounding box using `\tzbbox` or `\tzaxes*` or TikZ's `\useasboundingbox`.

```
% syntax: minimal
\tzvXpointat{<path>}{<x-val>}{<coor name>}
% syntax: medium
\tzvXpointat{<path>}{<x-val>}{<coor name>}{<label>}[<angle>]
% syntax: full
\tzvXpointat[<opt>]{<path>}{<x-val>}{<coor name>}[<n>]
    {<label>}[<[label opt]angle>]
% defaults
[] {<m>} {<m>} (intersection) [1] {} []
```

The starred version `\tzvXpointat*` additionally prints a node dot of the size 2.4pt, by default, at the (first) intersection point.

```
% syntax: minimum
\tzvXpointat*{<path>}{<x-val>}
% syntax: medium
\tzvXpointat*{<path>}{<x-val>}{<coor name>}{<label>}[<angle>]
% syntax: full
\tzvXpointat*[<opt>]{<path>}{<x-val>}{<coor name>}[<n>]
    {<label>}[<[label opt]angle>]{<dot size>}
% defaults
[tzdot=2.4pt] {<m>} {<m>} (intersection) [1] {} [] (2.4pt)
```

```
% \tzvXpointat(*)
\begin{tikzpicture}
\tzhelplines(4,3)
\def\Fx{.5*(\x-2)^2}
\tzfn\Fx[0:4] % name path=Fx
\tzvfmat[dashed]{1}
\tzvXpointat{Fx}{1}(A)
\tzdot(A){A}[45]
\tzvXpointat*{Fx}{3.2}{B}[[red,draw]br]
\end{tikzpicture}
```

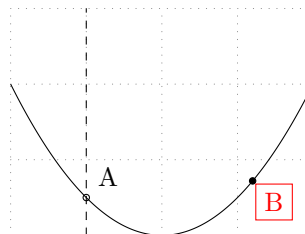

24.2.2 `\tzvXpoint(*)`

`\tzvXpoint` accepts `{<path>}` and `(<coor>)` as mandatory arguments to find *vertical intersection* points of a path at the x value of the coordinate, ignoring the y value. For example, `\tzvXpoint{mypath}(3,<y>)`, ignoring `<y>`, is equivalent to `\tzvXpointat{mypath}{3}`.

Everything else is the same as in `\tzvXpointat`.

```
% syntax
\tzvXpoint[<opt>]{<path>}{<coor>}{<coor name>}[<n>]
    {<label>}[<[label opt]angle>]
% defaults
[] {<m>} {<m>} (intersection) [1] {} []
```

The starred version `\tzvXpoint*` just adds a node dot to `\tzvXpoint`.

```

% syntax
\tzvXpoint* [<opt>] {<path>} (<coor>) (<coor name>) [<n>]
             [<label>] [<[<opt>] angle>] (<dot size>)
% defaults
[tzdot=2.4pt] {<m>} (<m>) (intersection) [1] {} [] (2.4pt)

```

`\tzvXpoint*` prints, at the first intersection point, a node dot of the size 2.4pt by default.

```

% \tzvXpoint(*)
\begin{tikzpicture}
\tzhelplines(4,3)
\def\Fx{.5*(\x-2)^2}
\tzfn\Fx[0:4] % name path=Fx
\tzcoors(1,0)(A)(3.2,0)(B);
\tzvfn[dashed](1,0)
\tzvXpoint{Fx}(A)(Ax)
\tzdot(Ax){Ax}[45]
\tzvXpoint*{Fx}(B){B}[[red,draw]br] % abb
\end{tikzpicture}

```

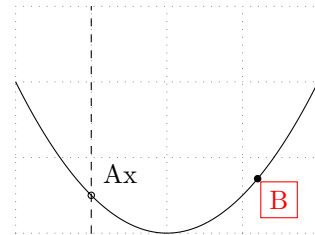

24.3 Horizontal intersection points

24.3.1 `\tzhXpointat(*)`

`\tzhXpointat` determines *horizontal intersection* points of a path at a specified value of y . So it takes `{<path>}` and `{<y-val>}` as mandatory arguments.

```

% syntax: minimal
\tzhXpointat{<path>}{<y-val>}(<coor name>)
% syntax: medium
\tzhXpointat{<path>}{<y-val>}(<coor name>){<label>} [<angle>]
% syntax: full
\tzhXpointat [<opt>] {<path>}{<y-val>}(<coor name>) [<n>] {<label>} [<[<label opt>] angle>]
% defaults
[] {<m>} {<m>} (intersection) [1] {} []

```

The starred version `\tzhXpointat*` additionally prints a node dot of the size 2.4pt, by default, at the intersection point.

```

% syntax: minimum
\tzhXpointat*{<path>}{<y-val>}
% syntax: medium
\tzhXpointat*{<path>}{<y-val>}(<coor name>){<label>} [<angle>]
% syntax: full
\tzhXpointat* [<opt>] {<path>}{<y-val>}(<coor name>) [<n>]
             {<label>} [<[<label opt>] angle>] (<dot size>)
% defaults
[tzdot=2.4pt] {<m>} {<m>} (intersection) [1] {} [] (2.4pt)

```

```

% \tzhXpointat(*)
\begin{tikzpicture}
\tzhelplines*(4,3)
\def\Fx{.5*(\x-2)^2}
\tzfn\Fx[0:4] % name path=Fx
\tzhXpointat{Fx}{1}(A)
\tzdot(A){A}[0]
\tzhfnat[dashed]{1.5}
\tzhXpointat*{Fx}{1.5}(X){X}[45]
\tzdot*(X-2){Y}[[red,draw]al] % abb
\end{tikzpicture}

```

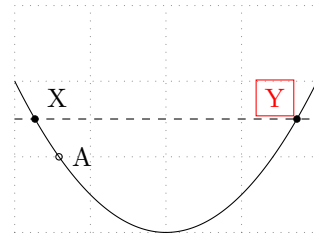

24.3.2 \tzhXpoint(*)

\tzhXpoint accepts `{<path>}` and `(<coord>)` as mandatory arguments to find *horizontal intersection* points of a path at the *y* value of the coordinate, ignoring the *x* value. For example, `\tzhXpoint{mypath}(<x>,3)`, ignoring `<x>`, is equivalent to `\tzhXpointat{mypath}{3}`.

Everything else is the same as in \tzhXpointat.

```

% syntax
\tzhXpoint [<opt>]{<path>}(<coord>)(<coord name>)[<n>]{<label>}[<[label opt]angle>]
% defaults
[] {<m>}(<m>)(intersection)[1]{}[]

```

The starred version \tzhXpoint* just adds a node dot to \tzhXpoint.

```

% syntax
\tzhXpoint* [<opt>]{<path>}(<coord>)(<coord name>)[<n>]
<label>[<[label opt]angle>](<dot size>)
% defaults
[tzdot=2.4pt]{<m>}(<m>)(intersection)[1]{}[] (2.4pt)

```

\tzhXpoint* prints, at the (first) intersection point, a node dot of the size 2.4pt, by default.

```

% \tzhXpoint(*)
\begin{tikzpicture}
\tzhelplines*(4,3)
\def\Fx{.5*(\x-2)^2}
\tzfn\Fx[0:4] % name path=Fx
\tzcoords(0,1)(A)(0,1.5)(B);
\tzhXpoint{Fx}(A)(A)
\tzdot(A){A}[0]
\tzhfn[dashed](0,1.5)
\tzhXpoint*{Fx}(X){X}[45]
\tzdot*(X-2){Y}[[red,draw]al] % abb
\end{tikzpicture}

```

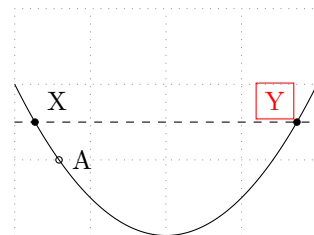

24.4 \tzLFnXpoint(*): Intersection point of linear functions

Sometimes you may want to *quickly* find intersection point of two linear functions *without specifying path names*.

\tzLFnXpoint finds the solution of two linear functions without printing anything by default. You can name it and use it.

```

% syntax: minimum
\tzLFnXpoint{<\fn>}{<\fn>}
% syntax: medium
\tzLFnXpoint{<\fn>}{<\fn>}(<coor name>){<label>}[<[<label opt>]angle>]
% syntax: full
\tzLFnXpoint[<opt>]{<\fn>}{<\fn>}(<coor name>)
    {<label>}[<[<label opt>]angle>](<dot size>)
% defaults
[tzdot=2.4pt,draw=none,mimumum size=0pt]{<m>}{<m>}[0]{}[] (2.4pt)

```

```

% \tzLFnXpoint
\begin{tikzpicture}[scale=.8]
\tzhelplines(4,3)
\tzfn[yellow]{\x}[0:3]
\tzfn[yellow]{3-\x}[0:3]
\tzLFnXpoint{\x}{3-\x}(A) % invisible
\tzto+[->,bend left](A)(2,-1)
\end{tikzpicture}

```

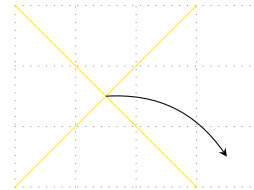

The starred version `\tzLFnXpoint*` additionally print a filled node dot at the solution of two linear functions of $\backslash x$.

```

% syntax: minimum
\tzLFnXpoint*{<\fn>}{<\fn>}
% syntax: medium
\tzLFnXpoint*{<\fn>}{<\fn>}(<coor name>){<label>}[<[<label opt>]angle>]
% syntax: full
\tzLFnXpoint*[<opt>]{<\fn>}{<\fn>}(<coor name>)
    {<label>}[<[<label opt>]angle>](<dot size>)
% defaults
*[tzdot=2.4pt,fill]{<m>}{<m>}[0]{}[] (2.4pt)

```

```

% \tzLFnXpoint*
\begin{tikzpicture}[scale=.8]
\tzhelplines(4,3)
\tzLFnXpoint*{\x}{3-\x}(A){A}[[red,draw]90] %%
\tzline+[blue](A)(2,-1)
\end{tikzpicture}

```

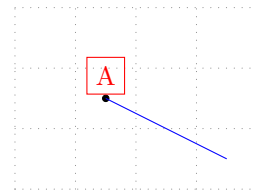

25 Secant and Tangent Lines

25.1 Secant lines

25.1.1 `\tzsecantat`

`\tzsecantat` draws a line segment or a *secant* line of a curve, on the **behind** layer by default. `\tzsecantat` accepts three mandatory arguments. Three mandatory arguments are a path name and two values of x : `{<path>}`, `{<from-x>}`, and `{<to-x>}`. With `\setztzsecantlayer`, you can change the layer, like `\setztzsecantlayer{main}`.

```

% syntax: minium
\tzsecantat{<path>}{<from-x>}{<to-x>}

```

```

% syntax: medium
\tzsecantat{<path>}{<from-x>}{<to-x>}[<domain>]{<text>}[<node opt>]
% syntax: full
\tzsecantat[<opt>]<shift coor>"path name"
    {<path>}{<from-x>}{<to-x>}[<domain>]{<text>}[<node opt>]<code.append>
% defaults
[]<>""{<m>}{<m>}{<m>}[]{}[]<>

```

Domain The domain of the form [`<from num:to num>`] is optional. Without specifying the optional domain, `\tzsecantat` draws a line segment connecting two points on the (curved) path.

```

% \tzsecantat
\begin{tikzpicture}[scale=.5]
\tzhelplines(8,6)
\tzaxes(-1,-1)(8,6){$x$}{$y$}
\tzbezier+"curve"(.5,1)(1,6)(-1,-4)(7,5)
\tzsecantat[thick,red]{curve}{1}{3}
\tzsecantat[thick,red]{curve}{1}{4}
\tzsecantat[thick,red]{curve}{1}{7}
\end{tikzpicture}

```

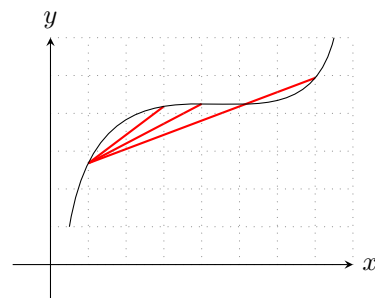

Specifying the option [`<domain>`], you can extend (or shorten) the line of `\tzsecantat`.

```

% \tzsecantat: domain
\begin{tikzpicture}[scale=.5]
\tzhelplines(8,6)
\tzaxes(-1,-1)(8,6){$x$}{$y$}
\tzbezier+"curve"(.5,1)(1,6)(-1,-4)(7,5){curve}[ar]
\tzsecantat[blue]{curve}{1}{3}[0:5]{secant line}[a]
\tzsecantat[thick,red]{curve}{1}{4}
\tzsecantat[blue,dashed]{curve}{1}{7}[0:8]
\end{tikzpicture}

```

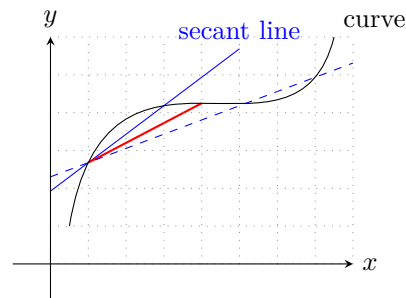

Shift You can move `\tzsecantat` by specifying the option `<shift coor>`.

```

% \tzsecantat: domain
\begin{tikzpicture}[scale=.5]
\tzhelplines(8,6)
\tzaxes(-1,-1)(8,6){$x$}{$y$}
\tzbezier+"curve"(.5,1)(1,6)(-1,-4)(7,5){curve}[ar]
\tzsecantat[thick,red]{curve}{1}{4}
\tzsecantat[blue]{curve}{1}{3}[0:5]{secant line}[a]
\tzsecantat[blue]<1,-1>{curve}{1}{3}[0:5]{shifted}[r]
\end{tikzpicture}

```

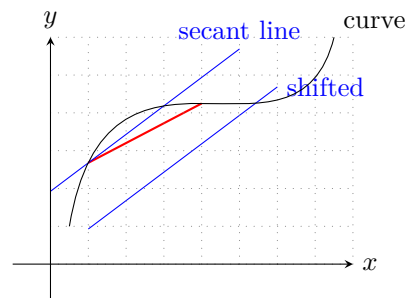

Naming paths By specifying the option "`<path name>`" you can name a path of `\tzsecantat`, and use it to find intersection points.

```

% \tzsecantat: shift, name path (intersection)
\begin{tikzpicture}[scale=.5]
\tzhelplines(8,6)
\tzaxes(-1,-1)(8,6){$x$}{$y$}
\tzbezier+"curve"(.5,1)(1,6)(-1,-4)(7,5){curve}[ar]
\tzsecantat[thick,red]{curve}{1}{4}
\tzsecantat[blue]{curve}{1}{3}[0:5]{secant line}[a]
\tzsecantat[blue]<1,-1>"shift"{curve}{1}{3}[0:5] %%
\tzvXpointat*{shift}{3}{X}[-45]
\tzticksx(-1mm:2mm){3/$x=3$}[scale=.7]
\end{tikzpicture}

```

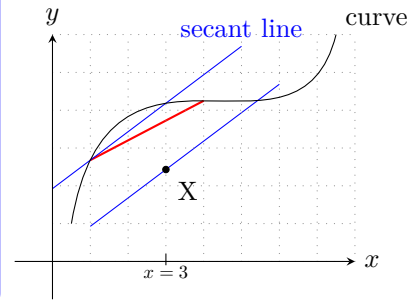

<code.append> You can extend the path of \tzsecantat by writing TikZ code in the last optional argument <code.append>.

```

% \tzsecantat: <code.append>
\begin{tikzpicture}[scale=.5]
\tzhelplines(8,6)
\tzaxes(-1,-1)(8,6){$x$}{$y$}
\tzbezier+"curve"(.5,1)(1,6)(-1,-4)(7,5){curve}[ar]
\tzsecantat[blue]{curve}{1}{3}[0:5]{secant line}[a]
\tzsecantat[blue,->>]<1,-1>"shift"{curve}{1}{3}[0:5] %%
< --++(1,-3) node [red,b] {Ends!} >
\tzvXpointat*{shift}{3}{X}[-45]
\end{tikzpicture}

```

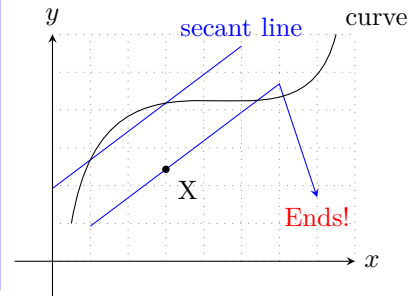

25.1.2 \tzsecant

\tzsecant uses two *coordinates instead of two values of x* to draw a line segment or a *secant* line of a curve, on the *behind* layer by default. You need to specify a path name and two coordinates, then \tzsecant uses the *x* values of the two coordinates.

Everything else is the same as in \tzsecantat.

You can change the layer with \settzsecantlayer.

```

% syntax: minium
\tzsecant{<path>}<coor><coor>
% syntax: medium
\tzsecant{<path>}<coor><coor>[<domain>]{<text>}[<node opt>]
% syntax: full
\tzsecant[<opt>]<shift coor>"path name"
<path>(<coor>)<coor>[<domain>]{<text>}[<node opt>]<code.append>
% defaults
[]<>""{<m>}<coor>[<coor>][<node opt>]<code.append>

```

The domain should be of the form [*<from num>*:*<to num>*]. Without specifying the optional domain, \tzsecant draws a line segment connecting two points on the (curved) path.

```

% \tzsecant: domain
\begin{tikzpicture}[scale=.5]
\tzhelplines(8,6)
\tzaxes(-1,-1)(8,6){$x$}{$y$}
\tzbezier+"curve"(.5,1)(1,6)(-1,-4)(7,5){curve}[ar]
\tzcoor(1,0)(K)
\tzsecant[blue]{curve}(K)(3,0)[0:5]{secant line}[a]
\tzsecant[thick,red]{curve}(K)(4,0)
\tzsecant[blue,dashed]{curve}(K)(7,0)[0:8]
\end{tikzpicture}

```

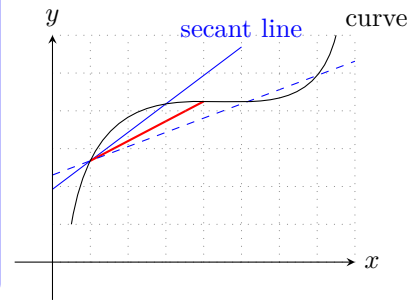

With the last option `.append` you can extend the path of `\tzsecantat`.

```

% \tzsecant: shift, <code.append>
\begin{tikzpicture}[scale=.5]
\tzhelplines(8,6)
\tzaxes(-1,-1)(8,6){$x$}{$y$}
\tzbezier+"curve"(.5,1)(1,6)(-1,-4)(7,5){curve}[ar]
\tzcoor(1,0)(K)
\tzsecant[blue]{curve}(K)(3,0)[0:5]{secant line}[a]
\tzsecant[blue,-><1,-1>"shift"{curve}(K)(3,0)[0:5] %%
< --++(1,-3) node [red,b] {Ends!} >
\tzvXpointat*{shift}{3}{X}[-45]
\end{tikzpicture}

```

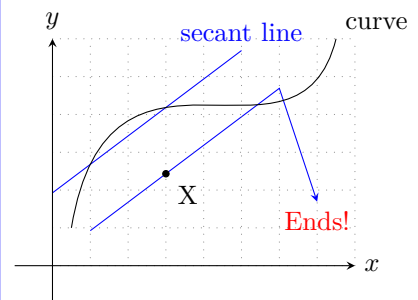

25.2 Tangent lines

25.2.1 \tztangentat

`\tztangentat` draws a *tangent* line to a curve at a specified value of x . Three mandatory arguments are a curve name, a value of x , and a domain: `{<path>}`, `{<x-val>}`, and `[domain]`. By default, the tangent line is drawn on the `behind` layer, which can be changed by `\setztangentlayer`, like `\setztangentlayer{main}`.

Remark: To calculate the slope at x , x varies over the interval $(x - \varepsilon_1, x + \varepsilon_2)$ and $\varepsilon_1 = \varepsilon_2 = 0.01$, by default. So the slope of tangent line is only *approximate*.

```

% syntax: minimum
\tztangentat{<path>}{<x-val>}[<domain>]
% syntax: medium
\tztangentat{<path>}{<x-val>}[<domain>]{<text>}[<node opt>]
% syntax: full
\tztangentat[<opt>]<shift coor>"<path name>"
{<path>}{<x-val>}(<epsilon1>,<epsilon2>)[<domain>]
{<text>}[<node opt>]<code.append>
% The domain should be of the form [<from:to>]
% defaults
[]<>""{<m>}{<m>}(0.01,.01)[<m>]{ }[]<>

```

Domain The mandatory argument `[<domain>]` should be of the form `[<from num:to num>]`.

```

% \tztangentat
\begin{tikzpicture}[scale=.5]
\tzhelpplanes(9,8)
\tzaxes(9,8)
\tzplotcurve"AA"(1,7)(3,3)(8,1);
\tztangentat{AA}{2} [.5:4]
\tztangentat[blue]{AA}{4}[1:7]{tangent}[red,b]
\zvXpointat*{AA}{4}
\zticksx{1,7}
\end{tikzpicture}

```

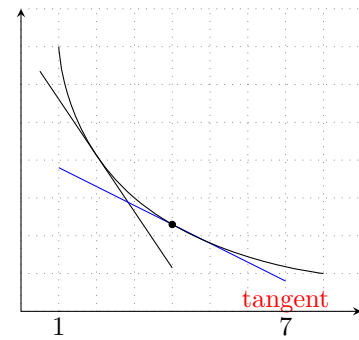

Shift You can move the tangent line by specifying the option `<shift coor>`.

```

% \tztangentat: shift
\begin{tikzpicture}[scale=.5]
\tzhelpplanes(9,8)
\tzaxes(9,8)
\tzplotcurve"AA"(1,7)(3,3)(8,1);
\tztangentat{AA}{2} [.5:4]
\tztangentat[blue]{AA}{4}[1:7]{tangent}[red,b]
\tztangentat[blue]<2,1>{AA}{4}[1:7]{tangent'}[r]
\zvXpointat*{AA}{4}
\zticksx{1,7}
\end{tikzpicture}

```

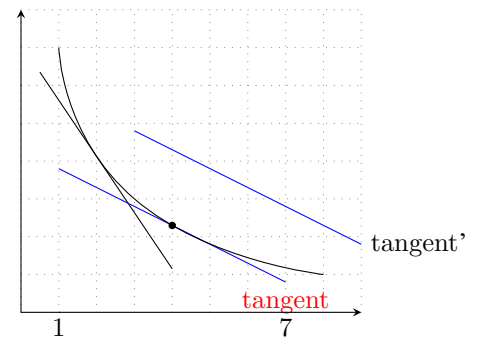

Naming paths By specifying the option "`<path name>`", you can name the path of `\tztangentat` and use it to find intersection points.

```

% \tztangentat: name path (intersection)
\begin{tikzpicture}[scale=.5,font=\footnotesize]
\tzhelpplanes(9,8)
\tzaxes(9,8)
\tzplotcurve"AA"(1,7)(3,3)(8,1);
\tztangentat{AA}{2} [.5:4]
\tztangentat[blue]{AA}{4}[1:7]{tangent}[red,b]
\zvXpointat*{AA}{4}
\tztangentat[blue]
<2,1>"BB"{AA}{4}[1:7]{tangent'}[r]
\zvXpointat*[blue]{BB}{5}(X){x}[45](3pt)
\zproj(X){x_1}{x_2}
\end{tikzpicture}

```

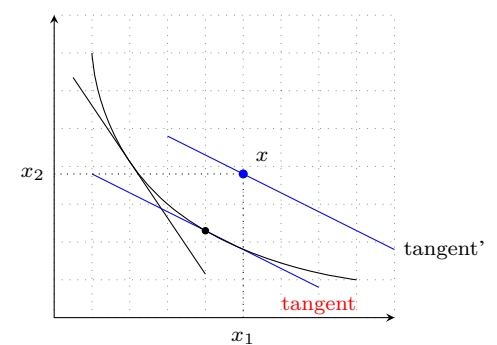

`<code.append>` You can extend the path of `\tztangentat` by writing TikZ code in the last optional argument `<code.append>`.

```

% \tztangentat: <code.append>
\begin{tikzpicture}[scale=.5,font=\footnotesize]
\tzhelplices(9,8)
\tzaxes(9,8)
\tzplotcurve"AA"(1,7)(3,3)(8,1);
\tztangentat{AA}{2} [.5:4]
\tztangentat[blue]{AA}{4}[1:7]{tangent}[red,b]
\zvXpointat*{AA}{4}
\tztangentat[blue,-><2,1>"BB"{AA}{4}[1:7]
< to [bend right] ++(-1,3) node [a] {Ends!} >
\zvXpointat*[blue]{BB}{5}(X){$x$}[45](3pt)
\tzproj(X){$x_1$}{$x_2$}
\end{tikzpicture}

```

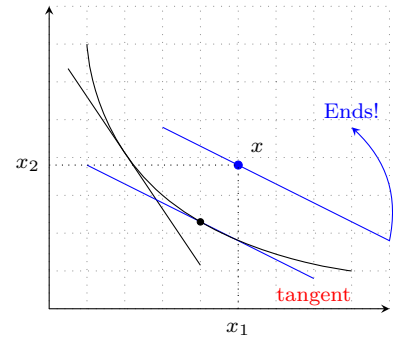

Variations Since the slope of the tangent line is *approximate*, sometimes you may want to change the variation interval to get better results. You can change ε_1 and ε_2 by specifying the option `(<epsilon1,epsilon2>)` immediately after the mandatory argument `{<x-val>}`. Or you can change the variations by the macro `\setztangentepsilon`, like `\setztangentepsilon{ ε_1 }{ ε_2 }`. The effect remains until the end of `tikzpicture` environment unless changed again.

```

% \tztangentat: variations, shift
\begin{tikzpicture}[scale=.5,font=\footnotesize]
\tzhelplices(9,8)
\tzaxes(9,8)
\tzplotcurve"AA"(1,7)(3,3)(8,1);
\tztangentat[blue!50,dashed]{AA}{4}[1:7]
\setztangentepsilon{0.005}{0.01} %%
\tztangentat[blue]{AA}{4}[1:7]{corrected}[r]
\tztangentat[red]<0,1>{AA}{4}[1:7]{shifted}[r] %%
\end{tikzpicture}

```

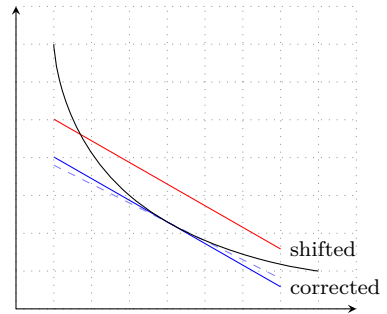

25.2.2 \tztangent

`\tztangent` uses a *coordinate instead of a value of x* to draw a *tangent* line to a curve. `\tztangent` accepts three mandatory arguments: `{<path>}`, `(<coor>)`, and `[<domain>]`.

The value of y in `(<coor>)` is ignored. For example, `\tztangent{curve}(4,y)` is equivalent to `\tztangentat{curve}{4}` for any y .

Everything else is the same as in \tztangentat.

```

% syntax: minimum
\tztangent{<path>}(<coor>)[<domain>]
% syntax: medium
\tztangent{<path>}(<coor>)[<domain>]{<text>}[<node opt>]
% syntax: full
\tztangent[<opt>]<shift coor>"<path name>"
{<path>}(<coor>)(<epsilon1>,<epsilon2>)[<domain>]
{<text>}[<node opt>]<code.append>
% The domain should be of the form [<from:to>]
% defaults
[<>]"{<m>}(<m>)(.01,.01)[<m>]{}[]<>

```

```

% \tztangent
\begin{tikzpicture}[scale=.5]
\tzhelplices(9,8)
\tzaxes(9,8)
\tzplotcurve"AA"(1,7)(3,3)(8,1);
\tzcoors(2,0)(K2)(4,0)(K4);
\tztangent{AA}(K2)[.5:4]
\tztangent[blue]{AA}(K4)[1:7]{tangent}[red,b]
\tzvXpoint*{AA}(K4)
\zticksx{1,7}
\end{tikzpicture}

```

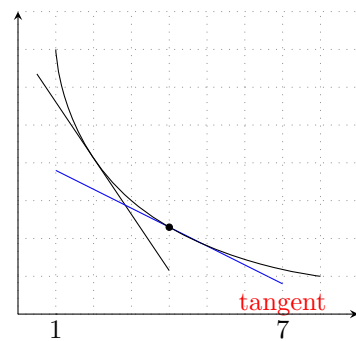

You can shift the tangent line and extend its path.

```

% \tztangent: shift, <code.append>
\begin{tikzpicture}[scale=.5,font=\footnotesize]
\tzhelplices(9,8)
\tzaxes(9,8)
\tzplotcurve"AA"(1,7)(3,3)(8,1);
\tzcoors(2,0)(K2)(4,0)(K4);
\tztangent{AA}(K2)[.5:4]
\tztangent[blue]{AA}(K4)[1:7]{tangent}[red,b]
\tzvXpoint*{AA}(K4)
\tztangent[blue,->]<2,1>"BB"{AA}(K4)[1:7]
  < to [bend right] ++(-1,3) node [a] {Ends!} >
\tzvXpoint*[blue]{BB}(5,0)(X){$x$}[45](3pt)
\tzproj(X){$x_1$}{$x_2$}
\end{tikzpicture}

```

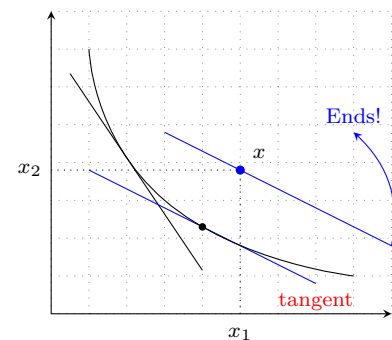

You can control the interval of variations of x by the option ($\langle\epsilon_1,\epsilon_2\rangle$) or the macro `\setztangentepsilon`.

```

% \tztangent: variations, shift
\begin{tikzpicture}[scale=.5,font=\footnotesize]
\tzhelplices(9,8)
\tzaxes(9,8)
\tzplotcurve"AA"(1,7)(3,3)(8,1);
\tzplotcurve[blue!50,dashed]{AA}(4,0)[1:7]
\setztangentepsilon{0.005}{0.01} %%
\tztangent[blue]{AA}(4,0)[1:7]{corrected}[r]
\tztangent[red]<0,1>{AA}(4,0)[1:7]{shifted}[r] %%
\end{tikzpicture}

```

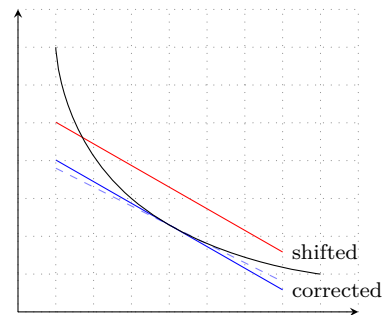

25.3 Slope lines and normal lines

25.3.1 \tzslopeat

`\tzslopeat` draws a slope line to a path with a specified length. The mandatory arguments are $\langle\text{path}\rangle$, $\langle x \rangle$, and $\langle\text{length}\rangle$. The tangent point is the middle point of the slope line.

By default, the slope lines are drawn on the behind layer. You can change the layer, like `\setztzslodelayer{main}`.

Remark: The slope is *approximate* and you can manipulate the slope by changing the variation interval with the option ($\langle\epsilon_1,\epsilon_2\rangle$). The default is $(\epsilon_1,\epsilon_2) = (0.01,0.01)$. You can also use `\setztzlopeepsilon{<epsilon1>}{<epsilon2>}` before the macro `\tzslopeat`, which is valid until the end of the `tikzpicture` environment, unless changed again.

```

% syntax: minimum
\tzslopeat{<path>}{<x-val>}{<length>}
% syntax: minimum (for normal line)
\tzslopeat{<path>}{<x-val>}{<length>}[90] % or [-90]
% syntax: full
\tzslopeat[<opt>]{<path>}{<x-val>}(<epsilon1>,<epsilon2>){<length>}[<rotate>]
    {<text>}[<node opt>]<code.append>
% defaults
[] {<m>}{<m>}(.01,.01){<m>}[0]{}[]<>

```

```

% \tzslopeat
\begin{tikzpicture}
\tzhelplines*(5,4)
\tzcoors*(0,0) (A) (2,2) (B) {B} [b] (3.5,1) (C) (5,3) (D);
\tztos[thick]"AA"(A) [out=0,in=180]
    (B) [out=0,in=180]
    (C) [out=0,in=255]
    (D);
\tzslopeat[->,red,thick]{AA}{1}{3cm}
\tzslopeat[blue]{AA}{2}{2cm}
\tzslopeat{AA}{4}{2cm}{f'(4)}[r]
\end{tikzpicture}

```

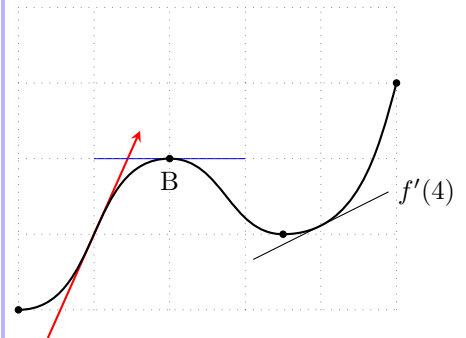

```

% \tzslopeat: repeated
\begin{tikzpicture}
\tzhelplines(1,1)(5,4)
\tzcoors*(0,1) (A) (2,3) (B) (4,2) (C);
\tzparabola"AA"(A) (B) (C)
\foreach \x in {1,1.5,...,3.5}
{ \tzslopeat[thick,red]{AA}{\x}{2cm} }
\end{tikzpicture}

```

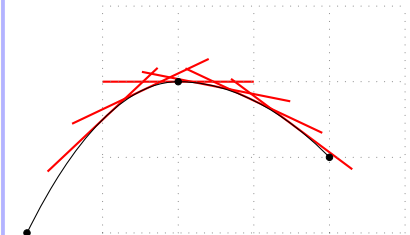

Normal lines With the option [`<rotate>`] *immediately* after the last mandatory argument [`<length>`], you can draw a *normal line* to a curve by rotating the slope lines 90° or -90° .

```

% \tzslopeat: slopes and normals
\begin{tikzpicture}
\tzhelplines*(5,4)
\tzcoors*(0,0) (A) (2,2) (B) {B} [b] (3.5,1) (C) (5,3) (D);
\tztos[thick]"AA"(A) [out=0,in=180]
    (B) [out=0,in=180]
    (C) [out=0,in=255]
    (D);
\tzslopeat[red]{AA}{1}{3cm}
\tzslopeat[blue]{AA}{2}{2cm}
\tzslopeat{AA}{4}{2cm}{f'(4)}[r]
% normal lines: rotate: [90] or [-90]
\tzslopeat[->,blue]{AA}{1}{1cm}[90]
\tzslopeat[->,red]{AA}{2}{2cm}[90]
\tzslopeat[->,red]{AA}{4}{1cm}[-90]{normal}[b]
\end{tikzpicture}

```

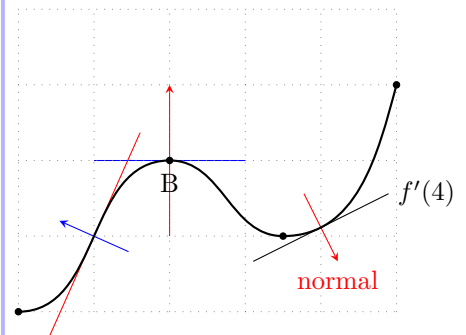

25.3.2 \tzslopeat'

The *swap version* \tzslopeat' draws a slope line with the opposite direction of \tzslopeat.

```
% \tzslopeat'
\begin{tikzpicture}
\tzhelplines*(5,4)
\tzcoors*(0,0) (A) (2,2) (B) {\B} [b] (3.5,1) (C) (5,3) (D);
\tztos[thick]"AA"(A) [out=0,in=180]
      (B) [out=0,in=180]
      (C) [out=0,in=255]
      (D);
\tzslopeat' [->,red,thick]{AA}{1}{3cm} %%
\tzslopeat [->,blue]{AA}{2}{2cm}
\tzslopeat' [->]{AA}{4}{2cm}{f'(4)} [r] %%
\end{tikzpicture}
```

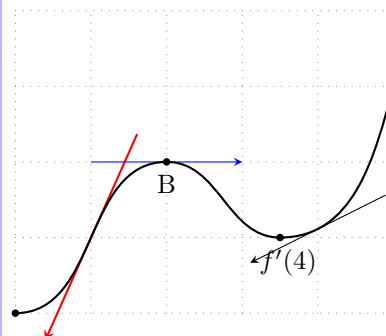

Remark: \tzslopeat{AA}{2}{2cm}[-180] is equivalent to \tzslopeat'{AA}{2}{2cm}.

- Without the arrows, \tzslopeat and \tzslopeat' give the same result except where the labels are placed.
- The swap version \tzslopeat' does not change its direction with the option [`<rotate>`].

25.3.3 \tzslope

\tzslope is the same as \tzslopeat, except for one thing. \tzslope uses a coordinate instead of a value of x to draw slope lines. So the mandatory arguments of \tzslope is `{<path>}`, `(<coor>)`, and `{<length>}`. The y value of `(<x,y>)` is ignored.

```
% syntax
\tzslope [<opt>]{<path>}(<x,y>)(<epsilon1>,<epsilon2>){<length>}[<angle>]
      {<text>}[<pos,opt>]<code.append>
% defaults
[] {<m>}(<m>)(.01,.01){<m>}[0]{}[]<>
```

```
% \tzslope: slopes and normals
\begin{tikzpicture}
\tzhelplines*(5,4)
\tzcoors*(0,0) (A) (2,2) (B) {\B} [b] (3.5,1) (C) (5,3) (D);
\tztos[thick]"AA"(A) [out=0,in=180]
      (B) [out=0,in=180]
      (C) [out=0,in=255]
      (D);
\tzslope[red]{AA}(1,0){3cm}
\tzgetxyval(B){\Bx}{\By}
\tzslopeat[blue]{AA}{\Bx}{2cm}
\tzslope{AA}(4,0){2cm}{f'(4)} [r]
% normal lines: rotate: [90] or [-90]
\tzslope[->,blue]{AA}(1,0){1cm}[90]
\tzslope[->,red]{AA}(B){2cm}[90]
\tzslope[->,red]{AA}(4,0){1cm}[-90]{normal}[b]
\end{tikzpicture}
```

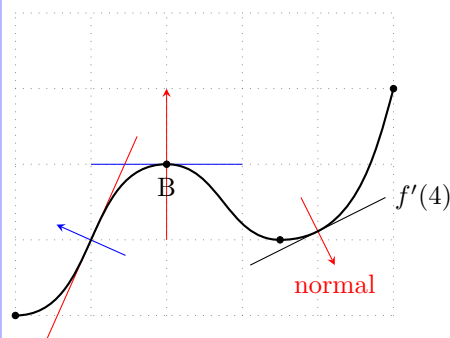

```

% \tzslope: repeated
\begin{tikzpicture}
\tzhelplines(1,1)(5,4)
\tzcoors*(0,1)(A)(2,3)(B)(4,2)(C);
\tzparabola"AA"(A)(B)(C)
\foreach \x in {1,1.5,...,3.5}
{ \tzslope[thick,red]{AA}(\x,0){2cm} }
\end{tikzpicture}

```

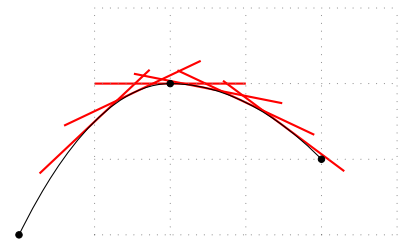

You can add TikZ code with the last option `<code.append>`.

```

% \tztangent, \tzslope: extend/shorten lines
\begin{tikzpicture}[scale=.5]
\tzhelplines(9,8)
\tzaxes(9,8)
\tzplotcurve"AA"(1,7)(3,3)(8,1);
\tzcoors(2,0)(K2)(4,0)(K4);
\tzslope[red,tzextend={1cm}{2cm}]{AA}(K2){1cm} %%
\tztangent[blue]{AA}(K4)[1:7]{tangent}[red,b]
\tzslope[->]{AA}(K4){0.1pt}{90}
<--([turn]0:2cm)node[r]{gradient}> %%
\tzvXpoint*{AA}(K4)
\tzticksx{1,7}
\end{tikzpicture}

```

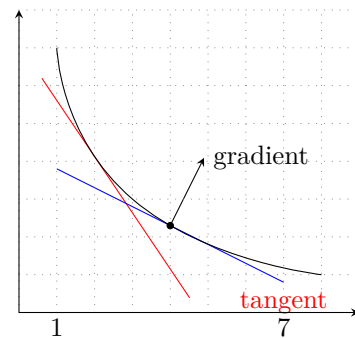

25.3.4 \tzslope'

The *swap version* `\tzslope'` draws a slope line with the opposite direction of `\tzslope`.

```

% \tzslope'
\begin{tikzpicture}
\tzhelplines*(5,4)
\tzcoors*(0,0)(A)(2,2)(B){B}[b](3.5,1)(C)(5,3)(D);
\tztos[thick]"AA"(A)[out=0,in=180]
(B)[out=0,in=180]
(C)[out=0,in=255]
(D);
\tzslope'[->,red,thick]{AA}(1,0){3cm}
\tzslope'[->,blue]{AA}(B){2cm}
\tzslope'[->]{AA}(4,0){2cm}{\$f'(4)\$}[r]
\end{tikzpicture}

```

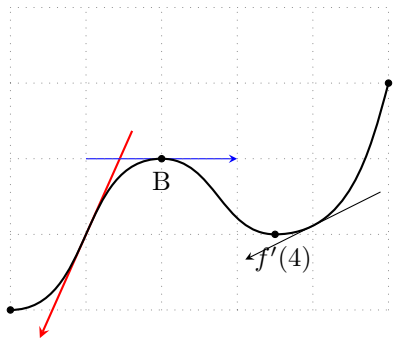

Remark: `\tzslope{AA}{2}{2cm}[-180]` is equivalent to `\tzslope'{AA}{2}{2cm}`.

- Without the arrows, `\tzslope` and `\tzslope'` give the same result except where the labels are placed.
- The swap version `\tzslope'` does not change its direction with the option `<rotate>`.

25.4 Normal lines

25.4.1 \tznormalat

`\tznormalat` draws a normal line *from a point* on a graph at $x = \langle x\text{-val} \rangle$. The mandatory arguments are `{<path>}`, `{<x-val>}`, and `{<length>}`.

By default, the normal lines are drawn on the *behind* layer. You can change the layer, like `\setztznormallayer{main}`.

Remark: The slope of a normal *perpendicular to the slope line* is *approximate* and can be changed by changing the variation interval with the option (`<epsilon1,epsilon2>`). The default is $(\epsilon_1, \epsilon_2) = (0.01, 0.01)$. You can also use `\setztznormalepsilon{<epsilon1>}{<epsilon2>}` before the macro `\tznormalat`, which is valid until the end of the `tikzpicture` environment, unless changed again.

```
% syntax: minimum
\tznormalat{<path>}{<x-val>}{<length>}
% syntax: full
\tznormalat[<opt>]{<path>}{<x-val>}{<epsilon1>,<epsilon2>}{<length>}[<rotate>]
    {<text>}[<node opt>]<code.append>
% defaults
[] {<m>}{<m>}{.01,.01}{<m>}[90]{}[]<>
```

```
% \tznormalat
\begin{tikzpicture}
\tzhelplines*(5,4)
\tzcoors*(0,0) (A) (2,2) (B) {B} [b] (3.5,1) (C) (5,3) (D) ;
\tztos[thick]"AA"(A) [out=0,in=180]
    (B) [out=0,in=180]
    (C) [out=0,in=255]
    (D) ;
\tzslopeat [red,thick]{AA}{1}{3cm}
\tzslopeat [blue]{AA}{2}{2cm}
\tzslopeat {AA}{4}{2cm}{f'(4)} [r]
\tznormalat [->,red,thick]{AA}{1}{3cm}
\tznormalat [->,blue]{AA}{2}{2cm}
\tznormalat [->]{AA}{4}{2cm}{normal} [r]
\end{tikzpicture}
```

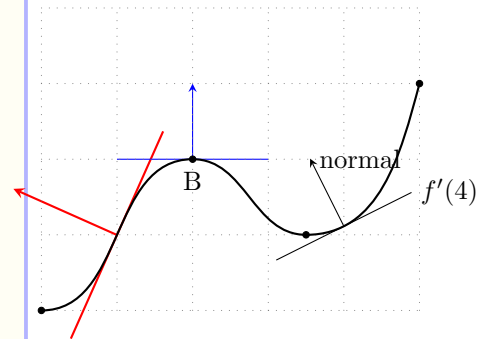

You can change its direction with the option `[<rotate>]` after the argument `{<length>}`.

```
% \tznormalat: rotated
\begin{tikzpicture}
\tzhelplines*(5,4)
\tzcoors*(0,0) (A) (2,2) (B) {B} [b] (3.5,1) (C) (5,3) (D) ;
\tztos[thick]"AA"(A) [out=0,in=180]
    (B) [out=0,in=180]
    (C) [out=0,in=255]
    (D) ;
\tzslopeat [red]{AA}{2}{3cm}
\tznormalat [->,blue]{AA}{2}{2cm}
\tznormalat [->,blue]{AA}{2}{2cm} [45] {45\textdegree} [ar]
\tznormalat [->,blue]{AA}{2}{2cm} [135]
\end{tikzpicture}
```

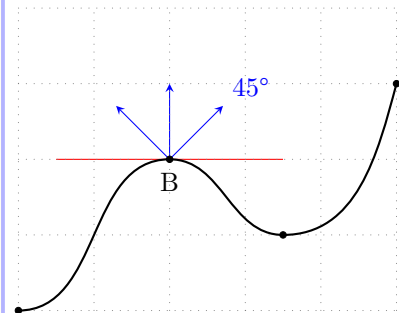

25.4.2 `\tznormalat'`

The *swap version* `\tznormalat'` draws a normal line with the opposite direction of `\tznormalat`.

```
% syntax: minimum
\tznornalatt{<path>}{<x-val>}{<length>}
% syntax: full
\tznornalatt[<opt>]{<path>}{<x-val>}{<epsilon1>,<epsilon2>}{<length>}[<rotate>]
    {<text>}[<node opt>]<code.append>
```

```
% defaults
[] {<m>}{<m>}{.01,.01}{<m>}{-90}{} [] <>
```

```
% \tznormalat' (swap version)
\begin{tikzpicture}
\tzhelplines*(5,4)
\tzcoors*(0,0) (A) (2,2) (B) {B} [b] (3.5,1) (C) (5,3) (D);
\tztos[thick]"AA"(A) [out=0,in=180]
      (B) [out=0,in=180]
      (C) [out=0,in=255]
      (D);
\tzslopeat[red,thick]{AA}{1}{3cm}
\tzslopeat[blue]{AA}{2}{2cm}
\tzslopeat{AA}{4}{2cm}{ $f'(4)$ }[r]
\tznormalat'[->,red,thick]{AA}{1}{3cm} %%
\tznormalat[->,blue]{AA}{2}{2cm}
\tznormalat'[->]{AA}{4}{2cm}{normal}[r] %%
\end{tikzpicture}
```

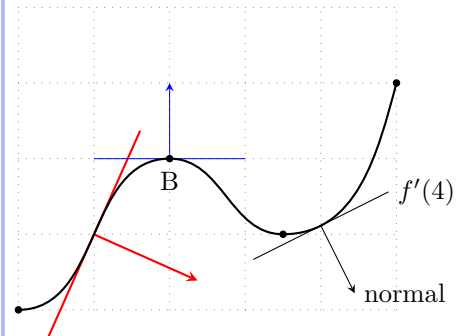

Remark: The swap version `\tznormalat'` has a fixed `[<rotate>]` value of `[-90]`.

- `\tznormalat{AA}{1}{3cm}[-90]` is equivalent to `\tznormalat'{AA}{1}{3cm}`.
- `\tznormalat'` does not change its direction with the option `[<rotate>]`.

25.4.3 `\tznormalat*(')`

```
% syntax: minimum
\tznormalat*{<path>}{<x-val>}{<length>}
% syntax: full
\tznormalat*{<opt>}{<path>}{<x-val>}(<epsilon1>,<epsilon2>){<length>}{<rotate>}
      {<text>}{<node opt>}<code.append>
% defaults
* [] {<m>}{<m>}{.01,.01}{<m>}[90]{} [] <>
*' [] {<m>}{<m>}{.01,.01}{<m>}[-90]{} [] <>
```

The starred version `\tznormalat*` works like `\tzslopeat`, but rotated `[90]`. And the swap version `\tznormalat*'` works like `\tzslopeat`, but rotated `[-90]`.

Remark: The swap version `\tznormalat*'` has a fixed `[<rotate>]` value of `[-90]`.

- `\tznormalat*{AA}{1}{3cm}[-90]` is equivalent to `\tznormalat*'{AA}{1}{3cm}`.
- `\tznormalat*'` does not change its direction with the option `[<rotate>]`.

```

% \tznormalat*(')
\begin{tikzpicture}
\tzhelplines*(5,4)
\tzcoors*(0,0) (A) (2,2) (B) {B} [b] (3.5,1) (C) (5,3) (D) ;
\tztos[thick]"AA"(A) [out=0,in=180]
      (B) [out=0,in=180]
      (C) [out=0,in=255]
      (D) ;
\tzslopeat[red,thick]{AA}{1}{3cm}
\tzslopeat[blue]{AA}{2}{2cm}
\tzslopeat{AA}{4}{2cm}{f'(4)}[r]
\tznormalat*[->,red,thick]{AA}{1}{3cm}
\tznormalat*[->,blue]{AA}{2}{2cm}
\tznormalat*'[->]{AA}{4}{2cm}{normal}[r]
\end{tikzpicture}

```

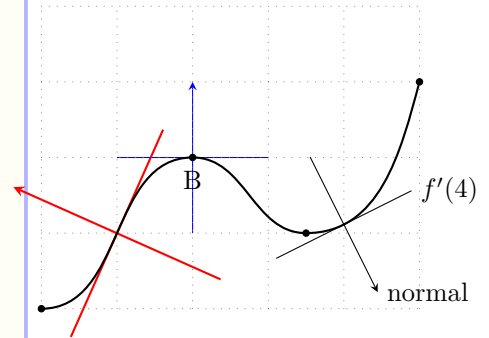

25.4.4 \tznormal

\tznormal is the same as \tznormalat, except for one thing. \tznormal uses a coordinate instead of a value of x to draw normal lines. So the mandatory arguments of \tznormal is {<path>}, (<coor>), and {<length>}. The y value of (<x,y>) is ignored.

```

% syntax: minimum
\tznormal{<path>}(<x,y>){<length>}
% syntax: full
\tznormal[<opt>]{<path>}(<x,y>)(<epsilon1>,<epsilon2>){<length>}[<angle>]
  {<text>}[<pos,opt>]<code.append>
% defaults
[] {<m>}(<m>)(.01,.01){<m>}[90]{}[]<>

```

```

% \tznormal
\begin{tikzpicture}
\tzhelplines*(5,4)
\tzcoors*(0,0) (A) (2,2) (B) {B} [b] (3.5,1) (C) (5,3) (D) ;
\tztos[thick]"AA"(A) [out=0,in=180]
      (B) [out=0,in=180]
      (C) [out=0,in=255]
      (D) ;
\tzslope[red]{AA}(1,0){3cm}
\tzgetxyval(B){\Bx}{\By}
\tzslopeat[blue]{AA}{\Bx}{2cm}
\tzslope{AA}(4,0){2cm}{f'(4)}[r]
\tznormal[->,blue]{AA}(1,0){2cm}
\tznormal[->,red]{AA}(B){2cm}
\tznormal[->,red]{AA}(4,0){2cm}{normal}[a]
\end{tikzpicture}

```

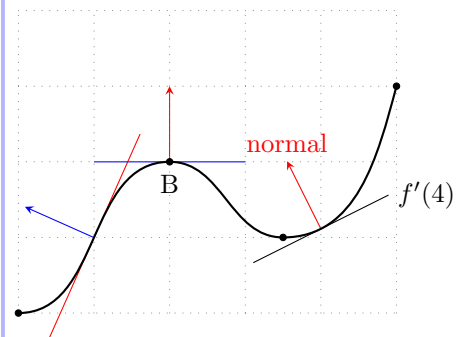

You can change its direction with the option [<rotate>] after the argument {<length>}.

```

% \tznormal: rotated
\begin{tikzpicture}
\tzhelplines*(5,4)
\tzcoors*(0,0) (A) (2,2) (B) {B} [b] (3.5,1) (C) (5,3) (D) ;
\tztos[thick]"AA"(A) [out=0,in=180]
      (B) [out=0,in=180]
      (C) [out=0,in=255]
      (D) ;
\tzslope[red]{AA}(B){3cm}
\tznormal[->,blue]{AA}(B){2cm}
\tznormal[->,blue]{AA}(B){2cm}[45]{45\textdegree}[ar]
\tznormal[->,blue]{AA}(B){2cm}[135]
\end{tikzpicture}

```

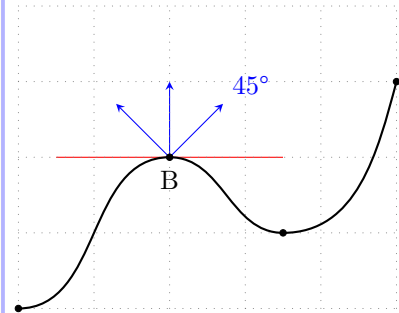

25.4.5 \tznormal'

The *swap version* \tznormal' draws a normal line with the opposite direction of \tznormal.

```

% syntax: minimim
\tznormal' {<path>}( <x,y>){<length>}
% syntax: full
\tznormal' [<opt>]{<path>}( <x,y>)( <epsilon1>, <epsilon2>){<length>}[<angle>]
      {<text>}[<pos,opt>]<code.append>
% defaults
[] {<m>}{<m>}( .01, .01){<m>}[ -90]{ } [ ] <>

```

Remark: The swap version \tznormal' has a fixed [rotate] value of [-90].

- \tznormal{AA}{1}{3cm}[-90] is equivalent to \tznormal'{AA}{1}{3cm}.
- \tznomral' does not change its direction with the option [rotate].

```

% \tznormal' (swap version)
\begin{tikzpicture}
\tzhelplines*(5,4)
\tzcoors*(0,0) (A) (2,2) (B) {B} [b] (3.5,1) (C) (5,3) (D) ;
\tztos[thick]"AA"(A) [out=0,in=180]
      (B) [out=0,in=180]
      (C) [out=0,in=255]
      (D) ;
\tzslope[red]{AA}(1,0){3cm}
\tzgetxyval(B){\Bx}{\By}
\tzslopeat[blue]{AA}{\Bx}{\By}{2cm}
\tzslope{AA}(4,0){2cm}{f'(4)}[r]
\tznormal' [->,blue]{AA}(1,0){2cm} %%
\tznormal[->,red]{AA}(B){2cm}
\tznormal' [->,red]{AA}(4,0){2cm}{normal}[b] %%
\end{tikzpicture}

```

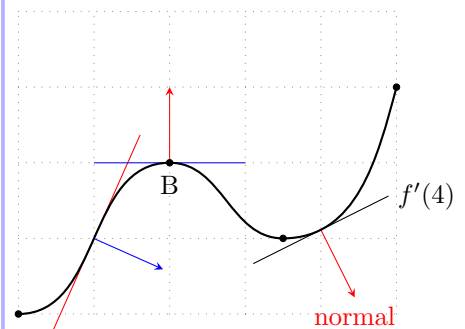

25.4.6 \tznormal*(')

The starred version \tznormal* works like \tzslope, but rotated [90]. And its swap version \tznormal*' works like \tzslope, but rotated [-90].

```

% syntax
\tznormal* [<opt>]{<path>}<(x,y)>(<epsilon1>,<epsilon2>){<length>}[<angle>]
    {<text>}[<pos,opt>]<code.append>
% defaults
* []{<m>}{<m>}(.01,.01){<m>}[90]{ }[]<>
* '[<m>]{<m>}(.01,.01){<m>}[-90]{ }[]<>

```

Remark: The swap version `\tznormal*'` has a fixed `[<rotate>]` value of `[-90]`.

- `\tznormal*{AA}{1}{3cm}[-90]` is equivalent to `\tznormal*' {AA}{1}{3cm}`.
- `\tznormal*'` does not change its direction with the option `[<rotate>]`.

```

% \tznormal*(')
\begin{tikzpicture}
\tzhelplines*(5,4)
\tzcoors*(0,0) (A) (2,2) (B) {B} [b] (3.5,1) (C) (5,3) (D);
\tztos[thick]"AA"(A) [out=0,in=180]
    (B) [out=0,in=180]
    (C) [out=0,in=255]
    (D);
\tzslopeat [red,thick]{AA}{1}{3cm}
\tzslopeat [blue]{AA}{2}{2cm}
\tzslopeat{AA}{4}{2cm}{f'(4)}[r]
\tznormal*[->,red,thick]{AA}(1,0){3cm}
\tznormal*[->,blue]{AA}(B){2cm}
\tznormal*' [->]{AA}(4,0){2cm}{normal}[r]
\end{tikzpicture}

```

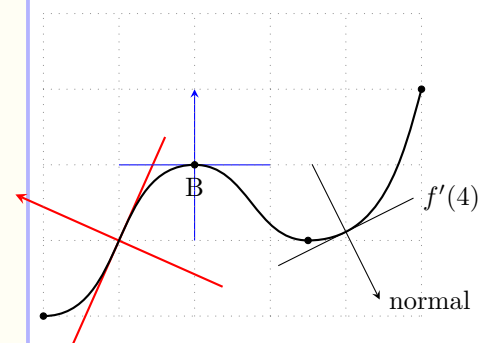

26 Miscellany

26.1 Middle arrows

Four styles for middle arrow tips are predefined: `-->--`, `--o--`, `--x--` and `--/--`.

26.1.1 Controllable middle arrow tips: `-->--` and `\settzmidarrow`

The middle arrow tip style `-->--` prints a middle arrow tip of `stealth` by default. It accepts one argument that changes the position (0.5 by default) of a *middle arrow tip*, like `-->--=.75`.

```
\begin{tikzpicture}
% middle arrow tip: -->--
\tzhelplines(4,3)
\tzline[-->--](0,3)(4,3)
\tzline[-->--=.75,blue,thick](0,2.5)(4,2.5)
\tzto[-->--,->,out=45](0,0)(4,1)
\end{tikzpicture}
```

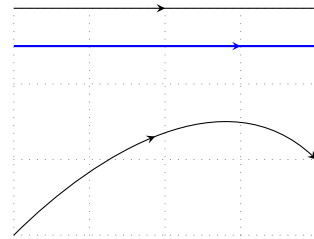

How to control middle arrow tips The default options for middle arrow tips are `-`, `thin`, `solid`, and `shorten >=0`, and `bend right=0`. The defaults can be changed by `\settzmidarrow`.

The macro `\settzmidarrow` controls the position, style, and other options of middle arrow tips. The effect is valid until the end of the `tikzpicture` environment, unless changed again.

```
% syntax:
\settzmidarrow<position>{<arrow tip style>}[<opt>]
% all arguments are optional
% defaults:
<0.5>{stealth}[-,thin,solid,shorten <=0,shorten >=0,bend right=0]
```

```
% \settzmidarrow
\begin{tikzpicture}
\tzhelplines(4,3)
\settzmidarrow<.25>{Stealth[reversed]}[red,scale=2] %
\tzline[-->--](0,3)(4,3)
\tzline[-->--=.75,blue,thick](0,2.5)(4,2.5)
\tzto[-->--,->,out=45](0,0)(4,1)
\end{tikzpicture}
```

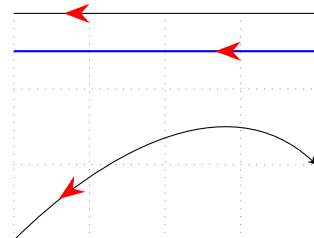

```
% various arrow tip styles: arrows.meta
\begin{tikzpicture}
\tzhelplines(4,3)
\settzmidarrow{Circle[open]}[blue,scale=2]
\tzline[-->--](0,3)(4,3)
\tikzset{>=to} %%
\settzmidarrow{>>>}[blue,scale=2]
\tzline[-->--](0,2.5)(4,2.5)
\settzmidarrow<.25>{Rays}[blue,scale=2]
\tzline[-->--=.75,blue,thick](0,2)(4,2)
\tzto[-->--,->,red,out=45](0,0)(4,1)
\end{tikzpicture}
```

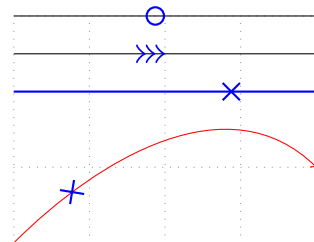

You can use various styles of arrow tips. (See TikZ manual on `arrows.meta` library, for more details.)

26.1.2 Fixed middle arrow tip styles: --o--, --x--, --/--

Three styles for middle arrow tips are predefined: *circle* --o-- , *cross* --x-- , and *diagonal* --/-- middle arrow tips. These middle arrow tip styles are fixed and cannot be changed. `\settzmidarrow` can only be used with [`<opt>`] to control these middle arrow tips. The other options `<position>` and `{<arrow tip style>}` options are ignored for these styles.

Circle middle arrow tips: The circle middle arrow tip style --o-- takes one argument to change the position (0.5 by default).

The circle is drawn like this:

```
\draw [<opt>] (0,0) circle (1.2pt) ;
```

`\settzmidarrow` controls the circle arrow tip with `<opt>`.

```
\begin{tikzpicture}
% circle middle arrow tip: --o--
\tzhelplines(4,3)
\tzline[--o--] (0,3) (4,3)
\tzline[--o--=.75,blue,thick] (0,2.5) (4,2.5)
\tzto[--o--,->,out=45] (0,0) (4,1)
\end{tikzpicture}
```

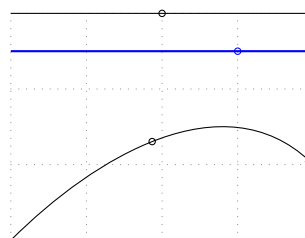

```
\begin{tikzpicture}
% \settzmidarrow: difference
\tzhelplines(4,3)
\settzmidarrow<.25>{Circle[open,fill=green]}[scale=2] %
\tzline[--o-- ,thick] (0,3) (4,3)
\tzline[-->--=.5,blue,thick] (0,2.5) (4,2.5)
\tzline[-->-- ,blue,thick] (0,2) (4,2)
\settzmidarrow[scale=2,thick,fill=green]
\tzto[--o--=.25,->,out=45] (0,0) (4,1)
\end{tikzpicture}
```

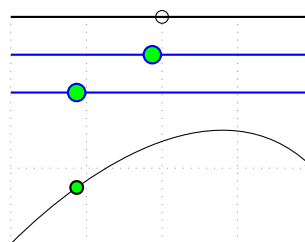

Cross middle arrow tips: The cross middle arrow tip style --x-- takes one argument to change the position (0.5 by default).

The cross mark is drawn like this:

```
\draw [<opt>] (2pt,2pt) to (-2pt,-2pt) ;
\draw [<opt>] (-2pt,2pt) to (2pt,-2pt) ;
```

`\settzmidarrow` controls the cross arrow tip with `<opt>`.

```
\begin{tikzpicture}
% cross middle arrow tip: --x--
\tzhelplines(4,3)
\tzline[--x--] (0,3) (4,3)
\tzline[--x--=.75,blue,thick] (0,2.5) (4,2.5)
\tzto[--x--,->,out=45] (0,0) (4,1)
\end{tikzpicture}
```

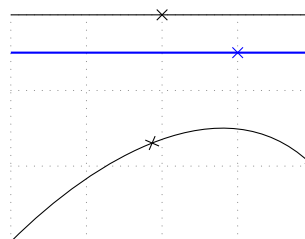

```

\begin{tikzpicture}
% \settzmidarrow: scale, tzextend
\tzhelplines(4,3)
\settzmidarrow<.25>{Rays[red]}[scale=2] %
\tzline[--x--,thick] (0,3) (4,3)
\tzline[-->---.5,blue,thick] (0,2.5) (4,2.5)
\tzline[-->--,blue,thick] (0,2) (4,2)
\settzmidarrow[thick,blue,tzextend={8pt}{8pt}]
\tzto[--x---.25,->,out=45] (0,0) (4,1)
\end{tikzpicture}

```

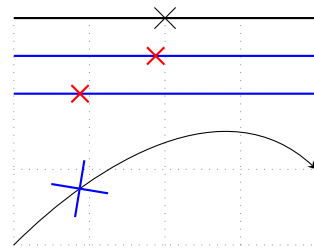

Diagonal middle arrow tips The diagonal middle arrow tip style `--/--` takes one argument to change the position (0.5 by default).

The diagonal line is drawn like this:

```
\draw [<opt>] (2pt,2pt) to (-2pt,-2pt) ;
```

`\settzmidarrow` controls the diagonal arrow tip line with `[<opt>]`.

```

\begin{tikzpicture}
% diagonal middle arrow tip: --/--
\tzhelplines(4,3)
\tzline[--/--] (0,3) (4,3)
\tzline[--/--=.75,blue,thick] (0,2.5) (4,2.5)
\tzto[--/--,->,out=45] (0,0) (4,1)
\end{tikzpicture}

```

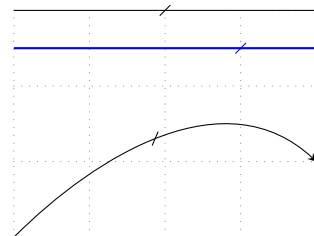

```

\begin{tikzpicture}
% \settzmidarrow: rotate, tzextend
\tzhelplines(4,3)
\tzline[--/--,thick] (0,3) (4,3)
\tzline[--/--=.25,blue,thick] (0,2.5) (4,2.5)
\settzmidarrow[rotate=90,red,tzextend={3pt}{3pt}]
\tzline[--/--,blue,thick] (0,2) (4,2)
\tzto[--/--=.75,->,out=45] (0,0) (4,1)
\end{tikzpicture}

```

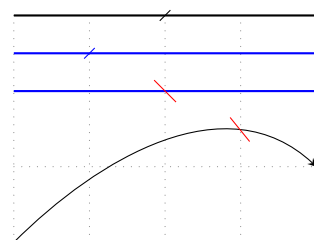

```

\begin{tikzpicture}
% \settzmidarrow: bend left
\tzhelplines(4,3)
\settzmidarrow[scale=2,rotate=45,bend left=60]
\tzline[--/--,thick] (0,3) (4,3)
\tzline[--/--=.25,blue,thick] (0,2.5) (4,2.5)
\settzmidarrow[rotate=90,red,tzextend={3pt}{3pt}]
\tzline[--/--,blue,thick] (0,2) (4,2)
\tzto[--/--=.75,->,out=45] (0,0) (4,1)
\end{tikzpicture}

```

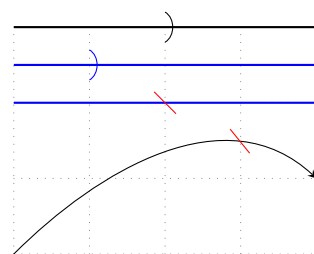

26.2 `\tzbrace(')`

`\tzbrace` takes two coordinates as mandatory arguments to draw a *calligraphic brace* connecting them.

```

% syntax: minimum
\tzbrace(<coor>)(<coor>)
% syntax: medium
\tzbrace(<coor>)(<coor>){<text>}[<node opt>]
% syntax: full
\tzbrace[<draw opt>]{<raise>}[<decoration opt>]<shift coor>
    (<coor>)(<coor>){<text>}[<node opt>]
% defaults
[] {5pt} [amplitude=5pt] <> (<m>) (<m>) {} []

```

The `raise` value of a brace is 5pt by default and the value can be changed by the first curly brace optional argument `{<raise>}`.

The `amplitude` of a brace is 5pt by default. You can control the amplitude by writing the option `amplitude=<dim>` in the second bracket option `[<decoration opt>]`.

```

\tzbrace[thick](0,0)(3,1) % works like:
\draw [thick,decorate,decoration={calligraphic brace, amplitude=5pt, raise=5pt}]
    (0,0) to (3,1);

```

The *swap version* `\tzbrace'` swaps the coordinates. So it prints a mirror image of `\tzbrace`. For example, `\tzbrace'(0,0)(3,1)` is equivalent to `\tzbrace(3,1)(0,0)`.

```

% \tzbrace(')
\begin{tikzpicture}[sloped]
\tzhelplines(4,2)
\tzline(0,0)(3,1)
\tzbrace(0,0)(3,1){AAA}[above=10pt,blue]
\tzbrace'[red](0,0)(3,1){BBB}[below=10pt]
\end{tikzpicture}

```

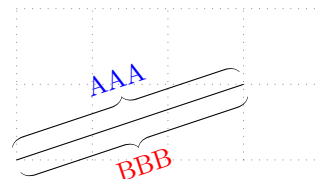

You can change the style of the decorating brace by the second bracket optional argument `[<decoration opt>]`.

The color of the calligraphic brace can be changed by the option `pen colour` in the list of `[<draw option>]`.

```

% \tzbrace('): decoration options
\begin{tikzpicture}[sloped]
\tzhelplines(4,3)
\tzline(0,0)(3,1)
\tzbrace [very thick,pen colour=blue]
    [amplitude=10pt]
    (0,0)(3,1){AAA}[a=15pt]
\tzbrace'[red,very thick]{10pt}
    [brace,amplitude=10pt]
    (0,0)(3,1){BBB}[b=20pt]
\end{tikzpicture}

```

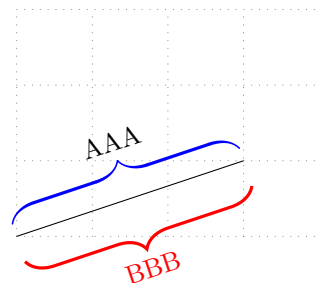

You can also move a brace by specifying the option `<shift coor>` immediately before the the first mandatory coordinate. The empty shift option `<>` is not allowed.

```

% \tzbrace('): shift
\begin{tikzpicture}[sloped]
\tzhelplines(4,3)
\tzline(0,0)(3,1)
\tzbrace [very thick,pen colour=blue][amplitude=10pt]
<.5,.5>(0,0)(3,1){AAA}[a=15pt]
\tzbrace'[red,very thick]{10pt}[brace,amplitude=10pt]
(0,0)(3,1){BBB}[b=20pt]
\end{tikzpicture}

```

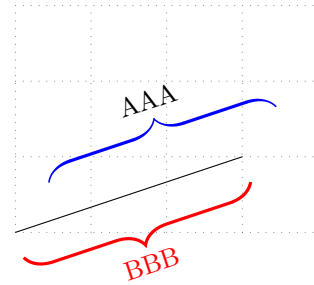

26.3 \tzsnake(+): Snake lines (Experimental)

\tzsnake connects two points with a snaked line, with many default values, using TikZ's to operation.

```

\tzsnake(0,1)(3,2) % works like
\draw [decorate , decoration={ %% many defaults
snake,
segment length=5pt, % controlled by \tzsnake
amplitude=2.5pt,
pre length=5pt,
post length=5pt
}
] (0,1) to (3,2) ;

```

```

\begin{tikzpicture}
\tzhelplines(4,3)
\tzsnake(0,1)(3,2)
\tzsnake[->,blue,bend right](1,0)(4,3)
\end{tikzpicture}

```

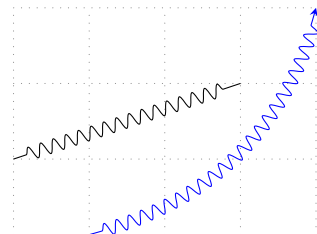

```

% syntax: minimum
\tzsnake(<coor>)(<coor>)
% syntax: full
\tzsnake[<opt>]{<segment length>}[<decoration opt>]<shift coor>
(<coor>){<text>}[<node opt>]
(<coor>){<text>}[<node opt>]<code.append>
% defaults
[] {5pt} [many defaults above] <> (<m>) {} [] (<m>) {} [] <>

```

The key `segment length` is controlled by the first curly brace option and you should write down all the other keys in the second bracket option [`<decoration opt>`] to change the values. Not specifying the option `{<segment length>}`, when the first bracket option is empty, you need empty brackets [], like `\tzsnake[] [<decoration opt>] . . .`

```

% \tzsnake: {segment length} option
\begin{tikzpicture}
\tzhelplines(4,3)
\tzsnake[blue]{3pt}[coil] (0,1){spring}[a,sloped] (3,2)
\tzsnake[->,bend right]{3pt}
      [coil,amplitude=5pt,post length=20pt]
      (1,0){coil line}[b,sloped] (4,3){Up!}[draw,r]
\end{tikzpicture}

```

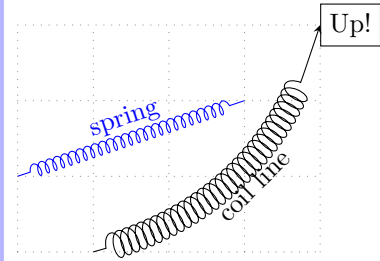

The plus version `\tzsnake+` uses the second mandatory coordinate as a relative coordinate to the first. Everything else is the same as in `\tzsnake`.

```

% \tzsnake(+): shift
\begin{tikzpicture}
\tzhelplines(4,3)
\tzsnake[->][post length=20pt] (0,0) (3,0)
\tzsnake[->,red][post length=20pt]<1,1>(0,0) (3,0) %%
\tzsnake+[->,bend left,blue]{10pt}[post length=10pt]
      (0,1){snake line}[a,sloped] (4,2){what?}[r]
\end{tikzpicture}

```

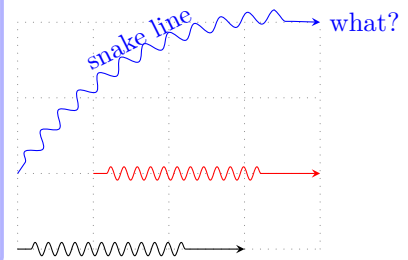

Version history

- v2.11 (2022/10/04)
 - added `\tzcoortangenttocircle(*)` to find the tangent coordinates to a circle
 - redesigned `\tznodecircle(*)`
 - * added the options: "`<path name>`" and `(<minimum size>)`
 -
- v2.1 (2022/09/28)
 - Uploaded to CTAN
 - document done
- v2.1 (2022/09/24)
 - fixed bugs: `\tzplot`, `\tzplotcurve`, `\tzslope`
 - redesigned `\tzaxes` to have one path with “liftpen” for naming paths
 - redesigned `\tzaxesL` to have one path with “liftpen” for naming paths
 - redesigned `\tzslopeat` and `\tzslope`
 - added the swap versions `\tzslopeat'` and `\tzslope'`
 - added `\tznormal(*)(')`, `\tznormalat(*)(')`, `\setztznormalepsilon` and `\setztznormallayer`
- v2.1 (2022/04/15)
 - modified `\tzaxisx` and `\tzaxisy` to add the option "`<path name>`"
 - added `\tzdistance` to calculate the distance between two coordinates
- v2.0 (2022/02/28)
 - Uploaded to CTAN
- v1.0.1 (2021/03/20) uploaded to CTAN
 - revised the document with typo corrections
 - added the option `<code.append>` to `\tzframe`, `\tzcircle`, and `\tzellipse`
 - added aliases: `\let\tzrectangle\tzframe` and `\let\tzoval\tzellipse`
- v1.0 (2021/02/28) uploaded to CTAN

Acknowledgement

Many thanks to Kangsoo Kim from KTUG (Korean TeX Users Group) who wrote many packages, including `oblivoir.cls`, for helping to implement the semicolon versions and to handle TeX expansion issues using `expl3`.

References

- Casteleyn, Jean Pierre (2016), “Visual PSTricks,” version 2.30.
(2018), “Visual TikZ,” version 0.66.
- Tantau, Till (2021), “TikZ and PGF: Manual for version 3.1.9a,” <http://sourceforge.net/projects/pgf>.

Index

【 Symbols 】

--/-- 193
-->-- 191
--o-- 192
--x-- 192
<m> 40, 42, 46, 139

【 A 】

abbreviations 2, 12

【 B 】

bounding box 23, 40, 140

【 C 】

clockwise 126, 129
counterclockwise 126, 129
current bounding box 28, 158, 160
current subpath start 157

【 E 】

elliptical arc 127
envelope curve 170
error message 5, 15, 44, 162, 164
even odd rule 118, 121, 122, 124

【 H 】

horizontal intersection 174, 175

【 I 】

intersection 171
inverse function 153, 157, 162, 163

【 L 】

label node 11, 47, 49, 51, 68

【 M 】

main node 11, 12, 47, 49, 51, 68
middle arrow tip 5, 191

【 N 】

node coordinate 67, 68
normal distribution 166
normal line 183

【 P 】

plus version 81, 85, 89, 92, 93, 97, 103, 106,
109
probability density function 166

【 S 】

secant 176, 178
semicolon version 5, 15, 44, 49, 95, 100
\settzAAlinestyle 132
\settzAAradius 132
\settzanglelayer 132, 134–136
\settzanglemarklayer 136
\settzcdotradius 43, 45

\settzdotsize 47, 50, 77
\settzfillcolor 75, 102, 136
\settzfillopacity 75, 102, 136
\settzfnarealayer 167, 168
\settzfnarealinstyle 168
\settzlinkstyle 92, 93, 96
\settzmarksize 59
\settzmidarrow 5, 191
\settznormalepsilon 186
\settzpathlayer 101
\settzpathstyle 101
\settzRALinestyle 135
\settzRAsize 135
\settzsecantlayer 176, 178
\settzslopeepsilon 182
\setztangentepsilon 181
\setztangentlayer 179
\setzttnormallayer 185
\setzttslopelayer 182
string replacement 5
swap version 126, 127, 129, 130, 133, 134,
144, 153, 157, 162, 163, 184–186,
189, 194

【 T 】

tangent 58, 77, 179, 181
THREE WAYS 46
(tzAamid) 133
\tzanglemark' 133
\tzanglemark 132
\tzanglemark*' 134
\tzanglemark* 134
\tzangleONE 132
\tzangleresult 132
\tzangleTWO 132
\tzarc' 126
\tzarc 125
\tzarcfrom' 127
\tzarcfrom 127
\tzarcsfrom 128
\tzaxes 23, 139
\tzaxes* 23, 140, 158
\tzaxesL' 144
\tzaxesL 144
\tzaxisx 24, 141
\tzaxisy 24, 141
\tzbbox 41, 158
\tzbezier 10, 14, 104
\tzbezier+ 106
\tzbezierAtBegin 106
\tzbezierAtEnd 106
\tzbox 117
\tzbox* 117
\tzbox** 117
\tzbox+ 117

<code>\tzboxring</code>	120	<code>\tzframe</code>	117
<code>\tzboxring*</code>	120	<code>\tzframe*</code>	117
<code>\tzbrace'</code>	194	<code>\tzframe**</code>	117
<code>\tzbrace</code>	193	<code>\tzframe+</code>	117
<code>tzcdot</code>	45	<code>\tzframering</code>	120
<code>\tzcdot</code>	7, 42	<code>\tzframering*</code>	120
<code>\tzcdot*</code>	7, 42	<code>\tzgetxyval</code>	57
<code>\tzcdots</code>	18, 44	<code>tzhelplines</code>	40
<code>\tzcdots*</code>	18, 44	<code>\tzhelplines</code>	40
<code>\tzcircle</code>	120	<code>\tzhelplines*</code>	40, 158
<code>\tzcircle*</code>	120	<code>\tzhfn</code>	28, 159
<code>\tzcirclering</code>	123	<code>\tzhfnat</code>	28, 158
<code>\tzcirclering*</code>	123	<code>\tzhfnatAtBegin</code>	159
<code>\tzcoor</code>	9, 12, 52	<code>\tzhfnatAtEnd</code>	159
<code>\tzcoor*</code>	9, 13, 53	<code>\tzhfnAtBegin</code>	160
<code>\tzcoors</code>	19, 54	<code>\tzhfnAtEnd</code>	160
<code>\tzcoors*</code>	20, 55	<code>\tzhXpoint</code>	31, 175
<code>\tzcoorsquick</code>	20, 56	<code>\tzhXpoint*</code>	31, 175
<code>\tzcoorsquick*</code>	20, 56	<code>\tzhXpointat</code>	30, 174
<code>\tzcoortangenttocircle</code>	58, 77	<code>\tzhXpointat*</code>	30, 174
<code>\tzcoortangenttocircle*</code>	58, 77	<code>\tzLFn'</code>	162
<code>tzdashed</code>	40	<code>\tzLFn</code>	29, 161
<code>\tzdefLFn</code>	164	<code>\tzLFnAtBegin</code>	162
<code>\tzdefLFnofy</code>	164	<code>\tzLFnAtEnd</code>	162
<code>\tzdistance</code>	137	<code>\tzLFnofy'</code>	163
<code>tzdot</code>	46, 50, 77	<code>\tzLFnofy</code>	163
<code>\tzdot</code>	8, 46	<code>\tzLFnofyAtBegin</code>	163
<code>\tzdot*</code>	8, 46	<code>\tzLFnofyAtEnd</code>	163
<code>\tzdots</code>	18, 49	<code>\tzLFnXpoint</code>	175
<code>\tzdots*</code>	18, 49	<code>\tzLFnXpoint*</code>	176
<code>tzdotted</code>	40	<code>\tzline</code>	13, 78
<code>\tzedge</code>	110	<code>\tzline+</code>	81
<code>\tzedge+</code>	110	<code>\tzlineAtBegin</code>	80
<code>\tzedges</code>	111	<code>\tzlineAtEnd</code>	80
<code>\tzedges+</code>	112	<code>\tzlines</code>	15, 82
<code>\tzellipse</code>	123, 124	<code>\tzlines+</code>	85
<code>\tzellipse*</code>	123, 124	<code>\tzlinesAtBegin</code>	85
<code>tzextend</code>	82	<code>\tzlinesAtEnd</code>	85
<code>\tzfn'</code>	153	<code>\tzlink</code>	92
<code>\tzfn</code>	27, 114, 153	<code>\tzlink+</code>	93
<code>\tzfnarea</code>	167	<code>\tzlinkAtBegin</code>	95
<code>\tzfnarea*</code>	167	<code>\tzlinkAtEnd</code>	95
<code>\tzfnarealine'</code>	169	<code>\tzlinks</code>	95
<code>\tzfnarealine</code>	168	<code>\tzlinks*</code>	97
<code>\tzfnAtBegin</code>	156	<code>\tzlinks**</code>	97
<code>\tzfnAtEnd</code>	156	<code>\tzlinks+</code>	97
<code>\tzfnmax</code>	170	<code>\tzlinksAtBegin</code>	100
<code>\tzfnmaxAtBegin</code>	170	<code>\tzlinksAtEnd</code>	100
<code>\tzfnmaxAtEnd</code>	170	<code>tzmark</code>	58
<code>\tzfnmin</code>	170	<code>\tzmarksiz</code>	59
<code>\tzfnminAtBegin</code>	171	<code>\tznode</code>	11, 67
<code>\tzfnminAtEnd</code>	171	<code>\tznode*</code>	11, 67
<code>\tzfnofy'</code>	157	<code>\tznodebox</code>	75
<code>\tzfnofy</code>	157	<code>\tznodebox*</code>	75
<code>\tzfnofyAtBegin</code>	158	<code>\tznodecircle</code>	75
<code>\tzfnofyAtEnd</code>	158	<code>\tznodecircle*</code>	75

<code>\tznodedot</code>	71	<code>\tzproj</code>	27, 149
<code>\tznodedot*</code>	71	<code>\tzproj*</code>	27, 149
<code>\tznodedots</code>	72	<code>\tzprojs</code>	151
<code>\tznodedots*</code>	72	<code>\tzprojs*</code>	151
<code>\tznodeellipse</code>	78	<code>\tzprojx</code>	26, 150
<code>\tznodeellipse*</code>	78	<code>\tzprojx*</code>	26, 150
<code>\tznodeframe</code>	74	<code>\tzprojy</code>	150
<code>\tznodeframe*</code>	75	<code>\tzprojy*</code>	150
<code>\tznodeoval</code>	78	<code>(tzRAvertex)</code>	135
<code>\tznodeoval*</code>	78	<code>\tzrectangle</code>	117
<code>\tznoderectangle</code>	75	<code>\tzrectangle*</code>	117
<code>\tznoderectangle*</code>	75	<code>\tzrectangle**</code>	117
<code>\tznodes</code>	69	<code>\tzrectangle+</code>	117
<code>\tznodes*</code>	70	<code>\tzrectanglering</code>	119
<code>\tznormal'</code>	189	<code>\tzrectanglering*</code>	118
<code>\tznormal</code>	188	<code>\tzrightanglemark</code>	135
<code>\tznormal*'</code>	189	<code>\tzrightanglemark*</code>	136
<code>\tznormal*</code>	189	<code>\tzring</code>	122
<code>\tznormalat'</code>	186	<code>\tzring*</code>	121
<code>\tznormalat</code>	185	<code>\tzsecant</code>	32, 178
<code>\tznormalat*'</code>	187	<code>\tzsecantat</code>	32, 176
<code>\tznormalat*</code>	187	<code>tzshorten</code>	82
<code>\tzoval</code>	124	<code>tzshowcontrols</code>	105
<code>\tzoval*</code>	124	<code>\tzshoworigin</code>	24, 142
<code>\tzovalring</code>	125	<code>\tzshoworigin*</code>	24, 143
<code>\tzovalring*</code>	125	<code>\tzslope'</code>	185
<code>\tzparabola</code>	10, 107	<code>\tzslope</code>	184
<code>\tzparabola+</code>	109	<code>\tzslopeat'</code>	184
<code>\tzparabolaAtBegin</code>	109	<code>\tzslopeat</code>	182
<code>\tzparabolaAtEnd</code>	109	<code>\tzsnake</code>	195
<code>\tzpath</code>	17, 100	<code>\tzsnake+</code>	196
<code>\tzpath*</code>	17, 102	<code>\tztangent</code>	31, 181
<code>\tzpath**</code>	103	<code>\tztangentat</code>	31, 179
<code>\tzpath+</code>	103	<code>\tzticks</code>	25, 145
<code>\tzpdfN</code>	166	<code>\tzticks*</code>	25, 147
<code>\tzpdfN*</code>	166	<code>\tzticksx</code>	26, 147
<code>\tzpdfZ</code>	166	<code>\tzticksx*</code>	26, 148
<code>\tzplot</code>	21, 58	<code>\tzticksy</code>	26, 148
<code>\tzplot*</code>	21, 22	<code>\tzticksy*</code>	26, 148
<code>\tzplotAtBegin</code>	61, 63	<code>\tzto</code>	10, 14, 87
<code>\tzplotAtEnd</code>	61, 63	<code>\tzto+</code>	89
<code>\tzplotcurve</code>	22, 64	<code>\tztoAtBegin</code>	88
<code>\tzplotcurve*</code>	64	<code>\tztoAtEnd</code>	88
<code>\tzplotcurveAtBegin</code>	66	<code>\tztos</code>	89
<code>\tzplotcurveAtEnd</code>	66	<code>\tztos+</code>	92
<code>\tzpointangle</code>	131	<code>\tztosAtBegin</code>	92
<code>\tzpolygon</code>	16, 115	<code>\tztosAtEnd</code>	92
<code>\tzpolygon*</code>	116	<code>\tzvfn</code>	28, 161
<code>\tzpolygon**</code>	116	<code>\tzvfnat</code>	28, 160
<code>\tzpolygon+</code>	116	<code>\tzvfnatAtBegin</code>	160
<code>\tzproj</code>	27, 149	<code>\tzvfnatAtEnd</code>	160
<code>\tzproj*</code>	27, 149	<code>\tzvfnAtBegin</code>	161
<code>\tzprojs</code>	151	<code>\tzvfnAtEnd</code>	161
<code>\tzprojs*</code>	151	<code>\tzvfnAtEnd</code>	161
<code>\tzprojx</code>	152	<code>\tzvXpoint</code>	30, 173
<code>\tzprojx*</code>	152	<code>\tzvXpoint*</code>	30, 173
<code>\tzprojy</code>	150	<code>\tzvXpointat</code>	30, 172
<code>\tzprojy*</code>	150	<code>\tzvXpointat*</code>	30, 173
<code>(tzRAvertex)</code>	135	<code>\tzwedge'</code>	129
<code>\tzrectangle</code>	117		
<code>\tzrectangle*</code>	117		
<code>\tzrectangle**</code>	117		
<code>\tzrectangle+</code>	117		
<code>\tzrectanglering</code>	119		
<code>\tzrectanglering*</code>	118		
<code>\tzrightanglemark</code>	135		
<code>\tzrightanglemark*</code>	136		
<code>\tzring</code>	122		
<code>\tzring*</code>	121		
<code>\tzsecant</code>	32, 178		
<code>\tzsecantat</code>	32, 176		
<code>tzshorten</code>	82		
<code>tzshowcontrols</code>	105		
<code>\tzshoworigin</code>	24, 142		
<code>\tzshoworigin*</code>	24, 143		
<code>\tzslope'</code>	185		
<code>\tzslope</code>	184		
<code>\tzslopeat'</code>	184		
<code>\tzslopeat</code>	182		
<code>\tzsnake</code>	195		
<code>\tzsnake+</code>	196		
<code>\tztangent</code>	31, 181		
<code>\tztangentat</code>	31, 179		
<code>\tzticks</code>	25, 145		
<code>\tzticks*</code>	25, 147		
<code>\tzticksx</code>	26, 147		
<code>\tzticksx*</code>	26, 148		
<code>\tzticksy</code>	26, 148		
<code>\tzticksy*</code>	26, 148		
<code>\tzto</code>	10, 14, 87		
<code>\tzto+</code>	89		
<code>\tztoAtBegin</code>	88		
<code>\tztoAtEnd</code>	88		
<code>\tztos</code>	89		
<code>\tztos+</code>	92		
<code>\tztosAtBegin</code>	92		
<code>\tztosAtEnd</code>	92		
<code>\tzvfn</code>	28, 161		
<code>\tzvfnat</code>	28, 160		
<code>\tzvfnatAtBegin</code>	160		
<code>\tzvfnatAtEnd</code>	160		
<code>\tzvfnAtBegin</code>	161		
<code>\tzvfnAtEnd</code>	161		
<code>\tzvXpoint</code>	30, 173		
<code>\tzvXpoint*</code>	30, 173		
<code>\tzvXpointat</code>	30, 172		
<code>\tzvXpointat*</code>	30, 173		
<code>\tzwedge'</code>	129		

`\tzwedge` 129
`\tzwedge*` 130
`\tzwedge*` 130
`\tzXpoint` 29, 171
`\tzXpoint*` 30, 172

[U]
`\useasboundingbox` 158

[V]
vertical intersection 172, 173